

LED Driver

LNA ARENA SPORT 1.6KW Series

LNA ARENA SPORT

Highlights & Features



- 3 independent programmable output channels
- Configurable channel address mode (1*DT6 / 1*DMX or 3*DT6 / 3*DMX)
- Max. output power 1650W (3x550W/channel)
- Input voltage range: 187~528VAC
- High Efficiency up to 97.5%
- Programmable output current range 700-2000 mA
- Output voltage range 150-550Vdc per channel
- Built-in 2 in 1: DALI-2 & D4i and RDM/DMX communication protocols
- Wide dimming range 0.1%-100%
- Low current ripple (typ.1%) suitable for HDTV broadcasting
- Strobe effects up to 33 fps
- After-glow effect free
- Common output design (V1+=V2+=V3+)
- Constant Lumen Output (CLO)
- Smart Timer Dimming (STD)
- High-accuracy integrated power metering
- Max remote distance up to 300 meters
- Input surge protection: DM 10kV / CM 10kV

Standards & Marks



Model Number: LNA-1K6C20ABFGB□□
Unit Weight: 5.6kg
Dimensions (L x W x H): 500 x 152 x 77 mm

General Description

The LNA-1K6C20ABFGB series is a constant current IP66 LED driver with 3 independent programmable channels, that operates with an input voltage range of 187~528Vac. It is specially designed for Sports Lighting applications but also for many other lighting applications, including industrial, high mast, and horticulture, etc. The dimming control supports two-way communication via DALI-2 & D4i, and it also incorporates RDM/DMX dimming function. This driver was specifically conceived and intended to offer remarkably high efficiency to achieve substantial energy savings. Additionally, a wide dimming range, advanced control, and smart timer dimming (STD) ensure adaptability for dynamic atmospheres and seamless scenes adjustments. The LNA-1K6C20ABFGB driver offers a remote-control function, allowing the driver to be installed up to 300 meters from the luminaire, which provides greater flexibility in installation, operation, and easy maintenance.

Model Information

Model Number	Input Voltage Range	Rated Output Power	Output Channel ¹	Control Interface ²
LNA-1K6C20ABFGB	208~480Vac (nominal) 187~528Vac (range)	1650W	3	DALI-2 & D4i, and RDM/DMX

1. The driver has been configured for single address mode by default, the user can also switch to other channel address modes through the GUI and programming tools.
2. The split DALI and DMX interface terminals are mounted in the junction box.

Model Numbering

LN	A	-	1K6	C	□□	A	B	F	G	B	□□
LED Driver	Arena Sport	/	Output power 1K6:1650 W	No. of Outputs: C: 3 channels	Output current 20:2000mA	Constant Current	Input voltage: 187-528Vac	Programmable via Delta tool	Dimming: G: DALI-2 & D4i and RDM/DMX	Die-casting	Mode series: 0~9, A~Z or blank.

LED Driver

LNA ARENA SPORT 1.6KW Series

Specifications

Input Ratings / Characteristics

Specification	Min.	Typ.	Max.	Test Conditions / Notes
Nominal Input Voltage	208Vac	-	480Vac	
Input Voltage Range	187Vac	-	528Vac	
Nominal Input Frequency	-	50/60Hz	-	
Input Frequency Range	47Hz	-	63Hz	
Nominal Input Current	-	7.8A	-	At 220Vac, 25°C, 500V/1.2A @ Pout=1650W
	-	6.2A	-	At 277Vac, 25°C, 500V/1.2A @ Pout=1650W
	-	4.3A	-	At 400Vac, 25°C, 500V/1.2A @ Pout=1650W
	-	3.6A	-	At 480Vac, 25°C, 500V/1.2A @ Pout=1650W
Efficiency ³	-	96.6%	-	At 220Vac, 25°C, 500V/1.2A @ Pout=1650W
	-	97.0%	-	At 277Vac, 25°C, 500V/1.2A @ Pout=1650W
	-	97.3%	-	At 400Vac, 25°C, 500V/1.2A @ Pout=1650W
	-	97.2%	-	At 480Vac, 25°C, 500V/1.2A @ Pout=1650W
Standby Power Consumption	-	-	0.5W	At 230Vac/50Hz, Output and DALI bus power supply are in OFF status, in compliance with Erp(EU) 2019/2020
Power Factor	-	0.99	-	At 220Vac/50Hz, 25°C, 1650W output
	-	0.99	-	At 277Vac/60Hz, 25°C, 1650W output
	-	0.98	-	At 400Vac/50Hz, 25°C, 1650W output
	-	0.97	-	At 480Vac/60Hz, 25°C, 1650W output
Total Harmonic Distortion	-	8%	-	At 220Vac/50Hz, 25°C, 1650W output
	-	8%	-	At 277Vac/60Hz, 25°C, 1650W output
	-	11.5%	-	At 400Vac/50Hz, 25°C, 1650W output
	-	13.5%	-	At 480Vac/60Hz, 25°C, 1650W output
Inrush Current	-	8A	-	At 220Vac, 50%Apk to 50%Apk time: 2ms
	-	9A	-	At 277Vac, 50%Apk to 50%Apk time: 2ms
	-	12A	-	At 400Vac, 50%Apk to 50%Apk time: 2ms
	-	14A	-	At 480Vac, 50%Apk to 50%Apk time: 2ms
Power metering accuracy	-	±1%	±2%	At 208Vac~480Vac, Voltage, current, PF, frequency, active power, apparent power, etc. on the AC side, Full load

3. 100% Load and tested after 30 minutes warming up.

LED Driver

LNA ARENA SPORT 1.6KW Series

Output Ratings / Characteristics

Specification		Min.	Typ.	Max.	Test Conditions / Notes
Output Channels		-	3	-	3 independent and individually controllable output channels, and single address for all channels by default.
Total Output Power		-	-	1650W	All channels
Output Power Range		-	-	550W	Per Output Channel
Default Output Current		-	1200mA	-	
Programmable Output Current Range		700mA	-	2000mA	Operation range refer to Appendix 1
Output Current Tolerance		-	-	±3%	Range from 700 to 2000mA
Output Voltage Range		150V	-	550V	All operating conditions shall not exceed this voltage range
Output Current Ripple		-	1%	2%	(ripple = (pk-pk)/avg), at low frequency(<8kHz)
		-	5%	20%	(ripple = (pk-pk)/avg), at high frequency(>15kHz)
Strobe Effects ⁴		-	-	33 fps	Supports a continuous sequence as fast as 30ms-ON and 30ms-OFF (fps means frame per second)
Output Remote Distance		-	-	300m	The distance is related to the actual application conditions, but the voltage in the driver side shall not exceed 550V.
Turn on Delay Time	DALI version	-	0.7s	1s	Clause 9.13 of IEC 62386-102:2014, 10%~100% load.
	RDM/DMX version	-	0.7s	1s	Clause 3.5 of ANSI E1.37-1:2012, connecting to the controller correctly, 10%~100% load.
		1.25s	-	-	Clause 3.5 of ANSI E1.37-1:2012, No controller or incorrect connection to the controller, 10%~100% load.

4. In the Strobe mode, the OFF period should be within 5s in general, otherwise please refer to "LNA/EUCO Series Programming Tool User Manual" for more details to make a requisite configuration.

Auxiliary Power Supply Ratings / Characteristics

Specification		Min.	Typ.	Max.	Test Conditions / Notes
Integrated 24V Auxiliary Power Supply					
Operating Voltage		21.6V	24.0V	26.4V	0.1W~6.0W, the ground is "DA-".
High frequency ripple of operating voltage		-	-	1.0 V _{pp}	21.6V~26.4V, f _{ripple} > 10kHz
Voltage in no-load condition		-	-	30.0V	Output power < 0.1W
Average output power capability		-	3.0W	-	CC mode load: 4.0mA~125mA (0.1W~3W).
Pulsed output power capability		-	6.0W	-	Dynamic CC mode load: peak load = 250mA/2.2ms and avg load = 4.0mA~125mA/3.8ms.
Start-up time		-	-	0.6s	From AC power on to V _{aux} increases and reaches 21.6 V, Mains applied at any phase angle.
Integrated DALI Bus Power Supply					
DALI Bus voltage		12V	16V	22.5V	CC load: 0~50mA, DALI-2 bus power is disabled(OFF) by default, and it can be enabled via GUI.
Over Current Protection		50mA	-	62.5mA	Auto recovery and no component damaged. Limits output current to 50~62.5mA when output is short-circuited.

LED Driver

LNA ARENA SPORT 1.6KW Series

Dimming Control

Specification		Test Conditions / Notes
Control interface		DALI-2 & D4i RDM/DMX
Dimming range	Logarithmic	0.1%-100% (2mA-2000mA, DALI default dimming mode)
	Linear	0.4%-100% (8mA-2000mA, DMX default dimming mode)

Control Interface Standards

Specification	Standards
DALI Control interface standards	DALI-2 & D4i IEC 62386-101 Ed 2.0 IEC 62386-102 Ed 2.0 IEC 62386-207 Ed 2.0 IEC 62386 part 150: Integrated 24Vdc auxiliary power supply IEC 62386 part 250: Integrated bus power supply for sensor and radios IEC 62386 part 251: Memory bank 1 extension (luminaire data) IEC 62386 part 252: Energy report IEC 62386 part 253: Diagnostics and maintenance
RDM/DMX Control interface standards	DMX & RDM ANSI E1.11 DMX512A ANSI E1.20 RDM – Remote Device Management ANSI E1.37-1 Additional message sets for dimmer

Additional Dimming Features

Specification	Description
Smart Timer Dimming (STD)	3 different configurable dimming profiles over the night are available for users to select and set in GUI. More details please refer to " LNA/EUCO Series Programming Tool User Manual ".
Constant Lumen Output (CLO)	CLO function is to compensate the aging of the light source, resulting in a constant lumen output over the lifetime of the driver. It's available in GUI for the relevant configuration. For more information, please refer to " LNA/EUCO Series Programming Tool User Manual ".

Mechanical Characteristics

Specification		Test Conditions / Notes
Housing		Aluminum case, dark gray, compliance with C5 environment (ISO 9223)
Dimensions (L x W x H)		500x152x77 mm
Unit Weight		~5.6 kg
Cooling System		Natural Convection
Input		L1, L2, PE
Output ⁵	LED Load	PE, NTC, V3+ V3-, V2+, V2-, V1+, V1-
	DALI	DA+, DA-, +24V ("DA-" is the ground of "+24V")
Control	RDM/DMX	D1+, D1-, COM

5. This is a common "Output +" design which shares equal connections between V1+, V2+ and V3+.

LED Driver

LNA ARENA SPORT 1.6KW Series

Environment & Package

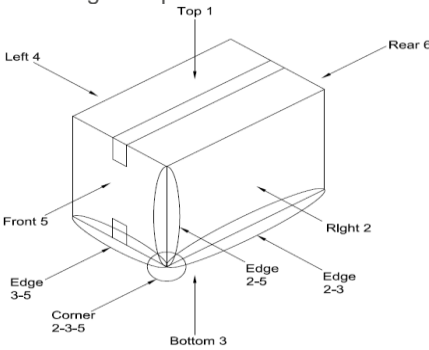
Specification		Test Conditions / Notes
Ambient Temperature	Operating	-40 ~+50°C
	Storage	-40°C to +85°C
Maximum Case Temperature		+85°C
Lifetime Case Temperature		+80°C
Relative Humidity	Operating	10% to 90% RH (Non-Condensing)
	Storage	10% to 90% RH (Non-Condensing)
Audible Noise (30cm distance)		Sound Pressure Level (SPL) < 24dBA
Ingress Protection classification		IP66 (EN 60529)
Impact Protection classification		IK08 (EN 62262)
Drop Test (Non-Operating)		<p>According to ASTM D-775, 40cm height drop to concrete floor as below drawing, total 10 times.</p> 
Vibration (Non-Operating)		IEC 60068-2-6, Random: 5 Hz to 10 Hz (1G); 30 min per axis for all X, Y, Z direction
Packing		1pcs per carton

Protections

Specification		Min.	Typ.	Max.	Test Conditions / Notes
Input Under Voltage Protection(IUVP)	Protection	165Vac	170 Vac	175 Vac	Shuts down and then restarts to normal status when the fault condition is cleared.
	Recovery	175 Vac	180 Vac	185 Vac	
Input Over Voltage Protection(IOVP)	Protection	540 Vac	545 Vac	550 Vac	
	Recovery	530 Vac	535 Vac	540 Vac	
Open Load / Output Over Voltage Protection	Protection	-	-	600Vrms	Hiccup mode. The output voltage shall not exceed 600Vrms under no load, open load or other over voltage conditions.
Constant Power Output Protection		600 W	610 W	620 W	Output power limited. The driver shall come back to its original programmed current after the fault condition is cleared.
Output Short Circuit Protection		YES			Hiccup mode. Restarts automatically after fault condition is removed.
Internal Over Temperature Protection		YES			Driver OTP, decrease the output current to 20%*Io when Tc ≥ 90 ± 5°C, auto recovery when Tc ≤ 80 ± 5°C
Programmable External Over Temperature Protection		YES			Luminaire OTP, output power derating. Refer to Appendix 7 "Programmable External Over Temperature Protection" for more details.

LED Driver

LNA ARENA SPORT 1.6KW Series

Electro-Magnetic Compatibility (EMC)

Specification	Standards
EMC-Emission Characteristics	
Radiated Emission	EN55015, GB/T17743, FCC Part 15 Subpart B
Conducted Emission	EN55015, GB/T17743, FCC Part 15 Subpart B
Harmonic Current Emission	IEC 61000-3-2, GB 17625.1
Voltage Fluctuation & Flicker	IEC 61000-3-3
EMC-Immunity Characteristics	
Electrostatic Discharge (ESD)	IEC 61000-4-2
Radio Frequency Electro-magnetic Fields	IEC 61000-4-3
Electrical Fast Transient (EFT)	IEC 61000-4-4
Surge (AC Mains) ⁶	IEC 61000-4-5 - Common Mode: 10kV (L1 to Earth, L2 to Earth) - Differential Mode: 10kV (L1 to L2)
Surge (Output)	IEC 61000-4-5 - Common Mode: 3kV (V1+/V2+/V3+ to Earth, V1-/V2-/V3- to Earth) - Differential Mode: 1kV (V1+ to V1- / V2+ to V2- / V3+ to V3-)
Surge (Dimming)	IEC 61000-4-5 - Common Mode: 3kV (DA+ to Earth, DA- to Earth) - Common Mode: 3kV (D1+ to Earth, D1- to Earth, COM to Earth,) - Differential Mode: 1kV (DA+ to DA-) - Differential Mode: 1kV (D1+ to D1-, D1+ to Com, D1- to Com)
Surge (NTC)	IEC 61000-4-5 - Common Mode: 3kV (NTC to Earth) - Differential Mode: 1kV (NTC to V1+/V2+/V3+)
Conducted Disturbance	EN61000-4-6
Voltage Dip & Interruptions	EN 61000-4-11

6. Level B, the peak of residual common mode voltage pulse from output +/- to Earth is around 2.5kV.

Reliability Data

Specification	Test Conditions / Notes
Lifetime	50,000 hours applicable for 220Vac to 480Vac(50/60Hz)@100% of load, Ta=45°C (Tcase=80°C), 100,000 hours applicable @ 100% of load, Tcase≤70°C. Refer to Appendix 3 "Life Time versus Case Temperature Curve" for more details.
MTBF	475khrs. at Ta=+45°C Telcordia SR-332
Warranty	5 years, refer to Appendix 8 "Warranty Policy" for more details.

LED Driver

LNA ARENA SPORT 1.6KW Series

Safety & Other Approvals ⁷

Safety Category		Standards
ENEC	MARK	EN 61347-1:2015, EN 61347-1:2015/A1:2021 EN 61347-2-13:2014, EN 61347-2-13/A1:2017 EN IEC 62384:2020
CB	REPORT	EN 61347-1:2015, EN 61347-1:2015/A1:2021 EN 61347-2-13:2014, EN 61347-2-13/A1:2017
UKCA	MARK	BS EN 61347-2-13: 2014+A1:2017
CE	MARK	CE Declaration of Conformity.
UL	MARK	UL Compliant ANSI / UL8750 2 nd Ed. CSA C22.2 No.250.13, 4 th Ed.
RCM	MARK	AS/NZS 61347-1: 2016+A1 AS 61347-2-13: 2018
CCC	MARK	GB 19510.1 GB 19510.14
BIS	MARK	IS 15885(Part 2/Sec 13)
KC	Compliant with	K 61347-1 K 61347-2-13
PSE	Compliant with	J 61347-1 J 61347-2-13
Isolation		Class I, input to output: non-isolation, RDM/DMX and DALI to input/output reinforced isolation.
RoHS		RoHS 2.0 Directive(EU) 2015/863
REACH		In compliance

7. If you have any requirements for safety approvals, please contact us.

Drivers for each circuit breaker

The maximum number of LED drivers connectable to a single MCB is recommended in the following table for maximum 1650W and each nominal input voltage. Due to the different kinds of circuit breakers available on the market, this table is just for reference.

Input Voltage	MCB Type	16A	20A	25A	32A	40A	63A
208 Vac	B/C	1	1	2	3	3	6
220 Vac	B/C	1	2	2	3	4	6
277 Vac	B/C	2	2	3	4	5	8
400 Vac	B/C	2	3	4	5	7	11
480 Vac	B/C	3	4	5	7	8	13

LED Driver

LNA ARENA SPORT 1.6KW Series

Electrical Connection

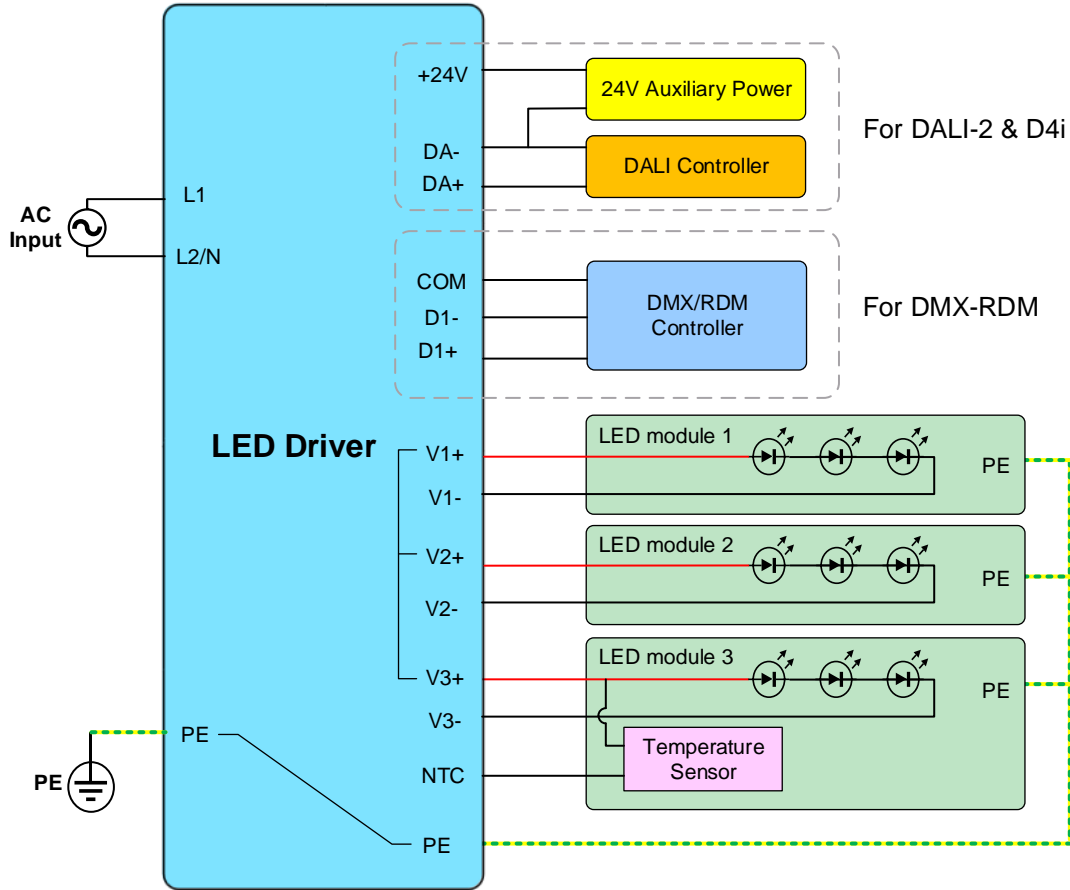

Note:

- a) This is a common “OUTPUT +” design that V1+, V2+ and V3+ are electrically connected together internally and have exactly equal outputs, but V1-, V2-, and V3- should not be connected together during installation.
- b) Simply connect the controller to the appropriate terminals to fulfill the control requirements without additional configuration.
- c) The maximum permissible voltage on the control interface terminals should not exceed 60Vrms, otherwise damage may occur and reliability may be compromised.

LED Driver

LNA ARENA SPORT 1.6KW Series

Programming Configuration

1. LNA/EUCO Series Programming Tool

Common setting functions and implementation methods/conditions are shown in the following table, more functions and details please refer to the **LNA/EUCO Series Programming Tool User Manual**.

Item		DALI	DMX
Setup	Tool Connection	DA+,DA-	D1+,D1-
	AC power supply	■	■
	Load Connection	○	○
Tool	Delta Programming Tool	SDDV1505UAC (SDDV1505UAB, SDPTDV05UAB)	
Configurable Parameters and Functions	Max. current programming	√	√
	Default output current	√	√
	Luminaire OTP setting	√	√
	Constant lumen output setting	√	√
	Smart timer dimming	√	√
	Address mode	√	√
	Software update	√	√

Note: ■ Required, ○ Optional, √ Available.

2. DALI & RDM Standard Controller

This driver is compatible with D4i and RDM functions, providing a variety of free configuration options and rich monitoring data, such as personalized assignment of addresses, access to output status information. Customers can configure it flexibly according to their own usage requirements. Please refer to the “**D4i & RDM Data Management User Manual**” for the relevant configuration instructions.

Physical Dimensions

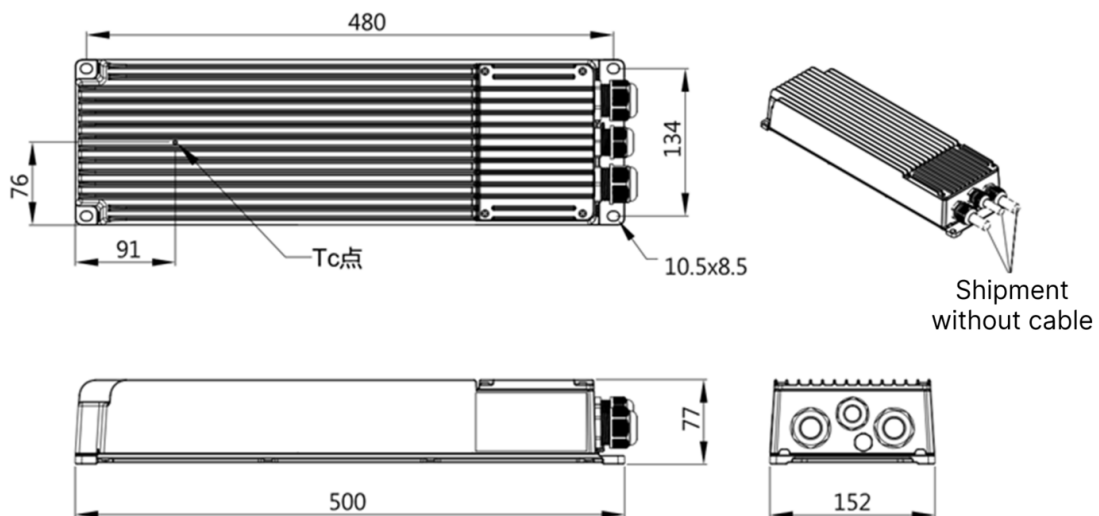

Unit: mm

LED Driver

LNA ARENA SPORT 1.6KW Series

Cable Gland

M25 cable gland to housing: 3.43Nm

M20 cable gland to housing: 3.43Nm

Vent to housing: 0.6~0.8 Nm

 Do not loosen the Protective Vent

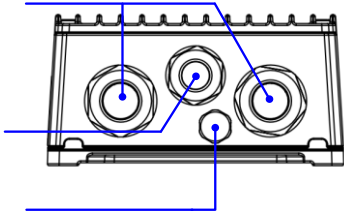

Input: M25 cable gland (5 Nm)
Clamping cable: 10.0~16.3mm
1.0~2.5□ AWG 17~12

Control: M20 cable gland

- Plug by default (1 Nm)
- Clamping cable (3.5 Nm):
 - a) 6.3~11.3mm(1 hole seal)
 - b) 5.0~6.5mm(2 holes seal)

0.3~2.5□ AWG 22~12

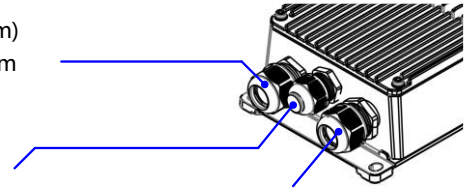

Output: M25 cable gland (5 Nm)
Clamping cable:

- a) 10.0~16.3mm(1 hole seal)
- b) 5.0~6.5mm(2/3 holes seal)

 0.75~2.5□ AWG 18~12

Note: More details about cable selection information, please refer to the **Installation User Manual**.

Junction Box

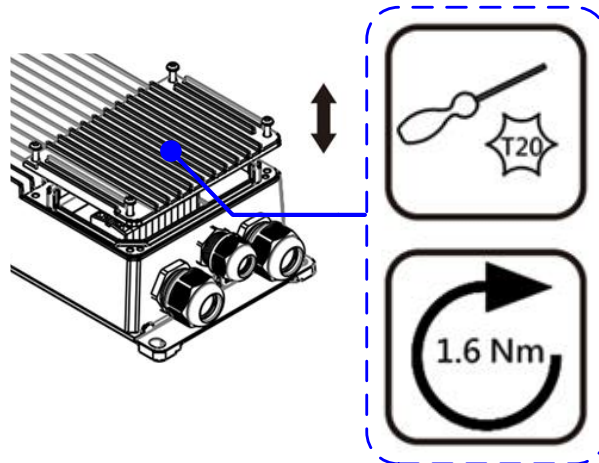

Note: The cap and fastening 4 screws all have the function of anti-falling off.

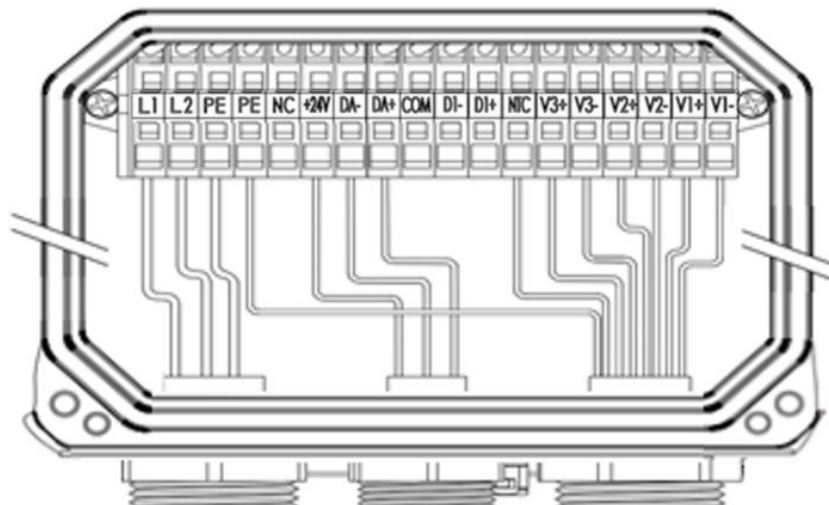

DALI Connection

LED Driver

LNA ARENA SPORT 1.6KW Series

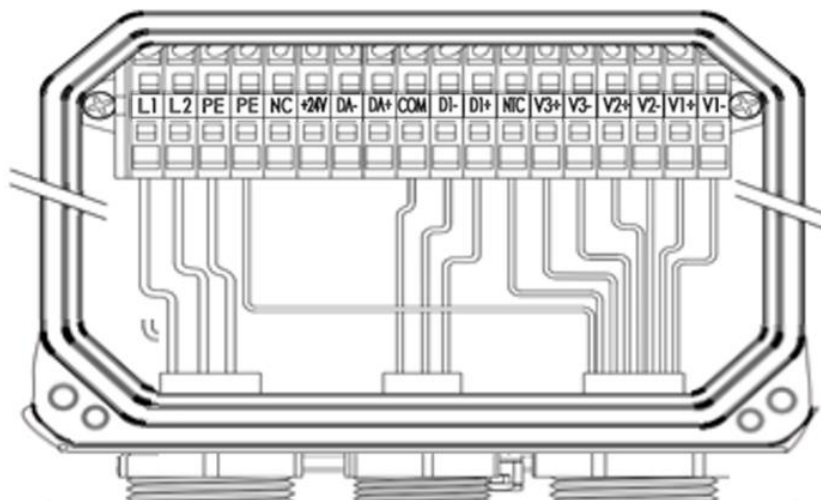

RDM/DMX Connection

Number	Label	Description
1	L1	AC input
2	L2	AC input
3	PE	Protective Earth
4	PE	Protective Earth for luminaire
5	NC	Reserved
6	+24V	+24V/3W auxiliary power supply, and the ground of "+24V" is "DA-".
7	DA-	DALI input -, and the ground of "+24V"
8	DA+	DALI input +
9	COM	DMX Common port/Shielding
10	D1-	DMX input -
11	D1+	DMX input +
12	NTC	Luminaire Temperature Detection
13	V3+	Channel 3 output +
14	V3-	Channel 3 output -
15	V2+	Channel 2 output +
16	V2-	Channel 2 output -
17	V1+	Channel 1 output +
18	V1-	Channel 1 output -

LED Driver

LNA ARENA SPORT 1.6KW Series

Appendix

1. Operating Range

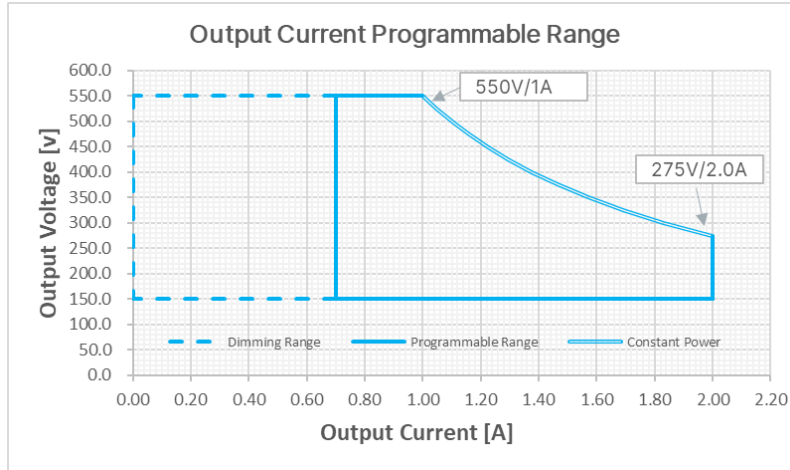

Note: LNA-1K6C20ABFGB series can be programmed with wide output current through computer and programming tool. For more details, please refer to **LNA/EUCO Series Programming Tool User Manual**.

2. Dimming Curve

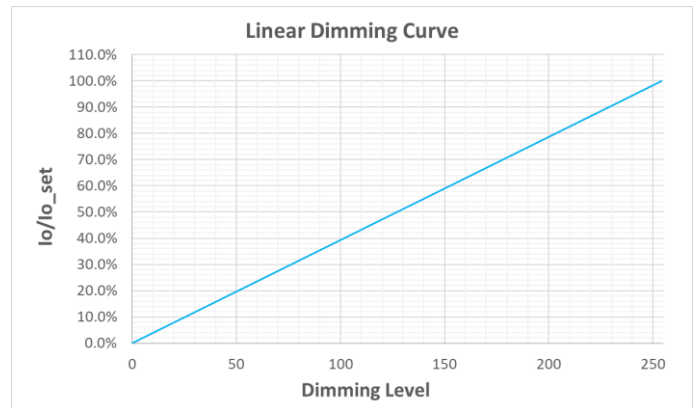
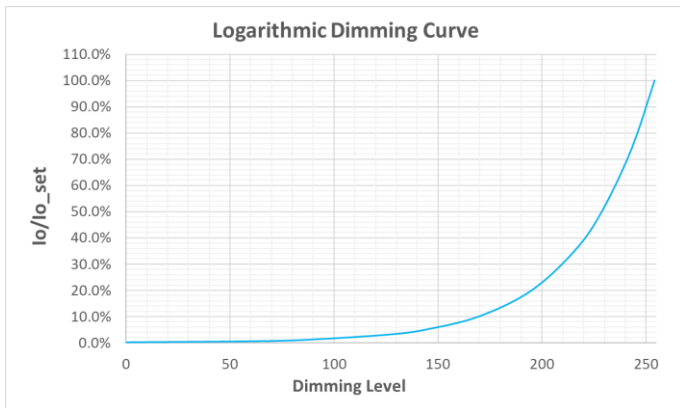

DALI/DMX

3. Life Time versus Case Temperature Curve

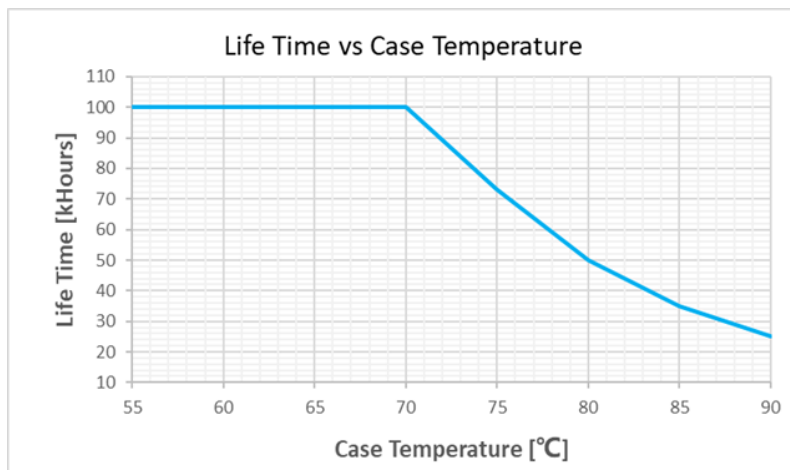

LED Driver

LNA ARENA SPORT 1.6KW Series

4. Efficiency versus Load

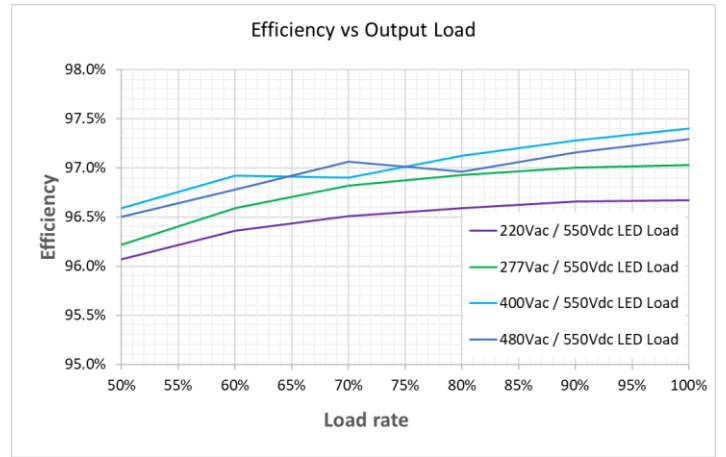
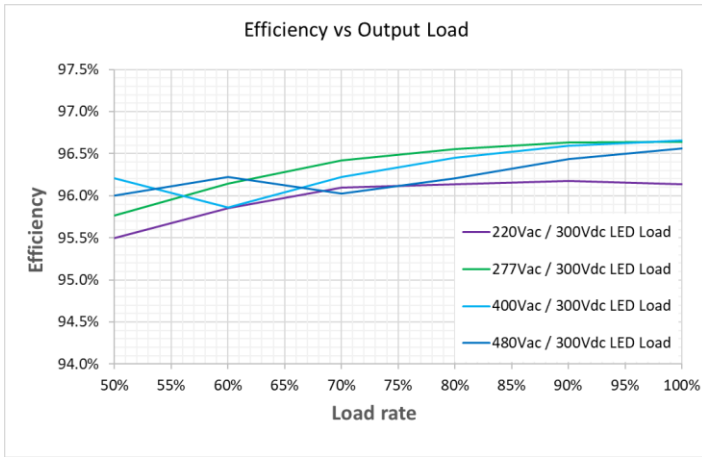

5. Power Factor versus Load

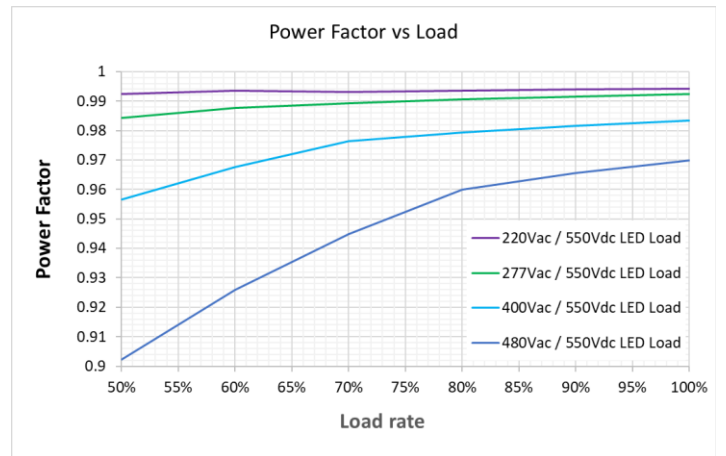
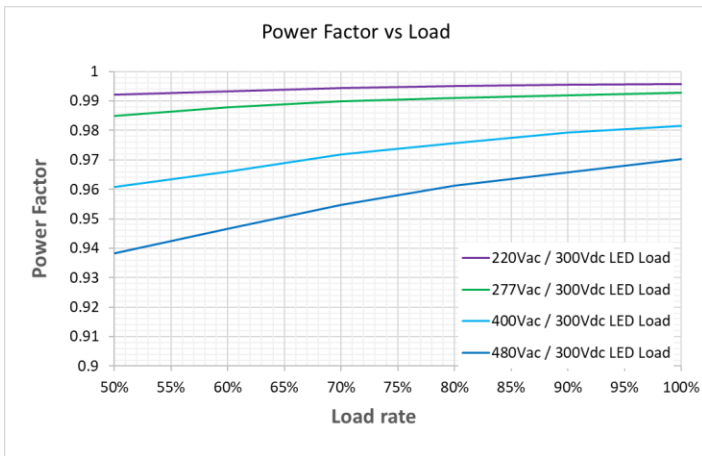

6. THD versus Load

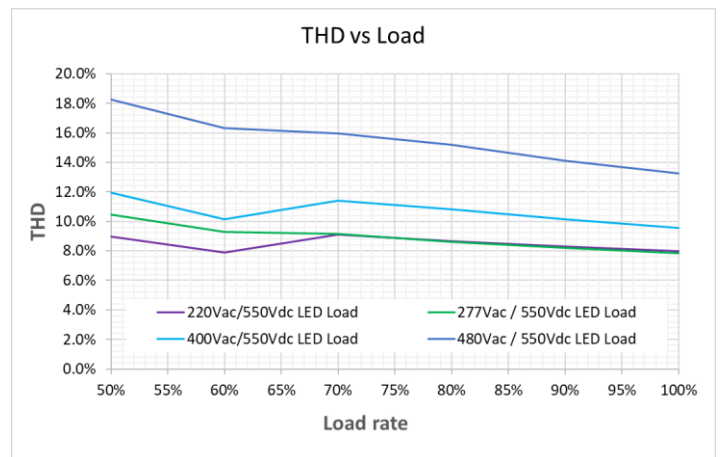
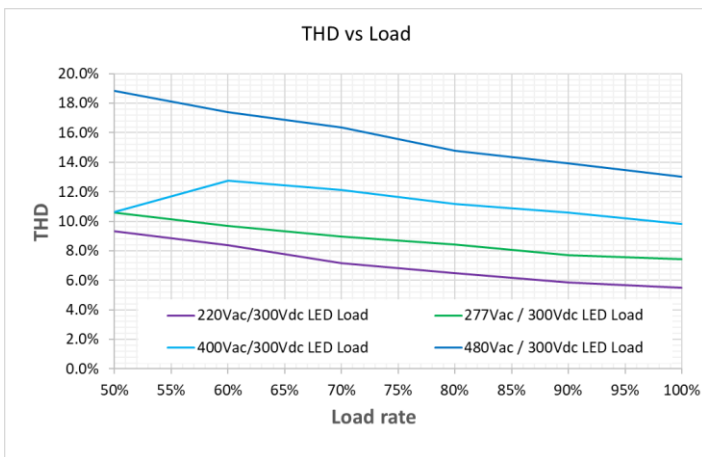

LED Driver

LNA ARENA SPORT 1.6KW Series

7. Programmable External Over Temperature Protection

This protection is an optional feature and user can ignore it without connecting to NTC connector in the junction box. The driver monitors the temperature of the LED module through NTC terminal. The output current will be reduced smoothly and linearly at OTP status and return to normal when the fault condition is removed.

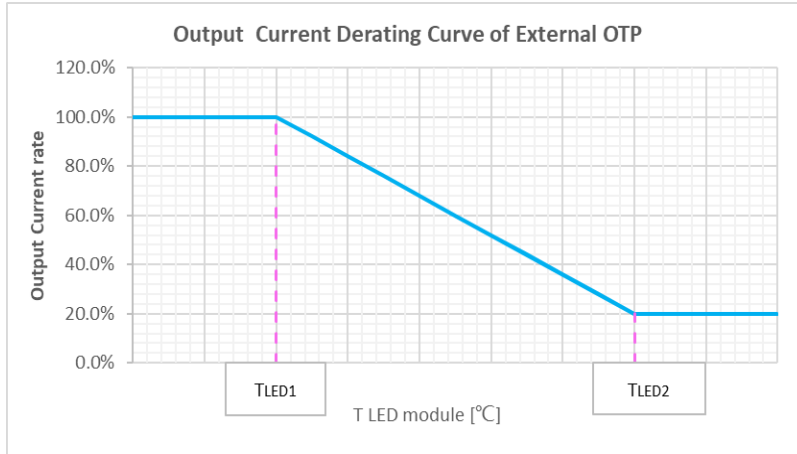

The trigger point of this protection can be set easily according to the actual conditions of the LED fixtures, the user can set the trigger point between 80°C and 110°C by the Delta programming tool, and the default value is 110°C. When the temperature exceeds the triggering point, the output current will decrease automatically to bring the temperature of the LED module back to safe value. More details about parameter setting please refer to **LNA/EUCO Series Programming Tool User Manual**. An external temperature sensing circuit is required to achieve the NTC terminal function to prevent the LED fixture from overheating. The default setting is for a 33Kohm NTC, the circuits shown as both (a) and (b) below are acceptable.

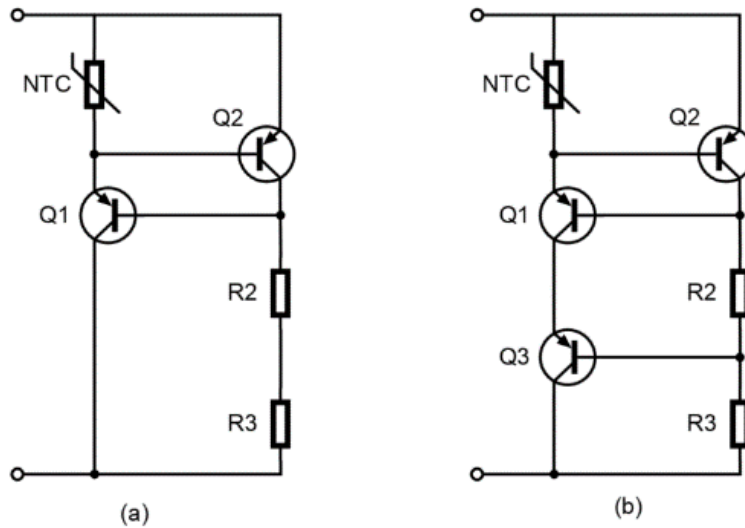

The circuits (a) and (b) have same OTP performance by using the same parts listed in the table, and to achieve good accuracy of OTP, Q2 should be placed close to NTC to make them have same temperature.

Parameter	Part	Manufacturer	Description
NTC	TSM1A333F3952RZA	THINKING	RES NTC 33Kohm F 3950K +/-1% SMD 0603 TP
R2 / R3	RC1206FR-07 5M1L	YAGEO	RES SMD 1/4W 5.1Mohm F 1206
Q1 / Q2 / Q3	PBHV9050T	NEXPERIA	-500V -250 mA PNP high-voltage low VCEsat transistor

This product is also compatible with the circuitry (b) for a 10Kohm NTC, this version could be selected and activated by “OTP on Fixture” section of GUI (Select “10K” in this section). The circuit and BOM table are shown as below.

LED Driver

LNA ARENA SPORT 1.6KW Series

Parameter	Part	Manufacturer	Description
NTC	NTCG163JH103JT1	TDK	RES NTC 10Kohm F 3380K +/-1% SMD 0603
R2/R3	RC1206FR-07 1ML	YAGEO	RES SMD 1/4W 1Mohm F 1206
Q1/Q2/Q3	PBHV9050T	NEXPERIA	500V 150 mA PNP high-voltage low VCEsat transistor

Note:

- The recommended temperature detection circuit should be on the LED module.
- NTC should be placed as close to Q2 as possible.
- Do not make any change to the temperature detection circuit of LED module.
- The specifications of alternative components should be the same as the recommended sources. Especially, the NTC is a key and thermos-sensitive component and DO NOT change to other types, like B value = 4480K.

8. Warranty Policy

Please reach out our [Warranty Policy](#) should you require any further clarification.

9. Attention

Delta provides all information in the datasheets on an "AS IS" basis and does not offer any kind of warranty through the information for using the product. In the event of any discrepancy between the information in the catalog and datasheets, the datasheets shall prevail (please refer to <http://www.DeltaPSU.com> for the latest datasheets information). Delta shall have no liability of indemnification for any claim or action arising from any error for the provided information in the datasheets. Customer shall take its responsibility for evaluation of using the product before placing an order with Delta.

Delta reserves the right to make changes to the information described in the datasheets without notice.