

# Medical AC-DC Open Frame Power Supply

## 24 V 400 W 3.5" x 5.5" High Density MDS-400APB24

# MDS-400APB24

### Highlights & Features

- Safety Approvals to IEC 60601-1 & IEC 62368-1
- Compliant with IEC 60601-1-2 Ed. 4 Requirements
- Up to 200 W convection, 400 W force air
- IT & Medical Safety Approvals

### Safety Standards



CB Certified for worldwide use



<b>Model Number:</b>	MDS-400APB24
<b>Unit Weight:</b>	405 g (0.89 lb)
<b>Dimensions (L x W x H):</b>	127.3 x 76.5 x 36.1 mm (5 x 3 x 1.4 inch)

### General Description

The MDS-400APB24 of internal open frame power supplies come with universal AC input range from 90 Vac to 264 Vac. Other features include low leakage, Type BF Patient Access Leakage Currents, and electric shock protection compliance with 2 x MOPP requirements. The MDS series is certified for EMC standards according to EN/BS EN 55011 for industrial, scientific and medical (ISM) radio-frequency equipment; and, EN/BS EN 55032 for Industrial Technology Equipment (ITE) radio-frequency equipment.

The MDS-400A series comes with both medical and ITE safety approvals, including UL/CE, and CB certification. Designs are compliant with RoHS Directive for environmental protection.

### Model Information

#### Medical AC-DC Open Frame

Model Number	Main Output Voltage	Main Output Current	Standby Output Voltage	Standby Output Current	Fan Output Voltage	Fan Output Current	Total Max Output Power
MDS-400APB24	24 Vdc	0-16.66 A	5 Vdc	0-2 A	12 Vdc	0.05-0.6 A <sup>1)</sup>	400 W <sup>2)</sup>

1) Fan output will be presenting when 24V main output is available  
 2) With 10CFM force air

### Model Numbering

MDS	-	400	A	P	B	24	□	□□
Delta Medical Power Supply		Max wattage in the product series. 400 → 400 W	Family Code A - Z	Product Type P: Open Frame	Input Type Code B: 3pin Class I	Output Voltage 24 for 24 V	Blank	AA: With Remote On/Off AB: Without Remote On/Off  Refer to page 8

# Medical AC-DC Open Frame Power Supply

## 24 V 400 W 3.5" x 5.5" High Density MDS-400APB24

### Specifications

#### Input Ratings / Characteristics

Nominal Input Voltage	100-240 Vac
Input Voltage Range	90-264 Vac
Nominal Input Frequency	50-60 Hz
Input Frequency Range	47-63 Hz
Input Current (max)	5.5 A
Input Surge Voltage (max)	300 Vac for 100 ms
Full load Efficiency (typ.)	92% @ 115 Vac/60 Hz 93% @ 230 Vac/50 Hz, Reference Fig. 1
Standby Power (max)	0.5 W (only standby working with Inhibit signal high) @ 115 Vac/60 Hz, 230 Vac/50 Hz
Inrush Current (max)	40 A @ 230 Vac, cold start
Input-PE (protective earth) leakage current(max)	0.1 mA @ NC, 0.3 mA @ SFC1)
Output-PE (protective earth) leakage current for Type BF application (max)	0.1 mA @ NC, 0.5 mA @ SFC 1)
Power Factor (min)	0.95 @ 115 V/50 Hz, 230 V/50 Hz, full load

1) NC: normal condition, SFC: single fault condition

#### Leakage Current

Input-PE Leakage Current	100 Vac/60 Hz (typ)	264 Vac/60 Hz (typ)	Delta Limit	IEC 60601-1 Limit
Normal Condition	18.3 uA	44.6 uA	100 uA max	5000 uA max
Single Fault Condition	33.7 uA	91.9 uA	300 uA max	10000 uA max
Output-PE Leakage Current for Type BF application				
Normal Condition	29.4 uA	87.3 uA	100 uA max	100 uA max
Single Fault Condition	43.5 uA	130.5 uA	500 uA max	500 uA max

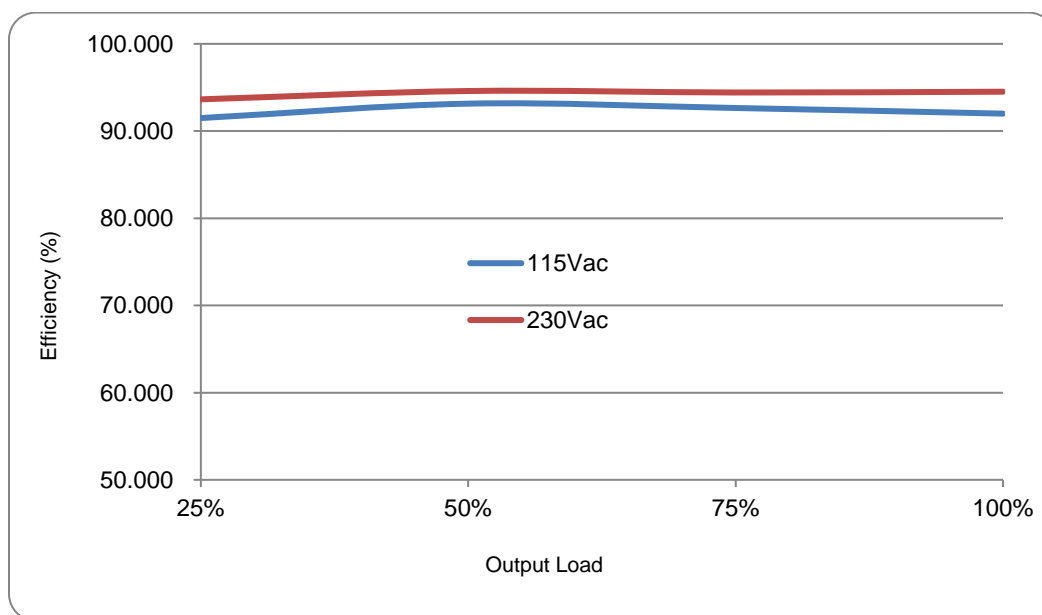

Fig. 1 Efficiency versus output load

# Medical AC-DC Open Frame Power Supply

## 24 V 400 W 3.5" x 5.5" High Density MDS-400APB24

### Output Ratings / Characteristics

Nominal Output Voltage (Vrated)	24 V
Output Voltage Tolerance	±3%
Output Power	400 W max with 12 CFM air cooling
Line Regulation (max)	±0.5%
Load Regulation (max)	±1%
Ripple & Noise (typ.)	1%pk-pkVrated@ Full load, Reference Fig. 2
Start-up Time(max)	2000 ms @115 Vac
Hold-up Time (min)	10 ms @ 115 Vac, with 400 W load
Dynamic Response (Overshoot & Undershoot O/P Voltage)	±5% @ 50-100% load
Capacitive load (max)	1500 uF
Rise time (max)	100 ms
Remote Sense	Compensate up to 500 mV lead drop with remote sense Short and reverse connection protected. PSU can work normally with remote sense pins left open.

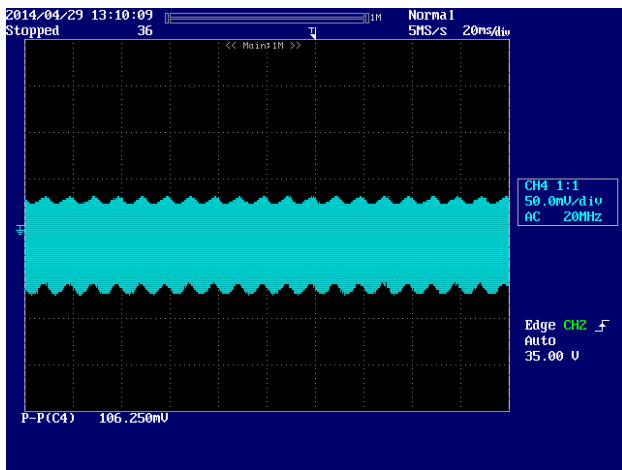

(a) 115 V (measured value=106 mV)

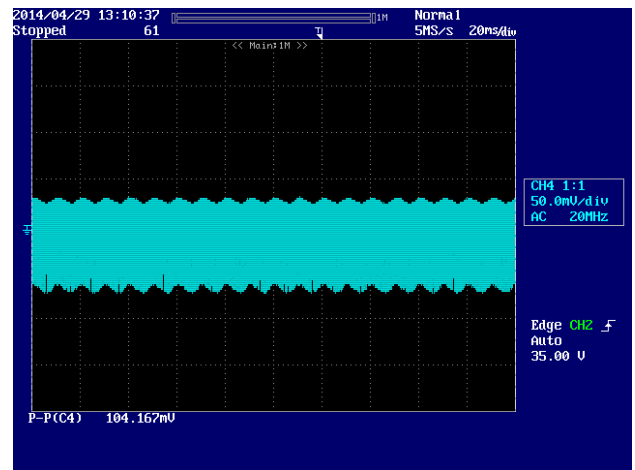

(b) 230 V (measured value=104 mV)

Fig. 2 Ripple & Noise example, 20 MHz BW

### Output Ratings / Characteristics—Standby Output

Nominal Output Voltage of standby output (Vrated)	5 V
Total Regulation of standby output	±3%
Ripple & Noise of standby output	100 mV max (Refer to Fig. 3)

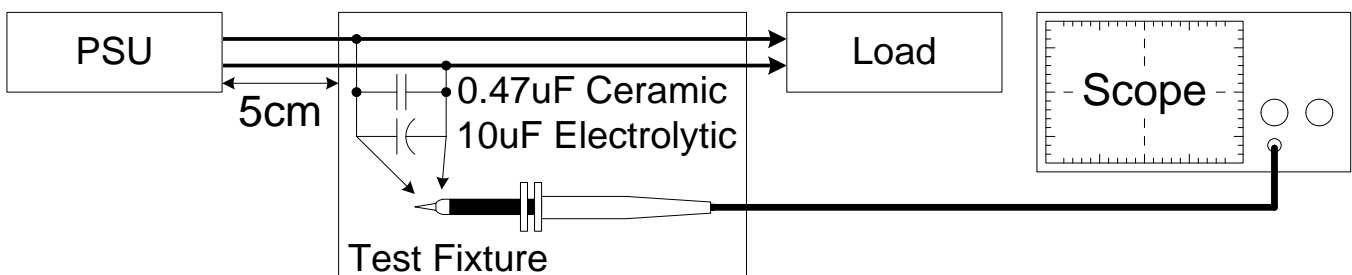

Fig. 3 Ripple & Noise measurement circuit

# Medical AC-DC Open Frame Power Supply

## 24 V 400 W 3.5" x 5.5" High Density MDS-400APB24

### Mechanical

Case Cover	NA
Dimensions (L x W x H)	127.3 x 76.5 x 36.1 mm (5 x 3 x 1.4 inch)
Unit Weight	405 g (0.89 lb)
Indicator	NA
Cooling System	NA

### Environment

Surrounding Air Temperature	Operating	Absolute Max -10°C to+70°C, supported power linearly de-rate from 50°C to 50% rated up to 70°C for forced air. Convection power de-rate from 200 W @ 40°C to 100 W @ 60°C Note: see power de-rating curve
	Storage	-40°C to+85°C
Operating Humidity	5-95% RH (Non-Condensing)	
Operating Altitude	5,000 meters (16,400 feet or 50 kPa)	
Non-operating Altitude	5,000 meters (16,400 feet or 50 kPa)	
Shock Test (Non-Operating)	50 G, 11 ms, 3 shocks for each direction	
Vibration (Operating)	5-500 Hz, 2 Grms, 15 minute for each three axis	

### Power De-rating curve

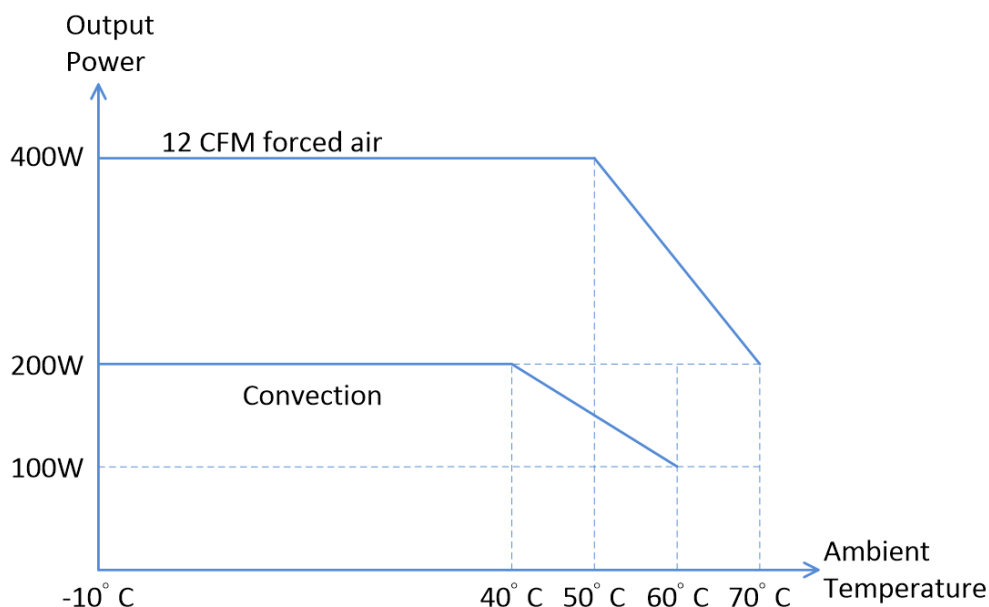

# Medical AC-DC Open Frame Power Supply

## 24 V 400 W 3.5" x 5.5" High Density MDS-400APB24

Thermal Fixture Setup. With Fan P/N: DELTA AFB0512HHD

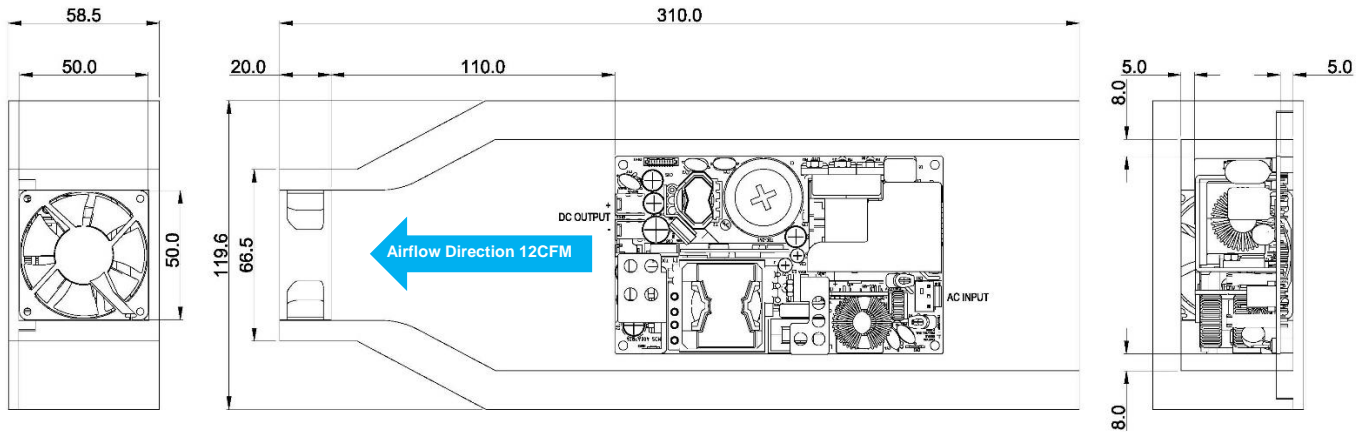

### Protections

Overvoltage (max)	135% of rated voltage, Latch Mode
Overload / Overcurrent (max)	Main output 160% of rated current Standby 3 A max Hiccup Mode (Non-Latching, Auto-Recovery)
Over Temperature	Latch Mode
Short Circuit	Hiccup Mode (Non-Latching, Auto-Recovery)

### Reliability

MTBF (Minimum) at 100 Vac, 400 W, ambient 25 °C	500 kHrs based on Telecordia SR-332
Operating life at 115 Vac, 400 W, ambient 25 °C,	26,280 Hrs

# Medical AC-DC Open Frame Power Supply

## 24 V 400 W 3.5" x 5.5" High Density MDS-400APB24

### Safety Standards / Directives

Medical Safety	IEC 60601-1 CB report TUV EN 60601-1 UL 60601-1+CAN/CSA 60601-1						
ITE Safety	IEC 60950-1 CB report IEC 62368-1 TUV 60950-1 UL 60950-1+CAN/CSA 60950-1						
CE	In conformance with EMC Directive 2014/30/EU and Low Voltage Directive 2014/35/EU  EN 60601-1: 2006 + A11: 2011 + A1L 2013 + A12: 2014 & EN 60601-1-2: 2015						
UKCA	In conformance with Electrical Equipment (Safety) Regulations 2016 and Electromagnetic Compatibility Regulations 2016, Medical Devices Regulations 2002 (UK MDR 2002)						
Galvanic Isolation	<table border="1"> <tr> <td>Input to/Output (2xMOPP)</td> <td>4000 Vac</td> </tr> <tr> <td>Input to/Ground (1xMOPP)</td> <td>1500 Vac<sup>1)</sup></td> </tr> <tr> <td>Output to/Ground (1xMOPP)</td> <td>1500 Vac (Type BF application rated)</td> </tr> </table>	Input to/Output (2xMOPP)	4000 Vac	Input to/Ground (1xMOPP)	1500 Vac <sup>1)</sup>	Output to/Ground (1xMOPP)	1500 Vac (Type BF application rated)
Input to/Output (2xMOPP)	4000 Vac						
Input to/Ground (1xMOPP)	1500 Vac <sup>1)</sup>						
Output to/Ground (1xMOPP)	1500 Vac (Type BF application rated)						

1) PSU can support PoE applications with Primary to FG 2500 Vac test.

# Medical AC-DC Open Frame Power Supply

## 24 V 400 W 3.5" x 5.5" High Density MDS-400APB24

### EMC (Compliant with IEC 60601-1-2 4th Ed. Requirements)

EMC / Emissions		EN/BS EN 55011 & compliant with EN/BS EN 55032, FCC Title 47: Class B
Harmonic Current Emissions	IEC61000-3-2	Meet Class D limit
Voltage Flicker	IEC61000-3-3	
Immunity to		
Electrostatic Discharge	IEC61000-4-2	Level 4 Criteria A <sup>1)</sup> Air Discharge: 15 kV Contact Discharge: 8 kV
Radiated Field	IEC61000-4-3	Criteria A <sup>1)</sup> 80 MHz-2700 MHz, 10 V/m AM modulation 385 MHz-5785 MHz, 28 V/m Pulse mode and other modulation
Electrical Fast Transient / Burst	IEC61000-4-4	Level 3 Criteria A <sup>1)</sup> : 2 kV
Surge	IEC61000-4-5	Level 3 Criteria A <sup>1)</sup> Common Mode <sup>3)</sup> : 2 kV Differential Mode <sup>4)</sup> : 1 kV
Conducted	IEC61000-4-6	Level 2 Criteria A <sup>1)</sup> 150 kHz-80 MHz, 3 Vrms, 6 Vrms at ISM bands and Amateur radio bands
Power Frequency Magnetic Fields	IEC61000-4-8	Criteria A <sup>1)</sup> Magnetic field strength 30 A/m
Voltage Dips	IEC61000-4-11	Criteria A <sup>1)</sup> 0% U <sub>T</sub> , 0.5 cycle (10 ms), 0°/45°/90°/135°/180°/225°/270°/315°/360°  Criteria B <sup>2)</sup> 0% U <sub>T</sub> , 1 cycle (20 ms), 0°  Criteria B <sup>2)</sup> 70% U <sub>T</sub> , 25 cycle (500 ms), 0°  Criteria B <sup>2)</sup> 0% U <sub>T</sub> , 250 cycle (5000 ms), 0°

1) Criteria A: Normal performance within the specification limits

2) Criteria B: Output out of regulation, or shuts down during test. Automatically restore to normal operation after test.

3) Asymmetrical: Common mode (Line to earth)

4) Symmetrical: Differential mode (Line to line)

# Medical AC-DC Open Frame Power Supply

## 24 V 400 W 3.5" x 5.5" High Density MDS-400APB24

### Dimensions

L x W x H: 127.3 x 76.5 x 36.1 mm

Mechanical drawing (3Pin input type)

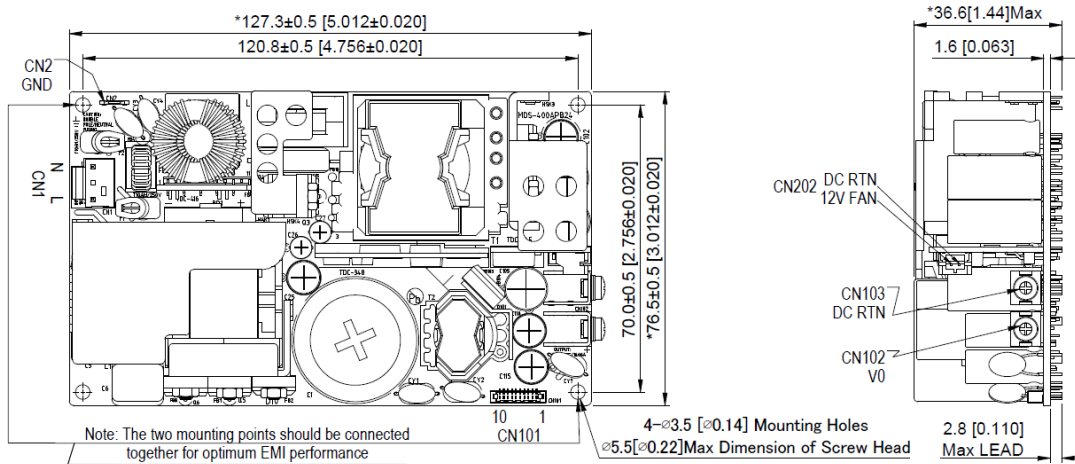

### Notes

- Dimensions are in mm (inches)
- CN1 mates with Molex housing 26-03-4030 and Molex series 6838 crimp terminals. Input Line can also be connected to Input Neutral, and Input Neutral can be connected to Input Line.
- CN102 & CN103(Output Connector): Cross recessed pan head screws M3X0.5x10, with spring washers and flat washers, force required to tighten the screws is 7~8kgf.cm(6.1~7.0inch-lb)
- CN2: PINGOOD JP-13T or equivalent mates with KST:FDNYD1-187 or other applicable connectors.
- CN202 mates with JST housing PHR-2 and JST SPH-002T-P0.5S terminals.
- CN101 mates with JST housing SHR-10V-S-B & SHR-10V-S and JST SSH-003T-P0.2-H crimp terminals.

Control and STANDBY connector CN101	
Pin 1	Remote sense +
Pin 2	Remote sense -
Pin 3	Power Good +
Pin 4	Power Good -(DC RTN)
Pin 5	Remote ON_OFF/INHIBIT +
Pin 6	Remote ON_OFF/INHIBIT -(DC RTN)
Pin 7	5 V Standby
Pin 8	DC RTN
Pin 9	5 V Standby
Pin 10	DC RTN

Two mounting points in mechanical drawing need to be connected to system earth case together, Protective bonding conductor from the end product protective earth terminal (if any) can be tied to CN2 for open frame model.

MDS-400APB24 □□	
<u>AA</u>	Delta Standard
<u>AB</u>	A mating connector with JST housing SHR-10V-S-B & SHR-10V-S and JST SSH-003T-P0.2-H terminals, with jumper wire between pins 5 and 6, will be inserted into CN101. This will allow the power supply to turn on, without user intervention, upon the application of input AC voltage Due to presence of mating connector, external connections cannot be made to pins 1-10 of CN101.



# Medical AC-DC Open Frame Power Supply

## 24 V 400 W 3.5" x 5.5" High Density MDS-400APB24

### Functions

#### Start-up Time

The time required for the output voltage to reach 90% of its set value, after the input voltage is applied.

#### Rise Time

The time required for the output voltage to change from 10% to 90% of its set value.

#### Hold-up Time

Hold up time is the time when the AC input collapses and output voltage retains regulation for a certain period of time. The time required for the output to reach 90% of its set value, after the input voltage is removed.

#### ■ Graph illustrating the Start-up Time, Rise Time, and Hold-up Time

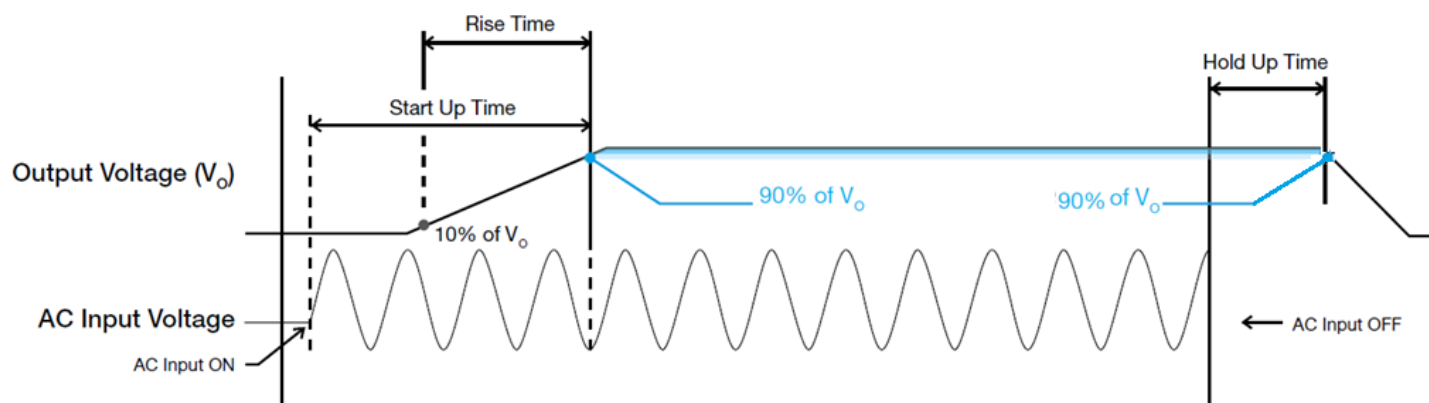

# Medical AC-DC Open Frame Power Supply

## 24 V 400 W 3.5" x 5.5" High Density MDS-400APB24

### Dynamic Response

The power supply output voltage will remain within  $\pm 5\%$  of its steady state value, when subjected to a dynamic load 50 to 100% of its rated current.

#### ■ 50 to 100% Load

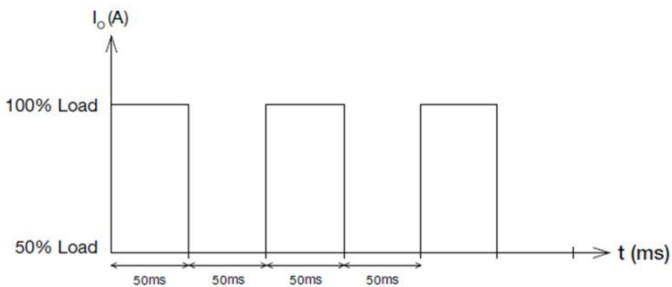

### Inrush Current

Inrush current is the peak, instantaneous, input current measured and, occurs when the input voltage is first applied. For AC input voltages, the maximum peak value of inrush current will occur during the first half cycle of the applied AC voltage. This peak value decreases exponentially during subsequent cycles of AC voltage.

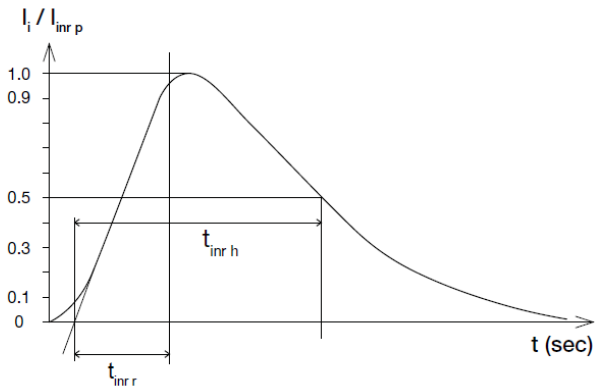

### Overvoltage Protection

The power supply's overvoltage circuit will be activated when its internal feedback circuit fails. The output voltage shall not exceed its specifications defined on Page 4 under "Protections". Power supply will latch off, and require removal/re-application of input AC voltage in order to restart.

### Short Circuit Protection

The power supply's output OLP/OCP function also provides protection against short circuits. When a short circuit is applied, the output current will operate in "Hiccup mode", as shown in the illustration in the OLP/OCP section on this page. The power supply will return to normal operation after the short circuit is removed.

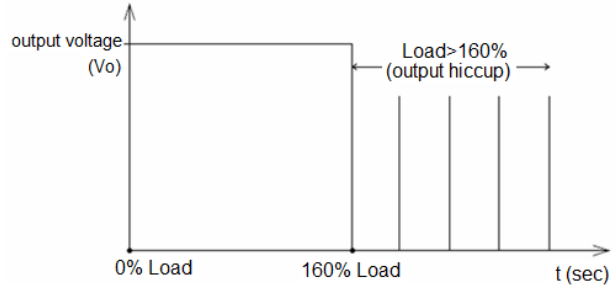

### Overload & Overcurrent Protections

The power supply's Overload (OLP) and Overcurrent (OCP) Protections will be activated before output current under 160% of  $I_o$  (Max load). Upon such occurrence,  $V_o$  will start to drop. Once the power supply has reached its maximum power limit, the protection will be activated and the power supply will go into "Hiccup mode" (Auto-Recovery). The power supply will recover once the fault condition causing the OLP and OCP is removed and  $I_o$  is back within the specified limit.

Additionally, if the load is  $<160\%$  but  $>100\%$  for a prolonged period of time (depending on the load), the Over Temperature Protection (OTP) will be activated due to high temperature on critical components. The power supply will then go into latchmode.

### Over Temperature Protection

As mentioned above, the power supply also has Over Temperature Protection (OTP). This is activated when the overload condition persists for an extended duration and the output current is below the overload trigger point but  $>100\%$  load. In the event of a higher operating temperature condition at 100% load, the power supply will run into OTP when the surrounding air temperature is higher than the operating temperature. When activated, the output voltage will go into latch mode until the input voltage is removed; then, reapplied, and the surrounding air temperature drops to its normal operating temperature.

# Medical AC-DC Open Frame Power Supply

## 24 V 400 W 3.5" x 5.5" High Density MDS-400APB24

### Power Good

Power Good+ pin is an open collector transistor (40 V/600 mA rating). A resistor (suggested value 10Kohm, 1/8W) can be added between 5 V STANDBY pin (or, other available pull-up voltage that is no greater than 30 V) and the Power Good+ pin (refer to figure below). Value of pull-up resistor may have to be adjusted, depending on voltage used, and other end-use conditions of the Power Good+ pin connection to the product. When AC input is on, Power Good+ pin will be high. When AC input is off, Power Good+ pin will be low. There will be a minimum of 3 milliseconds between the time the power good goes to low level, and the time when the output reaches 90% of its rated value.

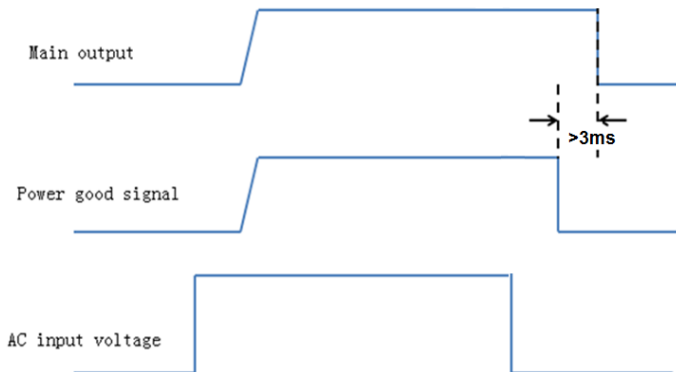
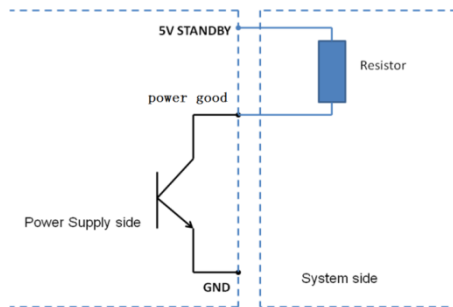

### Remote On\_Off/ INHIBIT

Remote ON\_OFF/ INHIBIT can be used to enable or disable only the main output. This signal can be pulled down to a low level of 0.3 volts, or shorted to DC-Return, in order for the main output to be enabled; and, floated (no connection to the signal), or pulled up to a value greater than or equal to 3 volts, in order to disable the main output.

### Remote Sense

Remote sense feature can be used to compensate for the extra voltage drop on output wires that are connected from the main output terminals, to the load. With wires connected from the remote sense pins, at the same locations as the wires from the main output, the remote sense function can compensate up to 500mV voltage drop. The power supply will not be damaged if the remote sense pins are shorted, or if a reverse/inverted polarity connection is made to the load.

# Medical AC-DC Open Frame Power Supply

## 24 V 400 W 3.5" x 5.5" High Density MDS-400APB24

### Certificate



Delta has been certified as meeting the requirement of ISO 13485: 2003 and EN ISO 13485:2012 for the design and manufacture of switching power supply and adaptor for medical device.



In addition to a UL Total Certification Program (TCP) approved client laboratory for IEC 62368-1. Delta also has participated UL Client Test Data Program (CDTP) for IEC 60601

### Attention

Delta provides all information in the datasheets on an "AS IS" basis and does not offer any kind of warranty through the information for using the product. In the event of any discrepancy between the information in the catalog and datasheets, the datasheets shall prevail (please refer to [www.DeltaPSU.com](http://www.DeltaPSU.com) for the latest datasheets information). Delta shall have no liability of indemnification for any claim or action arising from any error for the provided information in the datasheets. Customer shall take its responsibility for evaluation of using the product before placing an order with Delta.

Delta reserves the right to make changes to the information described in the datasheets without notice.

### Manufacturer and Authorized Representatives Information

#### Manufacturer

##### Thailand

Delta Electronics (Thailand) PCL.  
909 Pattana 1 Rd., Muang, Samutprakarn, 10280 Thailand

##### Taiwan

Delta Electronics, Inc.  
3 Tungyuan Road, Chungli Industrial Zone, Taoyuan County  
32063, Taiwan

#### Authorized Representatives

##### The Netherlands

Delta Greentech (Netherlands) B.V.  
Zandsteen 15, 2132 MZ Hoofddorp, The Netherlands

##### United Kingdom

Delta Electronics Europe Limited  
1 Redwood Court, Peel Park Campus,  
East Kilbride, Glasgow, G74 5PF, United Kingdom