

JPVI

JPVI LED Driver 24V 20W / JPVI-020024FA

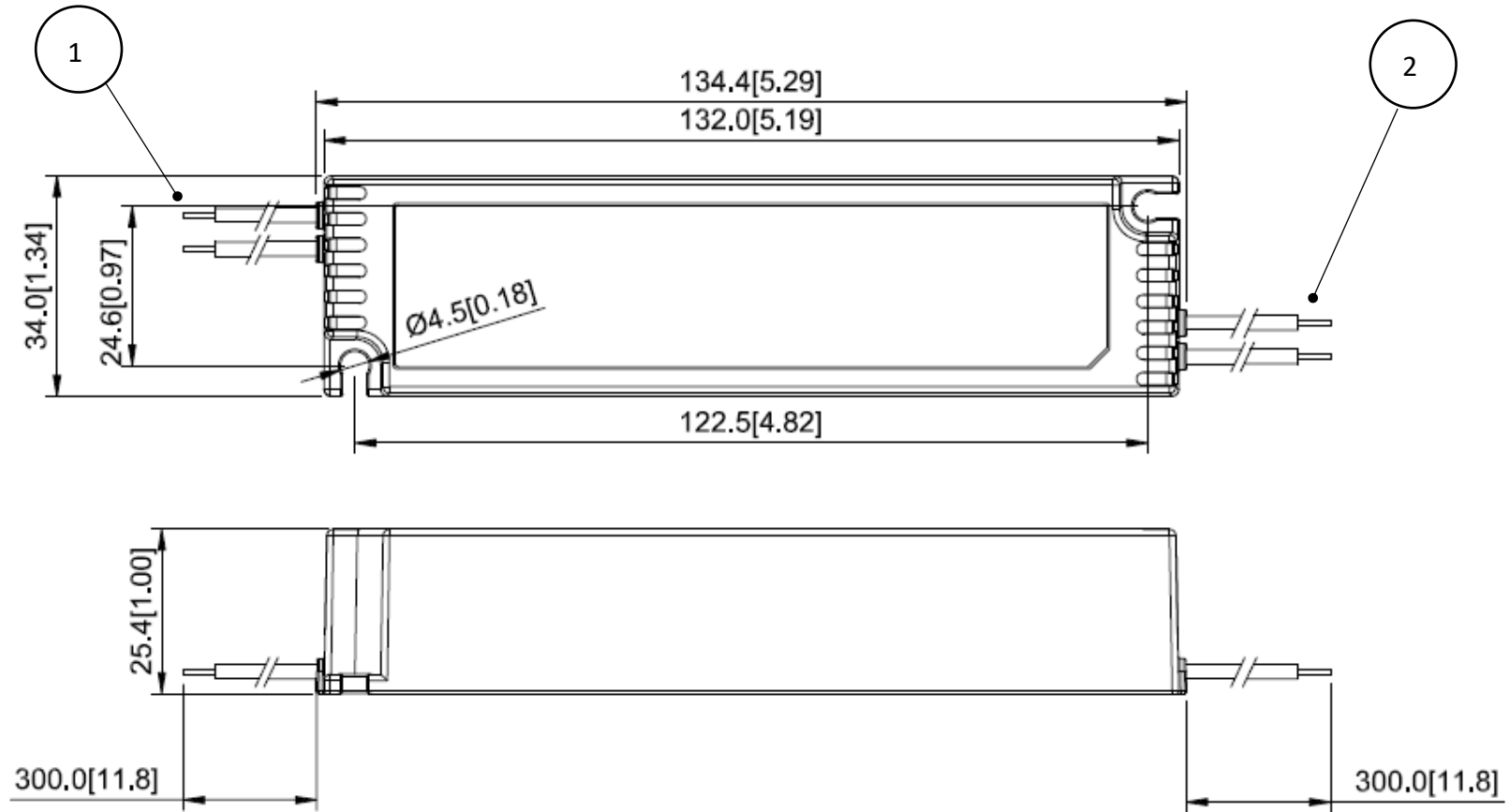

Item	Device Description
1	Input Wire, AC/L (BLACK), AC/N (WHITE)
2	Output Wire, V+ (RED), V- (BLUE)