

LNE

LNE LED Driver

24V 120W 1 Phase / LNE-24V120WACA

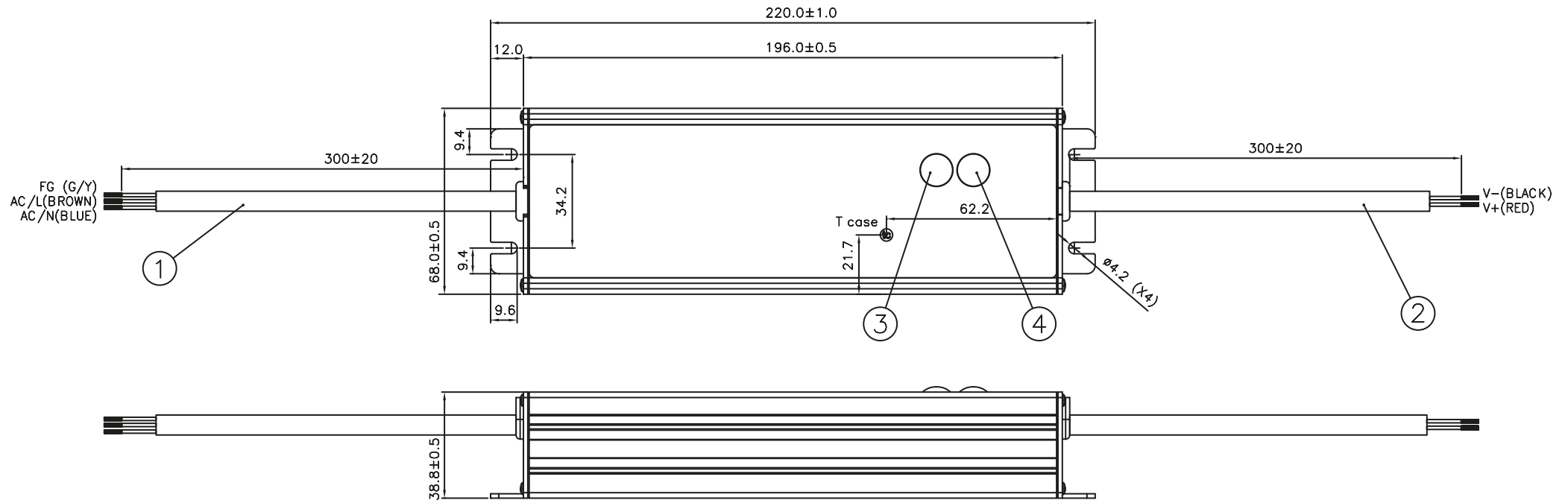

Item	Device Description
1	Input Cable
2	Output Cable
3	Vo Adjust (Constant Voltage Adjustment)
4	Io Adjust (Constant Current Adjustment)
tc	T case (tc): Temperature hot spot location on case.

LNE

LNE LED Driver

24V 120W 1 Phase / LNE-24V120WAAA

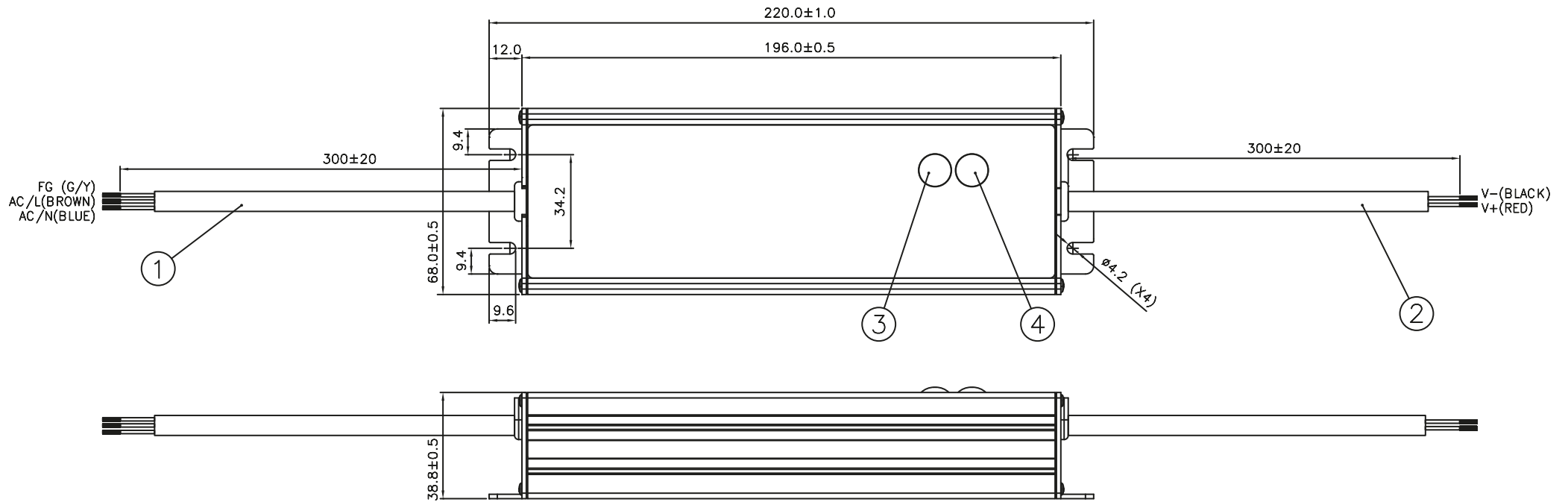

Item	Device Description
1	Input Cable
2	Output Cable
3	Vo Adjust (Constant Voltage Adjustment)
4	Io Adjust (Constant Current Adjustment)

LNE

LNE LED Driver

24V 120W 1 Phase / LNE-24V120WDCA

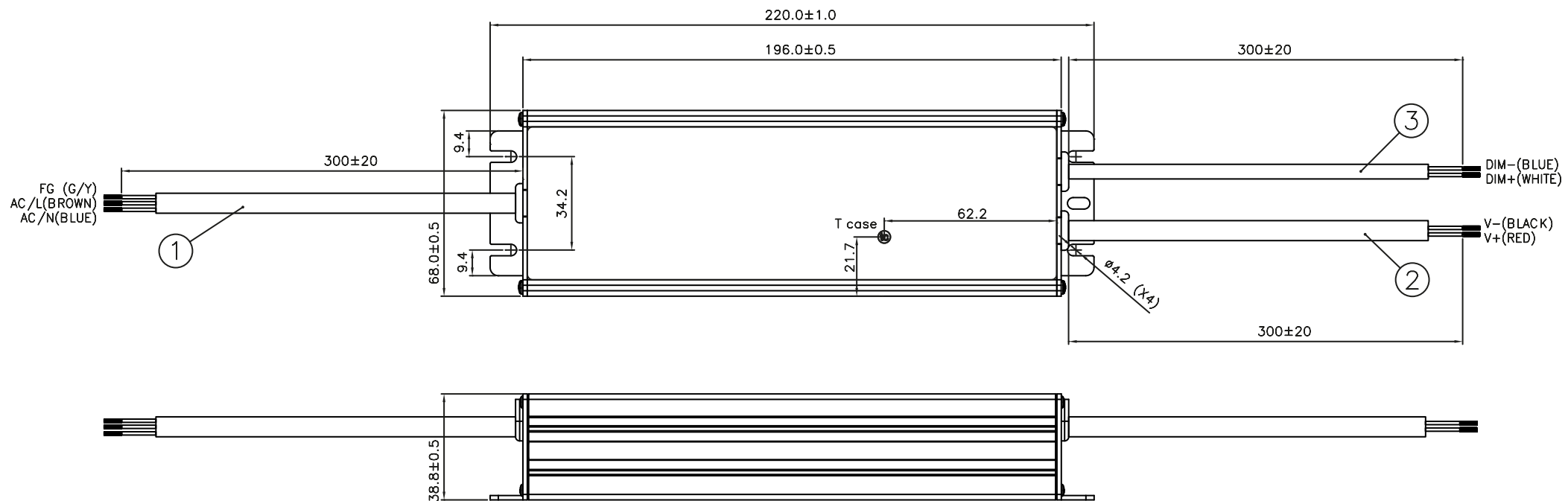

Item	Device Description
1	Input Cable
2	Output Cable
3	Dimming Cable
tc	T case (tc): Temperature hot spot location on case.

LNE

LNE LED Driver

24V 120W 1 Phase / LNE-24V120WDAA

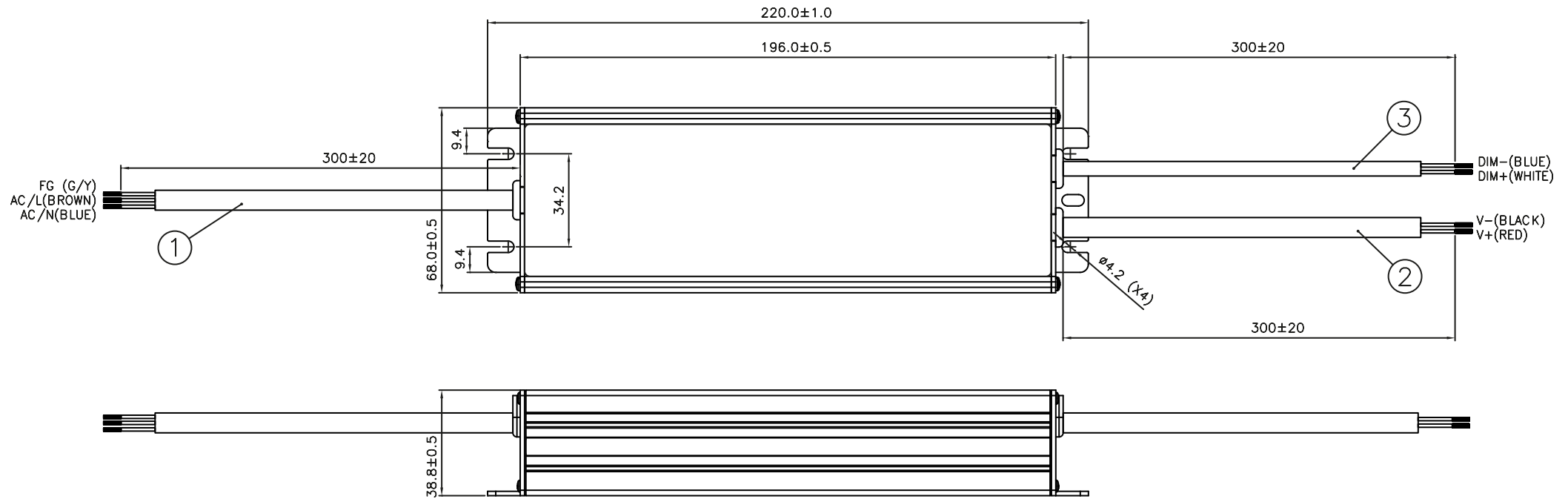

Item	Device Description
1	Input Cable
2	Output Cable
3	Dimming Cable