

# Medical / Industrial AC-DC Power Supply

## 500 W 3" x 5" / MEP-500A□J □RA

# MEP-500A



### Highlights & Features

- 3" x 5" x 1.3" low-profile design
- Up to 25.64 W/inch<sup>3</sup> power density
- Up to 500 W output with fan cooling
- 5V / 2A standby output
- Built-in remote on off function
- Remote sense voltage compensation
- Digital voltage trimming
- Up to 85°C operating temperature
- Medical, IT and household appliances safety approvals

### Safety Certifications



**Model Number:** MEP-500A□J □RA  
**Unit Weight:** 0.41 kg (0.904 lb) (Open Frame)  
**Dimensions (W x L x H):** 76.2 x 127.0 x 33.1 mm (3.0 x 5.0 x 1.3 inch)

### General Description

The MEP-500A offers 500W output power and 4 output voltage of 12 V, 18 V, 24 V and 48 V in a 3" x 5" footprint. It supports up to 500 W output power in a wide operating temperature ranging from -30°C to +85°C. With 5V/2A standby power and electric shock protection complying with 2 x MOPP, the MEP-500A offers reliable power supply for type BF medical equipment. The MEP-500A is certified with medical, IT and home appliance safety approvals, including UL/ TUV/ CE and CB certification, as well as EMC approvals to EN 55032 Class B.

### Model Information

Model Number	Main Output Voltage	Main Output Current	Standby Output Voltage	Standby Output Current	Fan Output Voltage	Fan Output Current
MEP-500A12J □RA	10.8-13.2 Vdc	41.7 A	5 Vdc	2 A	12V	0.6A
MEP-500A18J □RA	15.0-18.0 Vdc	27.8 A	5 Vdc	2 A	12V	0.6A
MEP-500A24J □RA	21.6-26.4 Vdc	20.9 A	5 Vdc	2 A	12V	0.6A
MEP-500A48J □RA	48.0-55.0 Vdc	10.5 A	5 Vdc	2 A	12V	0.6A

### Model Numbering

						CC Code	
MEP –	500	A	□	J	□	□	RA
ME: Delta Medical Power Supply P: Open frame	Max Wattage in Product Series 500: 500 W	Family Code	Output Voltage (Single Output) 12 – 12V 18 – 18V 24 – 24V 48 – 48V	Input Connector Type J: JST connector	Blank	Package Type B: Open frame	Delta Standard, No conformal coating with remote on off



# Medical / Industrial AC-DC Power Supply

## 500 W 3" x 5" / MEP-500A□J □RA

### Specifications

#### Input Ratings / Characteristics

Model Number		MEP-500A12J	MEP-500A18J	MEP-500A24J	MEP-500A48J
Nominal Input Voltage		100-240 Vac			
Input Voltage Range		85-264 Vac			
Nominal Input Frequency		50-60 Hz			
Input Frequency Range		47-63 Hz			
Input Current (max)		6.5 A @ 115 Vac, 4.0 A @ 230 Vac			
Efficiency @ full load (typ.)	@ 115 Vac	91%	91.5%	92.0%	92.0%
	@ 230 Vac	94%	94.5%	95.0%	95.0%
No load Power Consumption (typ.) <sup>*1</sup>		0.2 W @ 230 Vac			
Inrush Current (max.)		60 A @ 230 Vac, cold start			
Power Factor (typ.)		0.99 @ 115 V/60 Hz, full load 0.94 @ 230 Vac/ Hz, full load			
Earth leakage current (max)		0.1 mA @ NC, 0.5 mA @ SFC <sup>*2</sup>			
Touch current (max)		0.1 mA @ NC, 0.3 mA @ SFC <sup>*2</sup>			

\*1 Remote off state

\*2 NC: normal condition, SFC: single fault condition

#### Output Ratings / Characteristics<sup>\*2</sup>

Model Number		MEP-500A12J	MEP-500A18J	MEP-500A24J	MEP-500A48J
Nominal Output Voltage		12 Vdc	18 Vdc	24 Vdc	48 Vdc
Factory Set Point Tolerance		12 Vdc ± 1%	18 Vdc ± 1%	24 Vdc ± 1%	48 Vdc ± 1%
Output Voltage Adjustment Range		10.8-13.2 Vdc	15.0-18.0 Vdc	21.6-26.4 Vdc	48.0-55.0 Vdc
Output Current		41.7A	27.8A	20.9A	10.5A
Output Power (max) @16CFM Fan Cooling		500.4 W	500.4 W	501.6 W	504 W
Output Power (max) @Convection Cooling		300 W	300.6 W	300 W	300 W
Line Regulation (max)		± 0.5%			
Load Regulation (max)		± 1%			
PARD <sup>*3</sup> (20 MHz) (typ.)		80 mV	120 mV	140 mV	240 mV
Start-up Time (max)		1000 ms @ 115 Vac & 230 Vac			
Hold-up Time (typ.)		13 ms @ 115 Vac & 230 Vac (100% load)			
Rise Time (max)		100 ms @ 115 Vac & 230Vac			
Dynamic Response (Overshoot & Undershoot O/P Voltage)		± 10% @ with 5-100% load change, (50% duty @ 5 Hz & 10 KHz, 2.5 A/us slew rate)			
Start-up with Capacitive loads		8,000 µF Max	8,000 µF Max	8,000 µF Max	5,000 µF Max
Remote Sense		Up to 500 mV compensation for voltage drop across external wire connections to load. Short and reverse connection protected.			

\*3 PARD is measured with an AC coupling mode, and in parallel to end terminal with 0.1 µF ceramic capacitor & 47 µF electrolytic capacitor.  
PSU need to burn in > 5 minutes.

# Medical / Industrial AC-DC Power Supply

## 500 W 3" x 5" / MEP-500A□J □RA

### Output Ratings / Characteristics

Model Number	MEP-500A12J	MEP-500A18J	MEP-500A24J	MEP-500A48J
Nominal Output Voltage of Standby output	5 Vdc			
Nominal Output Current of Standby output	2A			
Total Regulation of Standby output	± 3%			
PARD (20 MHz) of Standby output*4 (typ.)	100 mV			

\*4 PARD is measured with an AC coupling mode, and in parallel to end terminal with 0.1 μF ceramic capacitor & 47 μF electrolytic capacitor.  
PSU need to burn in > 5 minutes.

### Mechanical

Dimensions (W x L x H)	Open Frame	76.2 x 127.0 x 33.1 mm (3.0 x 5.0 x 1.3 inch)
Unit Weight	Open Frame	0.41 kg (0.904 lb)
Cooling System		Convection / Force air
Terminal	Input	JST: B2P3-VH(LF)(SN) or equivalent
	Output	M4 x 0.7
	Control	HIROSE : DF1BZ-4DP-2.5DSA or equivalent HIROSE : DF1BZ-4DP-2.5DS or equivalent JST : B2B-EH-A(LF)(SN) or equivalent(only 12V for DC FAN) JST : S2B-EH(LF)(SN) or equivalent(for DC FAN)
Wire	Main Output	AWG 22-18

### Environment

Surrounding Air Temperature <sup>*5</sup>	Operating	-30°C to +85°C (-40°C Cold Start)
	Storage	-40°C to +85°C
Temperature Power De-rating		See power de-rating curves below
Line Power De-rating		< 115Vac de-rate power by 0.67% / Vac Note: see power de-rating curves below
Operating Humidity		10-95% RH (Non-Condensing)
Operating Altitude		Up to 5,000 meters (up to 16,400 feet or 106-54 kPa)
Shock Test (Non-Operating)		50 G, 11 ms, 3 shocks for each direction
Vibration (Non-Operating)		5-500 Hz, 2.09 Grms, 20 minutes for each three axis
Over Voltage Category		II
Pollution Degree		3

\*5 If the surrounding air temperature exceeds 70°C, please consult the local sales representative or contact info@deltapsu.com for further guidance.

# Medical / Industrial AC-DC Power Supply

500 W 3" x 5" / MEP-500A□J □RA

Line Power De-rating Curve

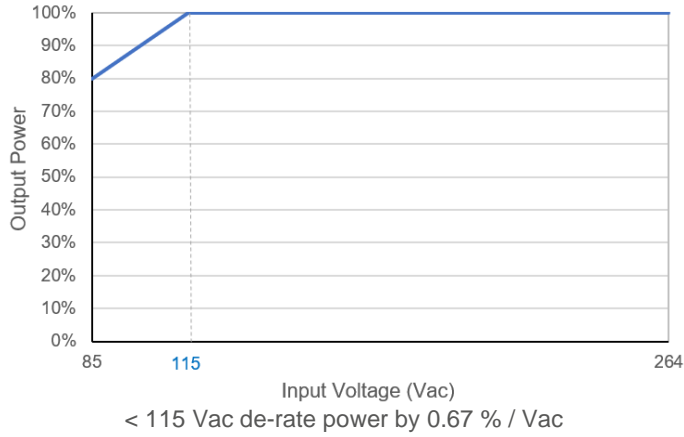

Power De-rating Curve (Force Air)

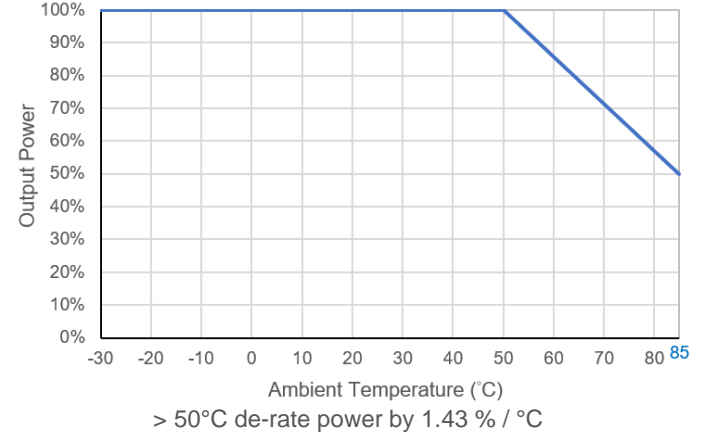

Power De-rating Curve (Convection)

MEP-500A12J BRA, MEP-500A18J BRA

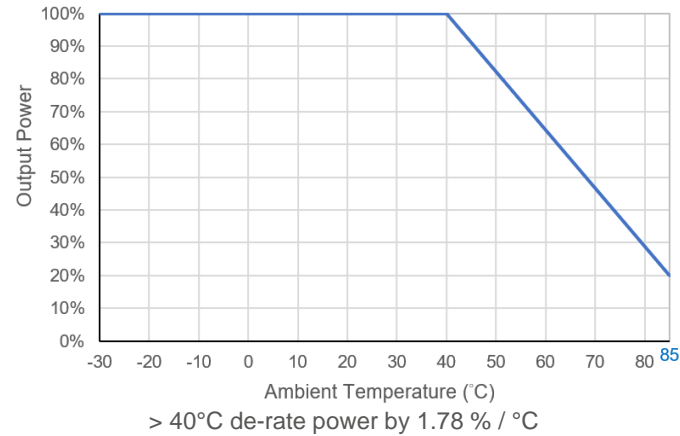

MEP-500A24J BRA, MEP-500A48J BRA

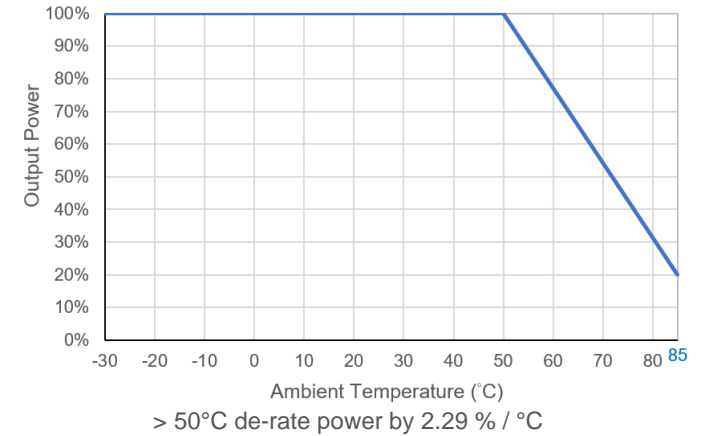

5V Standby Power De-rating Curve (Convection)

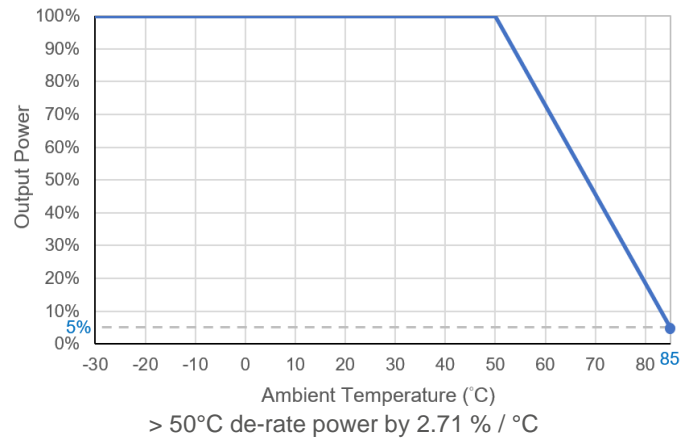

12V Fan Power De-rating Curve (Convection)

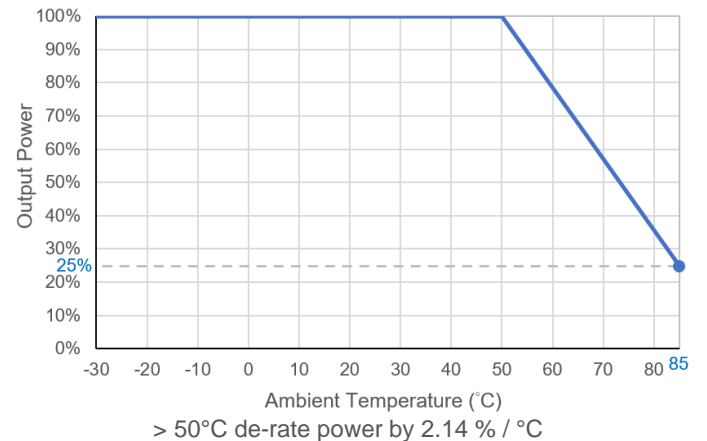

# Medical / Industrial AC-DC Power Supply

## 500 W 3" x 5" / MEP-500A□J □RA

### Thermal Fixture and Test Setup

#### MEP-500A□J BRA (Open Frame)

(FAN P/N: DELTA AFB0512SN)

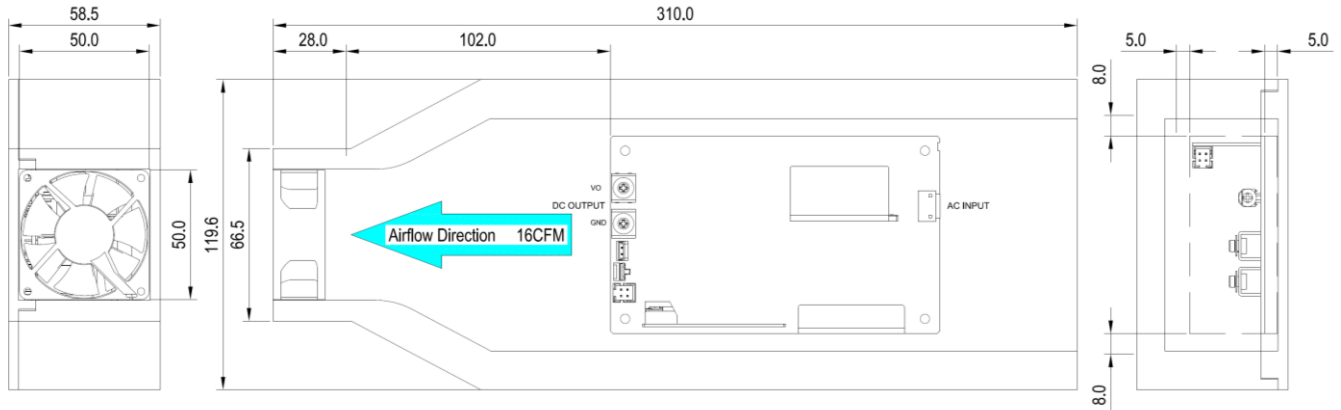

### Protections

Overvoltage	Main output 105-150% of rated normal voltage, Latch mode
Over load / Over current	Main output 105-185% of rated current, Hiccup Mode
Over Temperature	Latch Mode
Short Circuit	Hiccup Mode (Non-Latching, Auto-Recovery)
Protection Against Shock	Open Frame Class I / II

### Reliability Data

MTBF at 115 Vac, 100% load, 35 °C convection air	1000K hrs based on Telecordia SR-332
Operating life at 115 Vac, 100% load, 25 °C, 16CFM	3 years

### Safety Standards / Directives

Medical Safety	IEC 60601-1 CB report TUV EN60601-1 ANSI/AAMI ES 60601-1+CAN/CSA-C22.2 No.60601-1
ITE Safety	IEC 62368-1 CB report TUV EN 62368-1 UL 62368-1 and CAN/CSA C22.2 No. 62368-1
Home Appliance	IEC 60335-1 CB report IEC 61558-1 /-2-16 CB report
CE	In conformance with EMC Directive 2014/30/EU and Low Voltage Directive 2014/35/EU EN 60601-1: 2006 + A1: 2013 + A12: 2014 & EN 60601-1-2: 2015
Galvanic Isolation	Input to/Output (2xMOPP) 4000 Vac Input to/Ground (1xMOPP) 2500 Vac Output to/Ground (1xMOPP) 1500 Vac (Type BF application rated)

# Medical / Industrial AC-DC Power Supply

500 W 3" x 5" / MEP-500A□J □RA

## EMC

Emissions (CE & RE)		EN55032 Class B, AS/NZS CISPR32 Class B Note: Class A Radiated Emission and Conducted Emission for Class II connection without earth connection
Harmonic Current Emissions	IEC 61000-3-2	Meet Class D limit
Immunity to		
Voltage Flicker	IEC 61000-3-3	
Electrostatic Discharge	IEC 61000-4-2	Level 4 Criteria A <sup>1)</sup> Air Discharge: 15 kV Contact Discharge: 8 kV
Radiated Field	IEC 61000-4-3	Criteria A <sup>1)</sup> 80 MHz-2700 MHz, 10 V/m AM modulation
Electrical Fast Transient / Burst	IEC 61000-4-4	Level 4 Criteria A <sup>1)</sup> : 4 kV
Surge	IEC 61000-4-5	Level 3 Criteria A <sup>1)</sup> Common Mode <sup>3)</sup> : 2 kV Differential Mode <sup>4)</sup> : 1 kV
Conducted	IEC 61000-4-6	Level 2 Criteria A <sup>1)</sup> 150 kHz-80 MHz, 3 Vrms, 6 Vrms, 20 Vrms at ISM bands and Amateur radio bands
Power Frequency Magnetic Fields	IEC 61000-4-8	Criteria A <sup>1)</sup> Magnetic field strength 30 A/m
Voltage Dips	IEC 61000-4-11	30% 10ms Criteria A, 60% 100ms Criteria B 100% 5000ms Criteria B
Voltage Dips <sup>5)</sup>	IEC 60601-1-2	Criteria A <sup>2)</sup> 0% U <sub>T</sub> , 0.5 cycle (10 ms), (0°,45°,90°,135°,180°,225°,270°,315°,360°) Criteria B <sup>2)</sup> 0% U <sub>T</sub> , 1 cycle (20 ms), 0° Criteria A <sup>2)</sup> 70% U <sub>T</sub> , 25 cycle (500 ms), 0° Criteria B <sup>2)</sup> 0% U <sub>T</sub> , 250 cycle (5000 ms), 0°

1) Criteria A: Normal performance within the specification limits

2) Criteria B: Output out of regulation, or shuts down during test. Automatically restored to normal operation after test.

3) Asymmetrical: Common mode (Line to earth)

4) Symmetrical: Differential mode (Line to line)



# Medical / Industrial AC-DC Power Supply

## 500 W 3" x 5" / MEP-500A□J □RA

### Assembly & Installation

#### MEP-500A□J BRA (Open Frame)

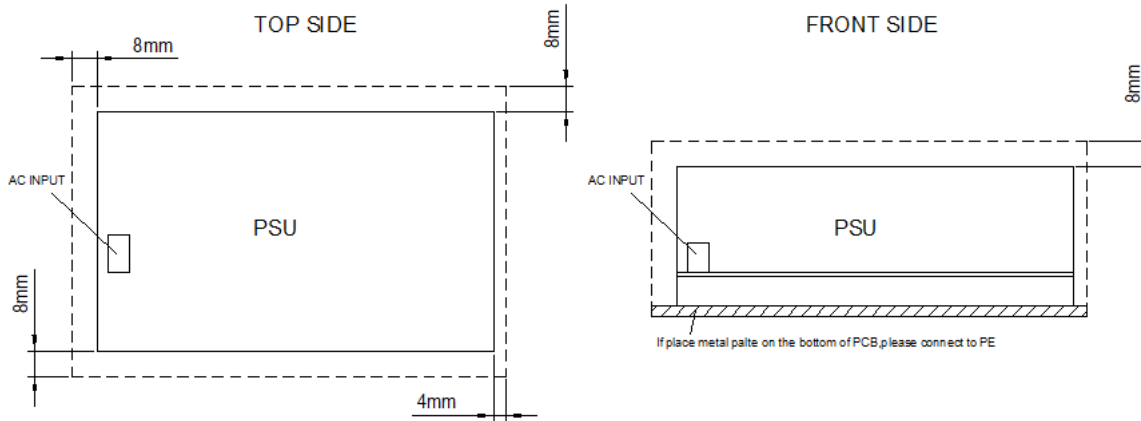

#### Notes:

For safety reasons, please ensure that the mounted device maintains the following safety distances from other components and equipment on all sides:

a) For Open Frame Type:  $\geq 8$  mm (0.315 inch) from the primary side and  $\geq 4$  mm (0.16 inch) from the secondary side.

Please insert an insulation sheet between the system and product if the safety distance is less than 4 mm (0.16 inch).

- Use flexible cables (stranded or solid) of AWG No. 22-18.
- For the Remote ON/OFF function, use flexible cables (stranded or solid) of AWG No. 28-24

Please connect to PE, if place the metal plate on the bottom of PCB.



# Medical / Industrial AC-DC Power Supply

500 W 3" x 5" / MEP-500A□J □RA

## Functions

### Start-up Time

The time required for the output voltage to reach 90% of its final steady state value, after the input voltage is applied.

### Rise Time

The time required for the output voltage to change from 10% to 90% of its final steady state value.

### Hold-up Time

Time between the collapse of the AC input voltage, and the output falling to 90% of its steady state value.

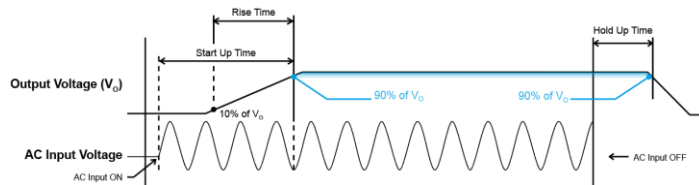

Figure 1. Time Sequence

### Dynamic Response (Main Output)

The power supply output voltage will remain within  $\pm 10\%$  of its steady state value, when subjected to a dynamic load 5% to 100% of its rated current.

#### ■ 5% to 100% Load

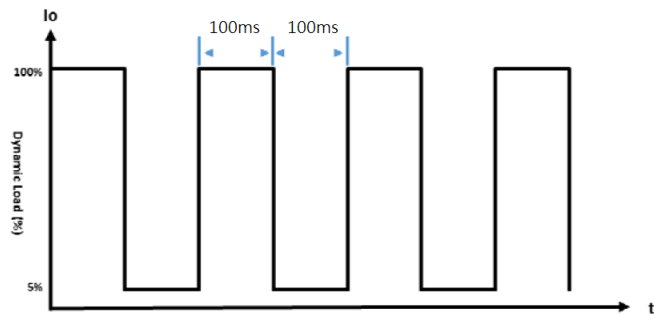

Figure 2-1. Dynamic Load (5 Hz)

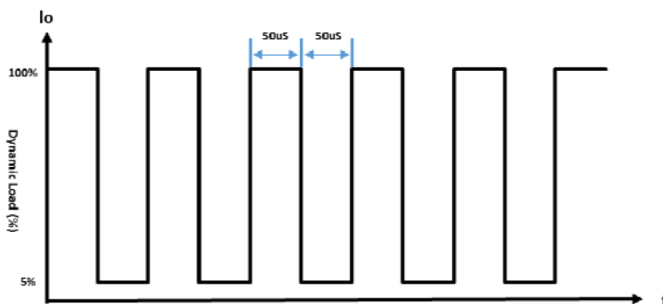

Figure 2-2. Dynamic Load (10K Hz)

### Inrush Current

Inrush current is the input current that occurs when the input voltage is first applied. For AC input voltages, the maximum peak value of inrush current will occur during the first half cycle of the applied AC voltage. This peak value decreases exponentially during subsequent cycles of AC voltage.

### Overvoltage Protection

The power supply's overvoltage circuit will be activated when its internal feedback circuit fails. The output voltage shall not exceed its specifications defined on Page 4 under "Protections". Power supply will latch off, and require removal/re-application of input AC voltage in order to restart.

### Overload & Over current Protections

The power supply's Overload (OLP) and Over current (OCP) Protections will be activated before output current under 185% of  $I_o$  (Max load). Upon such occurrence,  $V_o$  will start to drop. Once the power supply has reached its maximum power limit, the protection will be activated and the power supply will go into "Hiccup mode" (Auto-Recovery). The power supply will recover once the fault condition causing the OLP and OCP is removed and  $I_o$  is back within the specified limit.

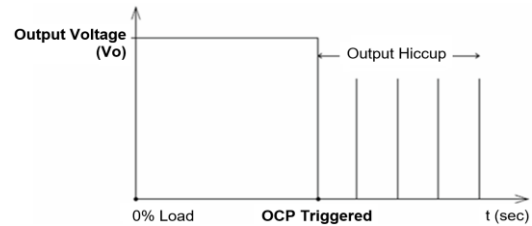

Figure 3. Hiccup at OLP/OCP

Additionally, if the  $I_{out}$  is  $>100\%$  for a prolong period of time (depending on the load), the Over Temperature Protection (OTP) may be activated due to high temperature on critical components. The power supply will then go into latch mode.

### Short Circuit Protection

Output OLP/OCP function also provides protection against short circuits. When a short circuit is applied, the output current will operate in "Hiccup mode", The power supply will return to normal operation after the short circuit is removed.

### Over Temperature Protection

As mentioned above, the power supply also has Over Temperature Protection. This is activated when the overload condition persists for an extended duration and the output current is below the overload trigger point but  $>100\%$  load. In the event of a higher operating temperature condition at 100% load, the power supply will run into OTP when the surrounding air temperature is higher than the operating temperature. When activated, the output voltage will go into latch mode until the input voltage is removed; then, reapplied, and the surrounding air temperature drops to its normal operating temperature.

# Medical / Industrial AC-DC Power Supply

## 500 W 3" x 5" / MEP-500A□J □RA

### Voltage Adjustment

The power supply provides a potentiometer for user to adjust the output voltage. When the output is adjusted below nominal value, the maximum output current is the same as the nominal output, when the output is adjusted above nominal value, the output power cannot exceed the nominal maximum power (the maximum output current will be reduced accordingly).

### Power Good

Power Good+ pin is an open collector transistor. No additional resistors are required between Power Good + pin and Power Good – pin (refer to Figure 4 below). When AC input is on, Power Good+ pin will be high. When AC input is off, Power Good+ pin will be low. There will be a minimum of 3 milliseconds (at 500W load) between the time the power good goes to low level, and the time when the output reaches 90% of its rated full load.

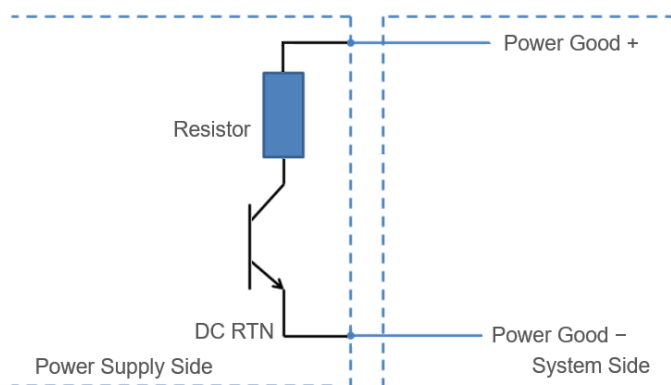

Figure 4. Power Good Connection

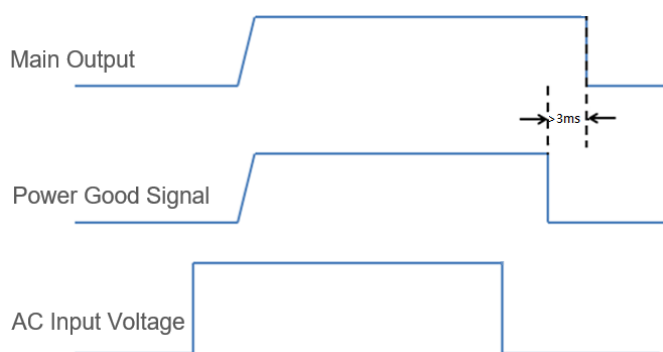

Figure 5. Power Good Time Sequence

### Remote On\_Off/Inhibit

Remote ON\_OFF/INHIBIT can be used to enable or disable only the main output. When the main output is disabled, the 5V STANDBY + will continue to operate. This signal can be pulled down to a low level of 0.3 volts, or shorted to GND, in order for the main output to be disabled; and, floated (no connection to the signal), or pulled up to a value greater than or equal to 3 volts, in order to enable the main output.

### Remote Sense

Remote sense feature can be used to compensate for the extra voltage drop on output wires that are connected from the main output terminals, to the load. With wires connected from the remote sense pins, at the same locations as the wires from the main output, the remote sense function can compensate up to 500mV voltage drop. The power supply will not be damaged if the remote sense pins are shorted, or if a reverse/inverted polarity connection is made to the load. PSU can work normally without remote sense connection and left open the remote sense pins.

# Medical / Industrial AC-DC Power Supply

## 500 W 3" x 5" / MEP-500A□J □RA

### Certificate



All Delta Medical Power products conform to the European directive 2011/65/EU.  
ROHS is the abbreviation for "Restriction of the use of certain hazardous substances"



Delta has been certified as meeting the requirement of ISO 13485: 2003 and EN ISO 13485:2012 for the design and manufacture of switching power supply and adaptor for medical device.



In addition to a UL Total Certification Program (TCP) approved client laboratory for IEC60950 and IEC60065. Delta also has participated UL Client Test Data Program (CDTP) for IEC 60601

### Attention

Delta provides all information in the datasheets on an "AS IS" basis and does not offer any kind of warranty through the information for using the product. In the event of any discrepancy between the information in the catalog and datasheets, the datasheets shall prevail (please refer to [www.DeltaPSU.com](http://www.DeltaPSU.com) for the latest datasheets information). Delta shall have no liability of indemnification for any claim or action arising from any error for the provided information in the datasheets. Customer shall take its responsibility for evaluation of using the product before placing an order with Delta.

Delta reserves the right to make changes to the information described in the datasheets without notice.

### Manufacturer and Authorized Representatives Information

#### Manufacturer

##### Thailand

Delta Electronics (Thailand) PCL.  
909 Pattana 1 Rd., Muang, Samutprakarn, 10280 Thailand

##### Taiwan

Delta Electronics, Inc.  
3 Tungyuan Road, Chungli Industrial Zone, Taoyuan County  
32063, Taiwan

#### Authorized Representatives

##### The Netherlands

Delta Greentech (Netherlands) B.V.  
Zandsteen 15, 2132 MZ Hoofddorp, The Netherlands

##### United Kingdom

Delta Electronics Europe Limited  
1 Redwood Court, Peel Park Campus,  
East Kilbride, Glasgow, G74 5PF, United Kingdom