

LED Driver

EUCI BASIC Series



EUCI BASIC

Highlights & Features

- Wireless configuration interface via NFC
- Constant power mode design and wide range of output current adjustable: 200mA - 1050mA
- Programmable function with AOC/CLO/ELO
- Autonomous dimming includes three "Smart Timer Dim" operation with Fixed Timer, Midnight Centric Timer, and Ratio Rescale Timer
- Robustness protection against vibration, harsh operating temperature and moisture with potting
- High efficiency design up to 94%
- High surge immunity protection (10K V /6K V)
- Meet Zhaga dimension criteria

Safety Standards



(SELV for 40W)

Dimensions (L x W x H):

EUCI-040105GBA	133.0 x 77.0 x 40.0 mm (5.24 x 3.03 x 1.57 inch)
EUCI-075105GBA	133.0 x 77.0 x 40.0 mm (5.24 x 3.03 x 1.57 inch)
EUCI-130105GBA	150.0 x 90.0 x 40.0 mm (5.91 x 3.54 x 1.57 inch)
EUCI-170105GBA	170.0 x 100.0 x 40.0 mm (6.6 x 3.94 x 1.57 inch)

General Description

Delta LED drivers come in different series to suit different application needs. The EUCI BASIC series features programmable output current levels. The EUCI BASIC series offers the capability to achieve different level of LED brightness via built-in smart timer time function to meet various application and energy optimization needs. These products are designed and rigorously tested to work with various outdoor LED lighting conditions. Featuring high surge immunity (CM: 10kV, DM: 6kV), which makes Delta EUCI BASIC series an essential part of an energy efficient LED lighting power solution for both industrial and outdoor applications.

Model Information

EUCI BASIC LED Driver

Model Number	Input Voltage Range	Rated Output Voltage	Program Output Current Range	Constant Power Current Range
EUCI-040105GBA	220-240Vac Typical 198-264Vac Range	20-77Vdc	200-1050mA	520-1050mA
EUCI-075105GBA		35-150Vdc	200-1050mA	500-1050mA
EUCI-130105GBA		60-200Vdc	200-1050mA	650-1050mA
EUCI-170105GBA		80-310Vdc	200-1050mA	550-1050mA

Model Numbering

EU	C	I	-	□□□	□□□	G	B	A
Safety Approval CE, ENEC	Constant current	Built-In		Output Power 040 - 40W 075 - 75W 130 - 130W 170 - 170W	Output Current 200-1050mA	Programmable output current (by NFC)	Control type Non-Dimming	A Standard

LED Driver

EUCI BASIC Series

Specifications

Model Number	EUCI-040105GBA	EUCI-075105GBA	EUCI-130105GBA	EUCI-170105GBA
--------------	----------------	----------------	----------------	----------------

Input Ratings / Characteristics

Normal Input Voltage	220-240Vac				
Input Voltage Range	198-264Vac				
Normal Input Frequency	50-60Hz				
Input Frequency Range	47-63Hz				
Max. Input Current	230Vac	0.23A	0.43A	0.68A	0.87A
Efficiency(typ) ¹⁾	230Vac	90% @ 0.52A	92% @ 0.5A	93% @ 0.65A	94% @ 0.55A
	230Vac	88% @ 1.05A	91% @ 1.05A	92% @ 1.05A	93% @ 1.05A
Inrush Current (Apk / 50%-us) (Cold Start)	230Vac	20A/250uS		50A/250uS	70A/250uS
Max. No. of LED Drivers circuit breaker @ 230Vac	B10	28pcs	16pcs	10pcs	8pcs
	B16	46pcs	26pcs	16pcs	12pcs
	C10	28pcs	16pcs	10pcs	8pcs
	C16	46pcs	26pcs	16pcs	12pcs
Power Factor	> 0.95 @ 230Vac, 100% load				
Total Harmonic Distortion (Typical)	< 8% @ 230Vac, 100% load				
Leakage Current	< 0.7mA peak @ 230Vac				
Input Over-Voltage	Can survive input over-voltage stress of 320VAC for 48 hours				

Output Ratings / Characteristics

Output Voltage Range	20-77Vdc	35-150Vdc	60-200Vdc	80-310Vdc
Max. No Load Output Voltage	120V	210V	350V	430V
Output Power Range	40W	75W	130W	170W
Adjustable Output Current (AOC)	200-1050mA			
	With steps of 1mA, configurable via software			
Minimum Output Current (Dim)	55mA (Min dim level)			
Current Accuracy	± 5% @ 0.52A~1.05A	± 5% @ 0.5A~1.05A	± 5% @ 0.65A~1.05A	± 5% @ 0.55A~1.05A
Output Current LF Ripple	4% at full load (<100Hz)			
Start-up Time	<1000ms max. (@ 220-240Vac)			

LED Driver

EUCI BASIC Series

Model Number	EUCI-040105GBA	EUCI-075105GBA	EUCI-130105GBA	EUCI-170105GBA
--------------	----------------	----------------	----------------	----------------

Mechanical

Casing	Plastic, Color : Black			
Dimensions (L x W x H)	[mm]	133.0 x 77.0 x 40.0	150.0 x 90.0 x 40.0	170.0 x 100.0 x 40.0
	[inch]	5.24 x 3.03 x 1.57	5.91 x 3.54 x 1.57	6.69 x 3.94 x 1.57
Unit Weight	[kg]	0.57	0.72	0.99
	[lb]	1.26	1.59	2.18
Weight/carton	[kg]	12	9.14	10.4
Pieces per carton box		20 pcs	12 pcs	10 pcs
Cooling System	Convection			
Input connector	Terminal, 2-pole, Conductor 0.5~1.5 mm ² , Strip length 8.5...9.5mm Line : Gray, Neutral : Gray, Space*1 : Gray, EUQ1 : Gray,			
Output connector	For 40/75/130W, Terminal, 4-pole, Conductor 0.5~1.5 mm ² , Strip length 8.5...9.5mm LED+*2 : Gray, LED- *2 : Gray			
	For 170W, Terminal, 2-pole, Conductor 0.5~1.5 mm ² , Strip length 8.5...9.5mm LED+ : Gray, LED- : Gray			
Noise (30cm distance)	Sound Pressure Level (SPL) < 24dBA			

Environment

Ambient Temperature	Operating	-40°C to +55°C			
	Storage	-40°C to +85°C			
Maximum Case Temperature		85°C	90°C	90°C	90°C
Lifetime @ tc		75°C	80°C	80°C	80°C
Relative Humidity	Operating	10 to 90% RH (Non-Condensing)			
	Storage	5 to 95% RH (Non-Condensing)			

Protections

Open Load Voltage	120Vrms	210Vrms	350Vrms	430Vrms
Overload	Reduce output current. Auto-Recovery when the fault is removed			
Short Circuit	Auto-Recovery when the fault is removed			
Over Temperature	Reduce output current. Auto-Recovery when the fault is removed			
Ingress Protection Classification	IP20			
Suitable for Luminaires Class	Class I/Class II. Insulation Class according to IEC 60598			

Reliability Data

Lifetime	50,000 hours @ Maximum Case Temperature (Please refer to lifetime VS case temperature) 100,000 hours @ Maximum Case Temperature -10deg
MTTF	475,000 hours @ lifetime case temperature (as per Telcordia SR-332, total failure rate less than10%)

LED Driver

EUCI BASIC Series

Model Number	EUCI-040105GBA	EUCI-075105GBA	EUCI-130105GBA	EUCI-170105GBA
--------------	----------------	----------------	----------------	----------------

Safety Standards / Directives

Electrical Safety	IEC 61347-1, IEC 61347-2-13 (Built in) EN 61347-1, EN 61347-2-13, EN IEC 62384 SELV (for 40W)
CE	In conformance with EMC Directive and Low Voltage Directive
Material and Parts	RoHS Directive 2011/65/EU Compliant

Galvanic Isolation (40W)	Mains	EQUI	LED+/LED-
Mains	N/A	Double	SELV
EQUI	Double	N/A	Supplementary
LED+/LED-	SELV	Supplementary	N/A

Galvanic Isolation (75/130/170W)	Mains	EQUI	LED+/LED-
Mains	N/A	Double	Double
EQUI	Double	N/A	Basic
LED+/LED-	Double	Basic	N/A

EMC

Emissions (CE & RE)	Compliance to EN 55015 Class B;		
Immunity	Compliance to EN 61547		
Electrostatic Discharge	IEC 61000-4-2	Air Discharge: 8kV Contact Discharge: 4kV Criteria A ¹⁾ or Criteria B ²⁾	
Radiated Disturbances	IEC 61000-4-3	80MHz-1GHz, 3V/m with 1kHz Sine Wave / 80% Modulation Criteria A ¹⁾	
Electrical Fast Transient / Burst	IEC 61000-4-4	1KV, Criteria A ¹⁾ or Criteria B ²⁾	
Surge	IEC 61000-4-5	Common Mode ³⁾ : 10kV; Differential Mode ⁴⁾ : 6kV, Criteria A ¹⁾ or Criteria B ²⁾	
Conducted Disturbances	IEC 61000-4-6	150kHz-80MHz, 3Vrms ,Criteria A ¹⁾	
Power Frequency Magnetic Fields	IEC 61000-4-8	3A/Meter, Criteria A ¹⁾	
Voltage Dips	IEC 61000-4-11	100% dip; 0.5 cycle, Criteria A ¹⁾ or Criteria B ²⁾ 30% dip; 10 cycle, Criteria A ¹⁾ or Criteria B ²⁾	
Harmonic Current Emission	IEC 61000-3-2	Class C (230Vac @ ≥ 50% load)	
Voltage Fluctuation & Flicker	IEC 61000-3-3	Pst <1, Plt <0.65	

1) Criteria A: Normal performance within the specification limits
2) Criteria B: Temporary degradation or loss of function, which is self-recoverable

3) Asymmetrical: Common mode (Line to earth)
4) Symmetrical: Differential mode (Line to line)

Default Settings of the Driver (can be changed with NFC programming tools)

Adjustable Output Current (AOC)	520mA	500mA	650mA	550mA
Smart Timer DIM	Disabled. Settable though programming tools			
Constant Lumen Output (CLO)	Disabled. Settable though programming tools.			
End of Life indication (EOL)	Disabled. Settable though programming tools			

LED Driver

EUCI BASIC Series

Lifetime VS Case Temperature

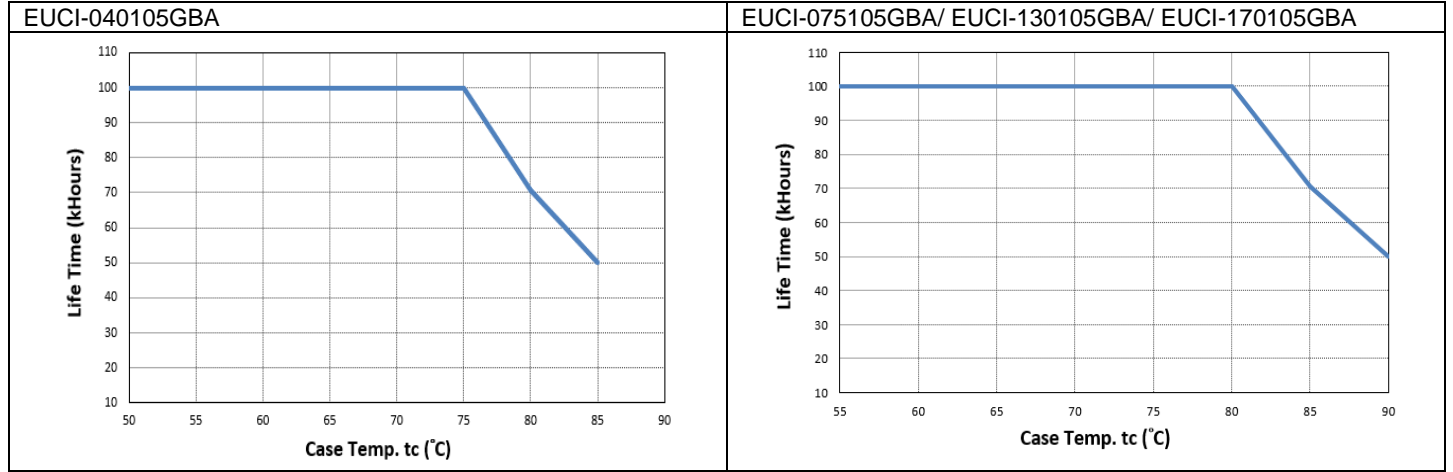

Output and Dimming Characteristic Curve

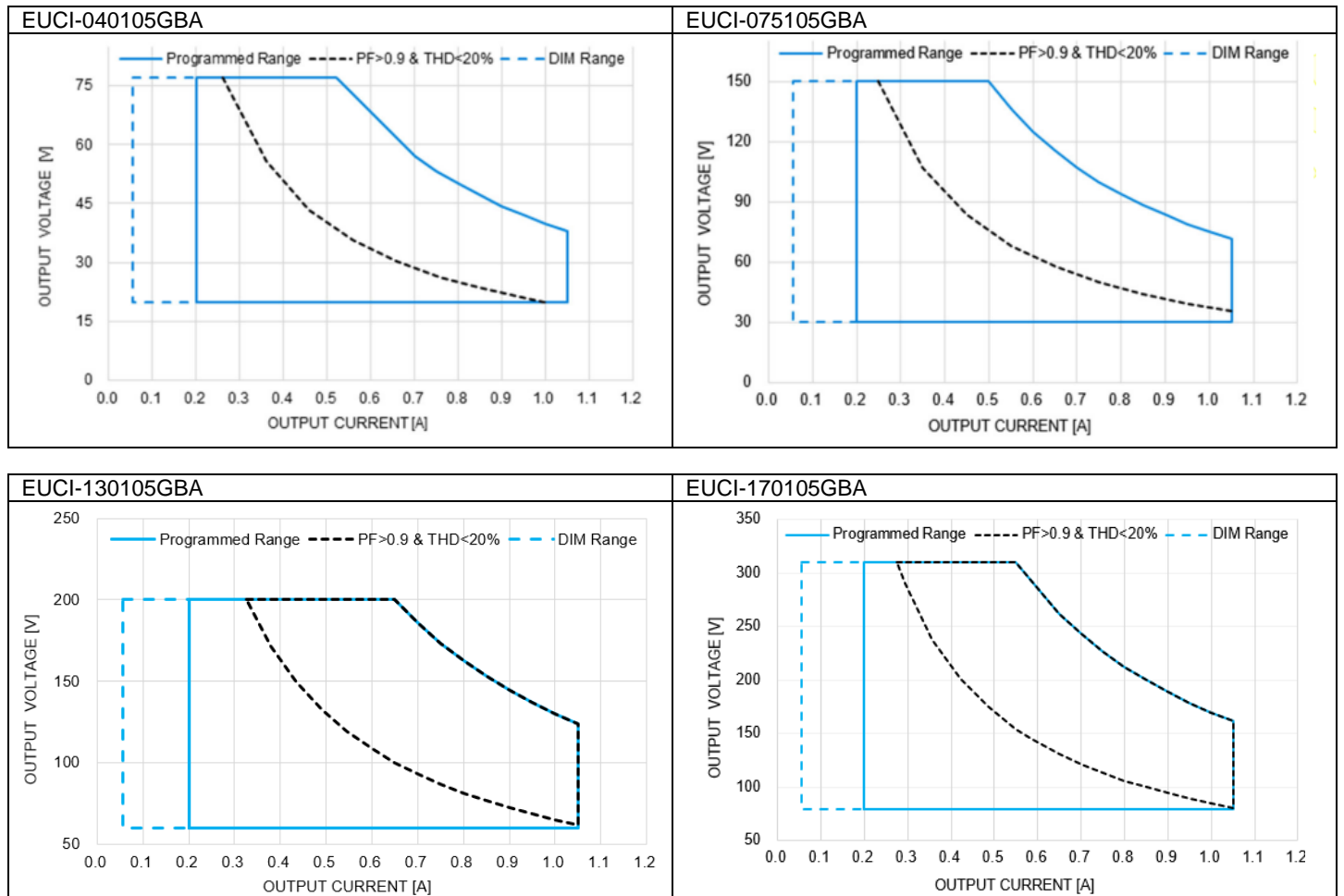

LED Driver

EUCI BASIC Series

Efficiency VS Output Power

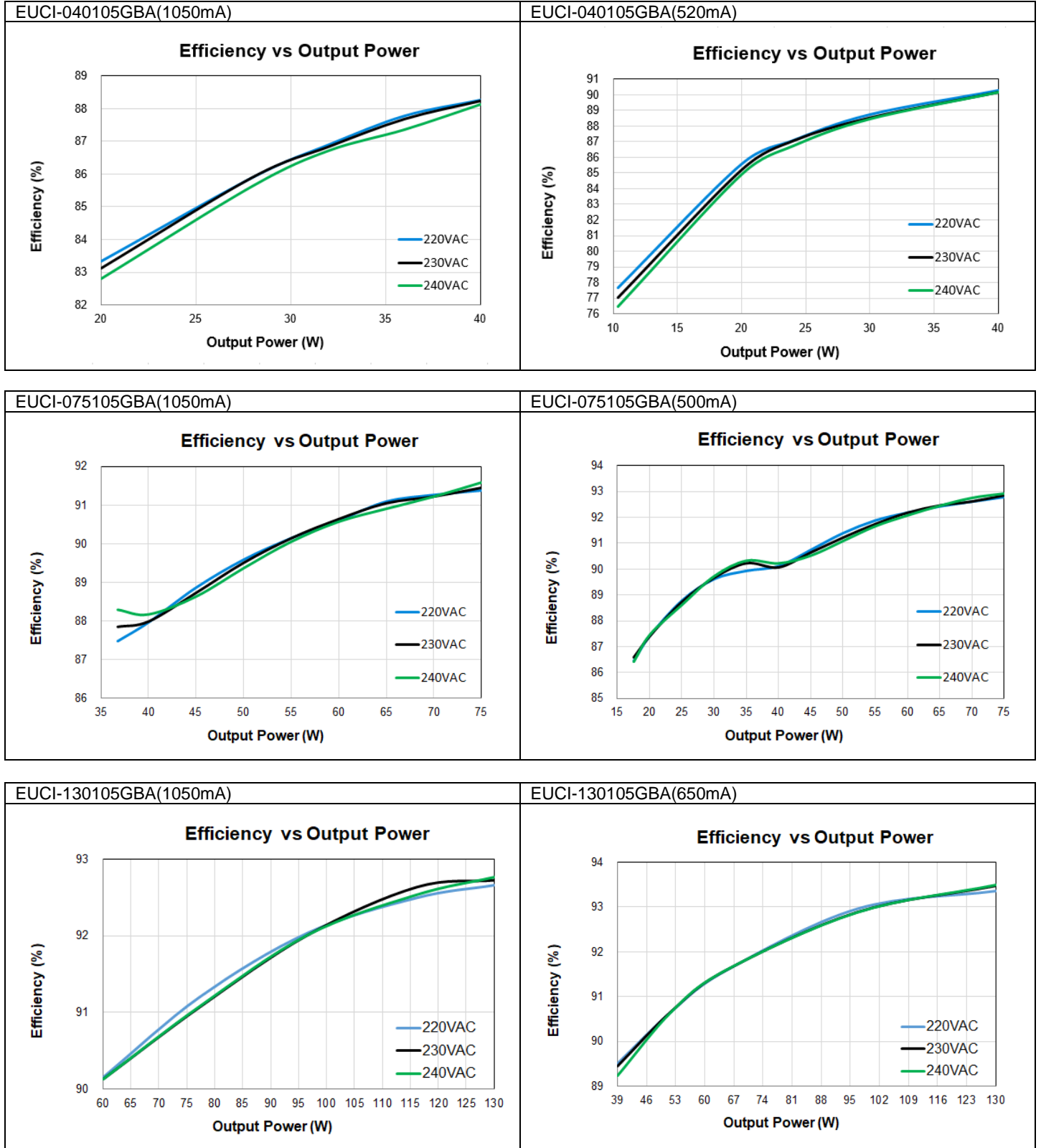

LED Driver

EUCI BASIC Series

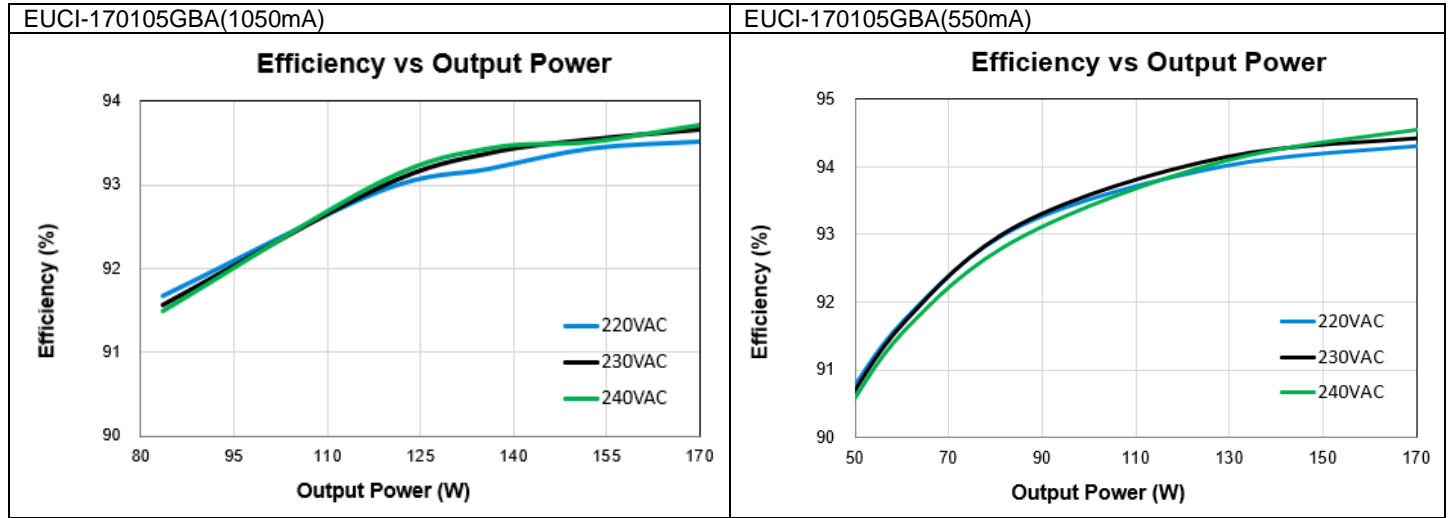

Power Factor VS Output Power

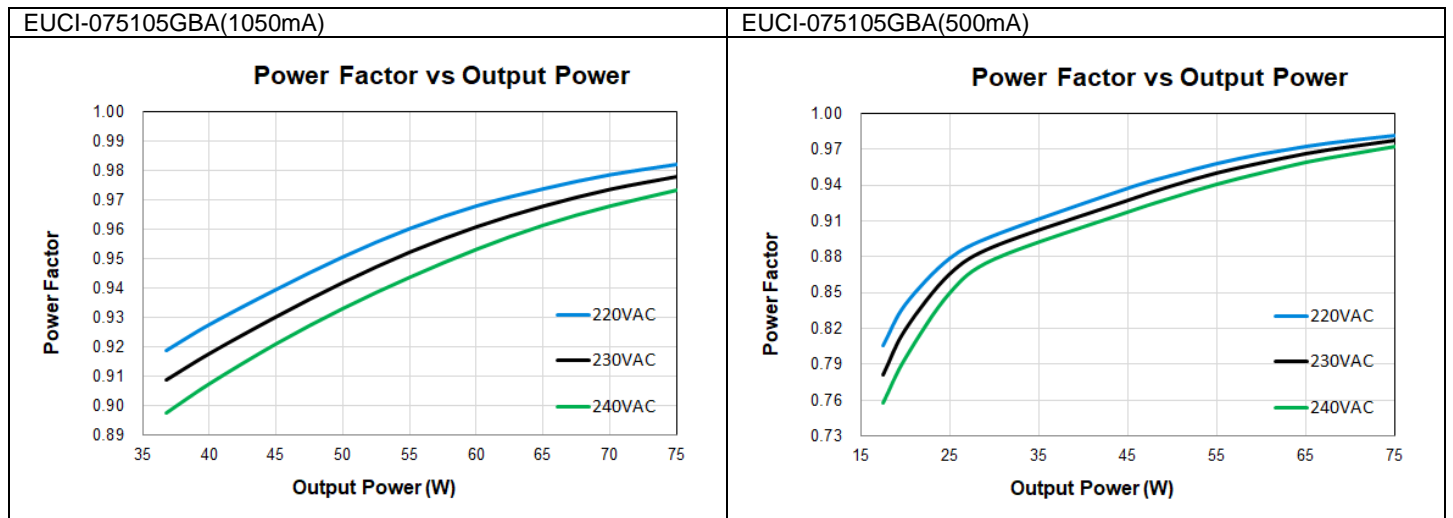
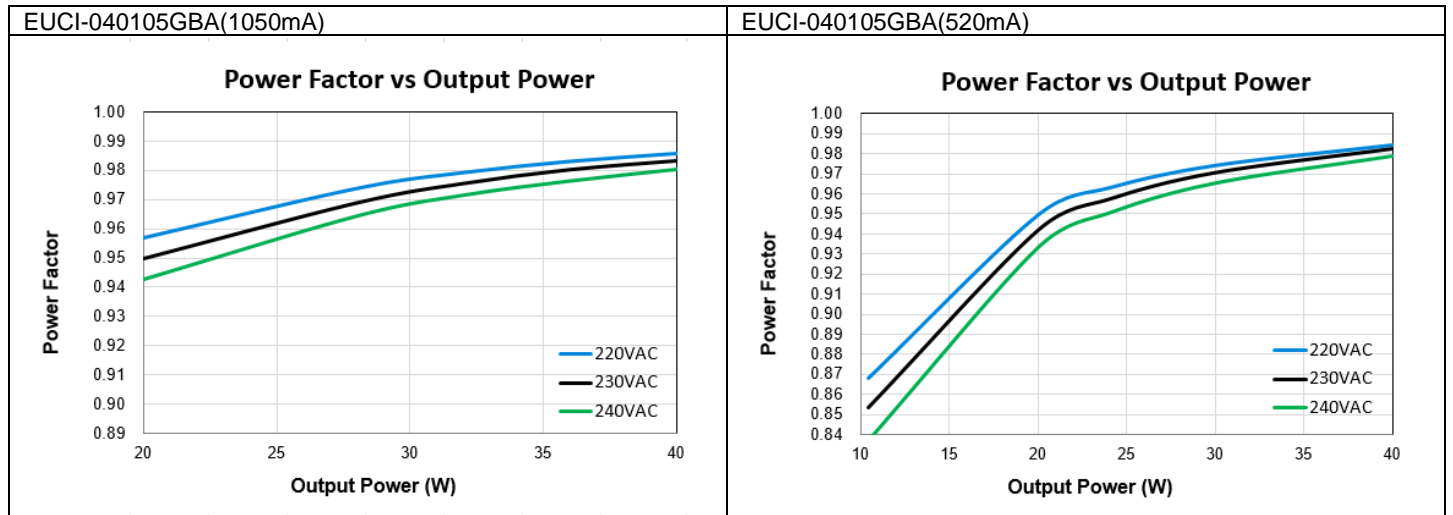

LED Driver

EUCI BASIC Series

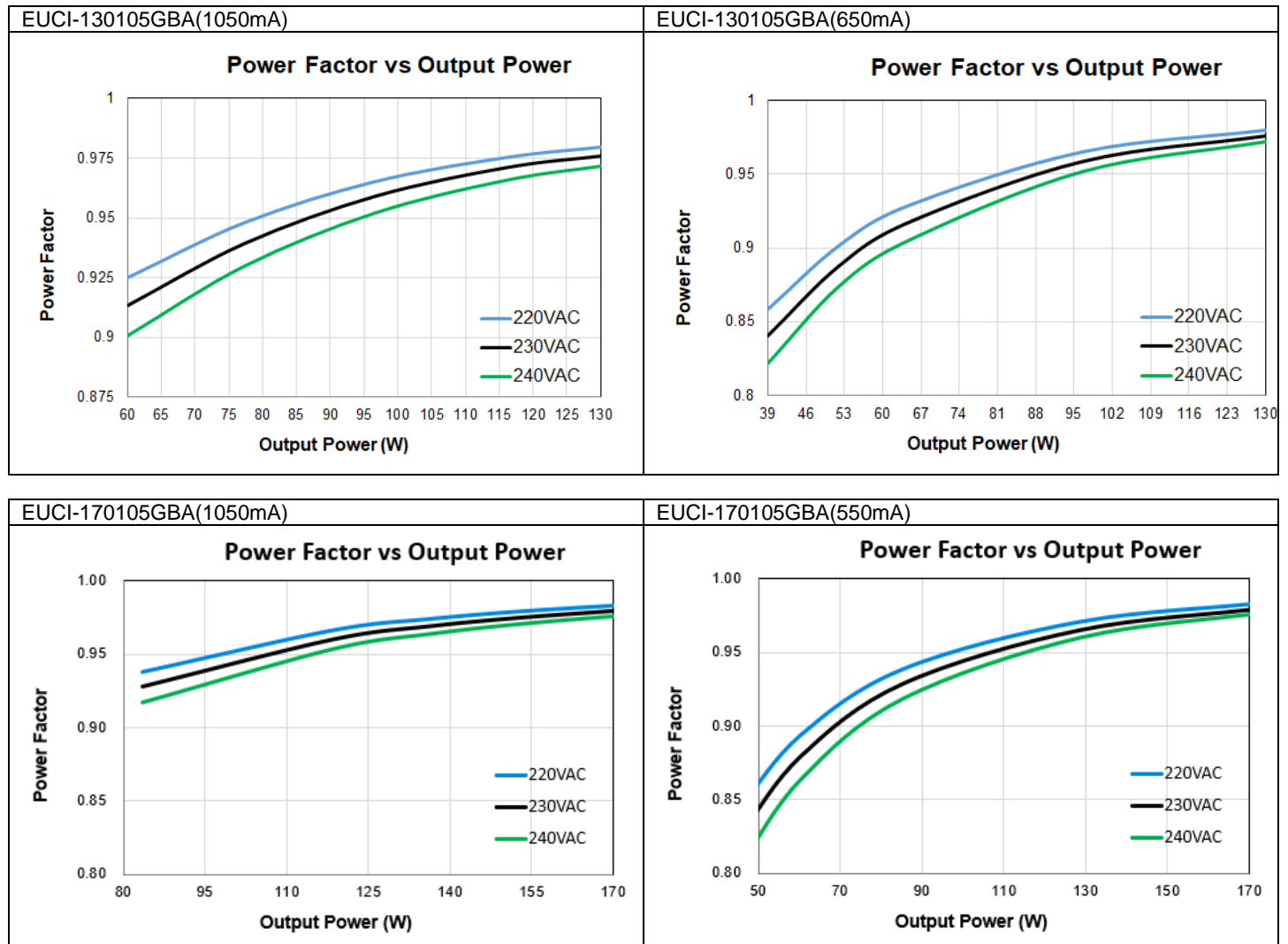

LED Driver

EUCI BASIC Series

Total Harmonic Distortion VS Output Power

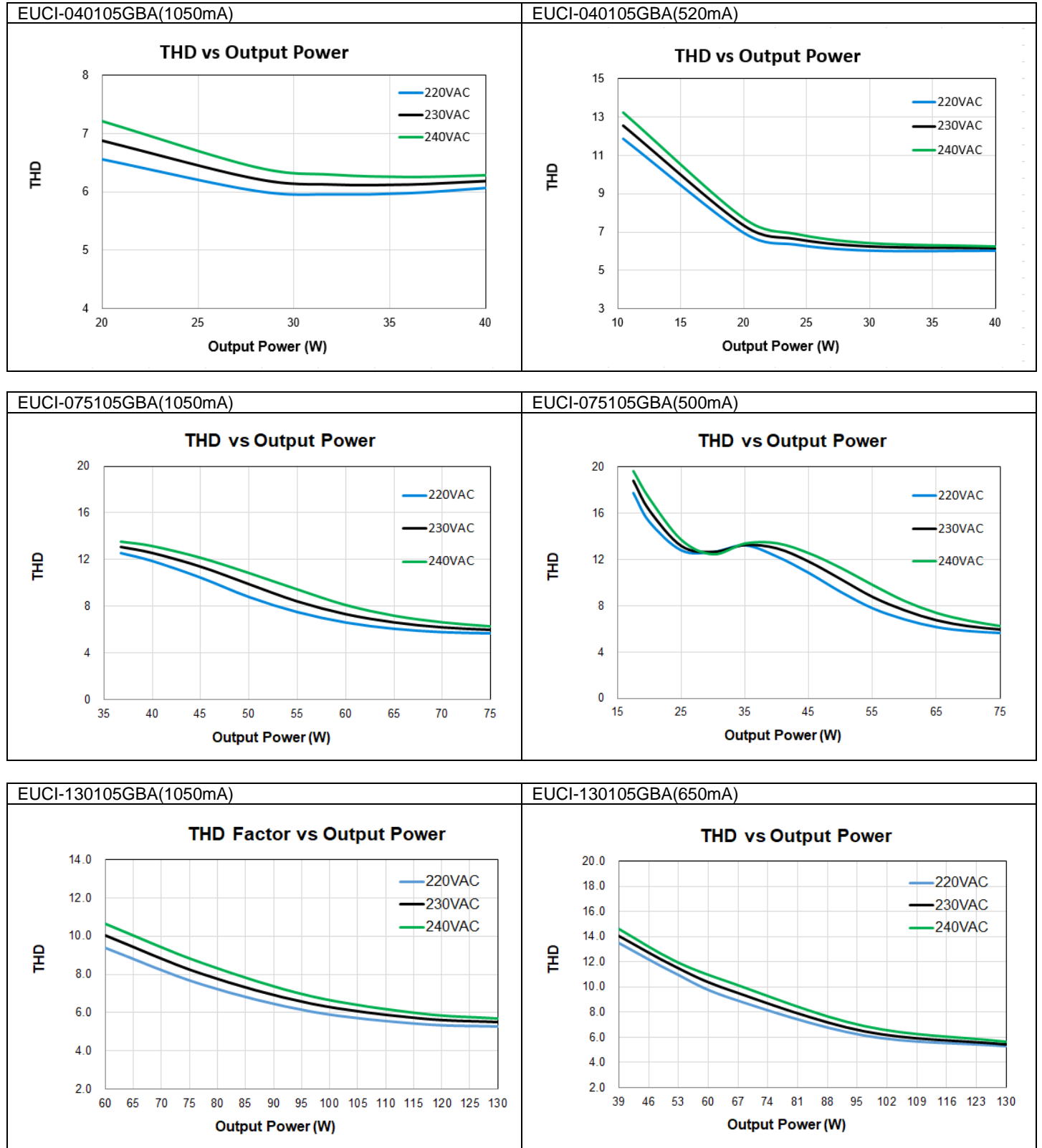

LED Driver

EUCI BASIC Series

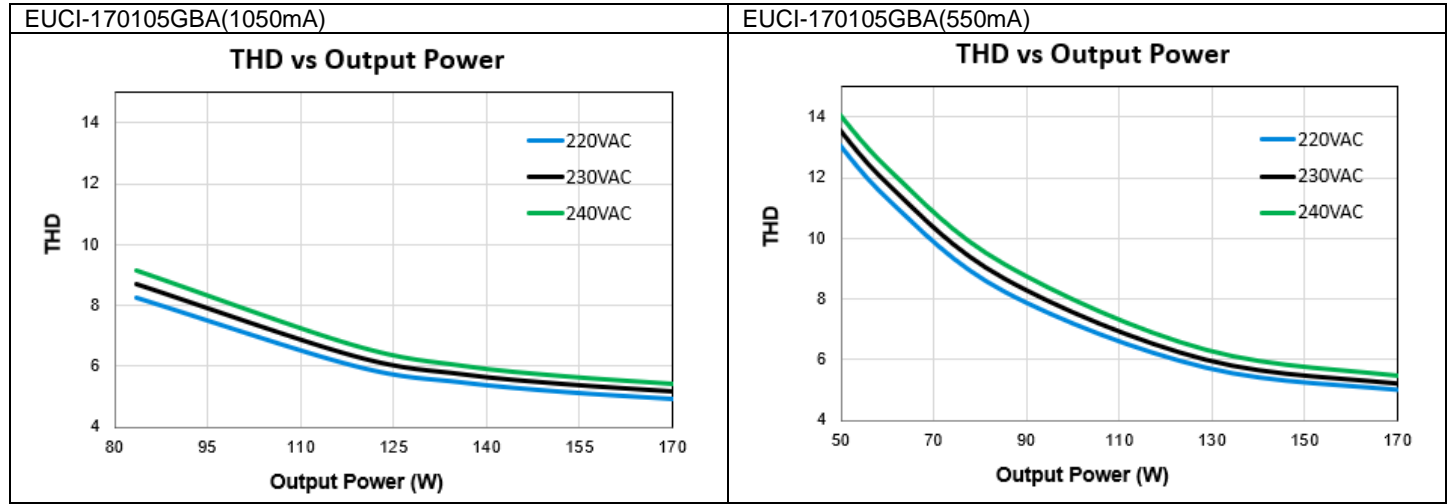

LED Driver

EUCI BASIC Series

Dimensions

EUCI-040105GBA & EUCI-075105GBA

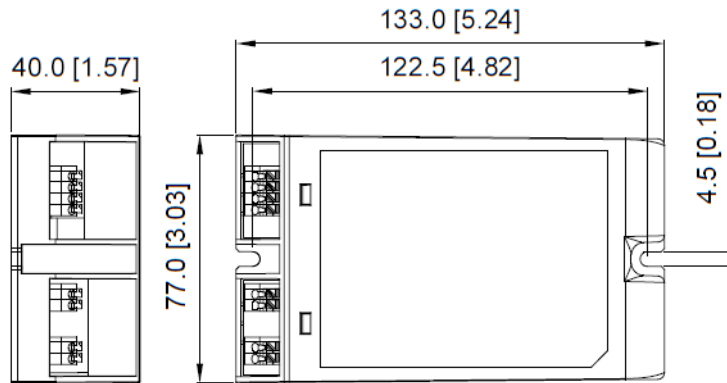

Unit: mm [inch]

EUCI-130105GBA

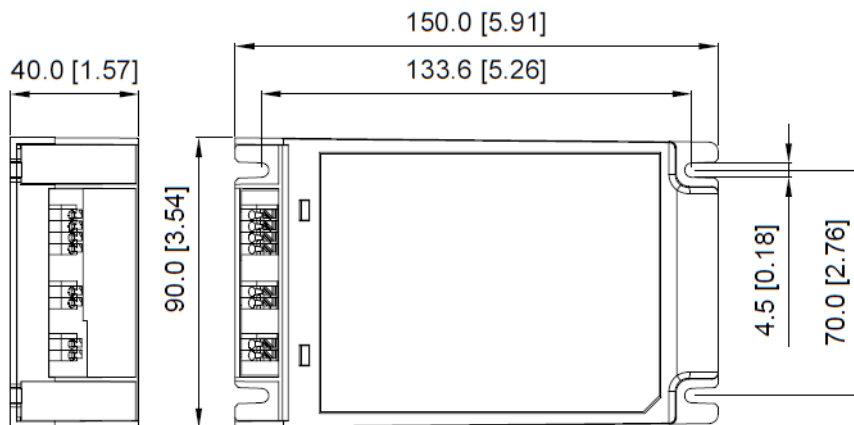

Unit: mm [inch]

EUCI-170105GBA

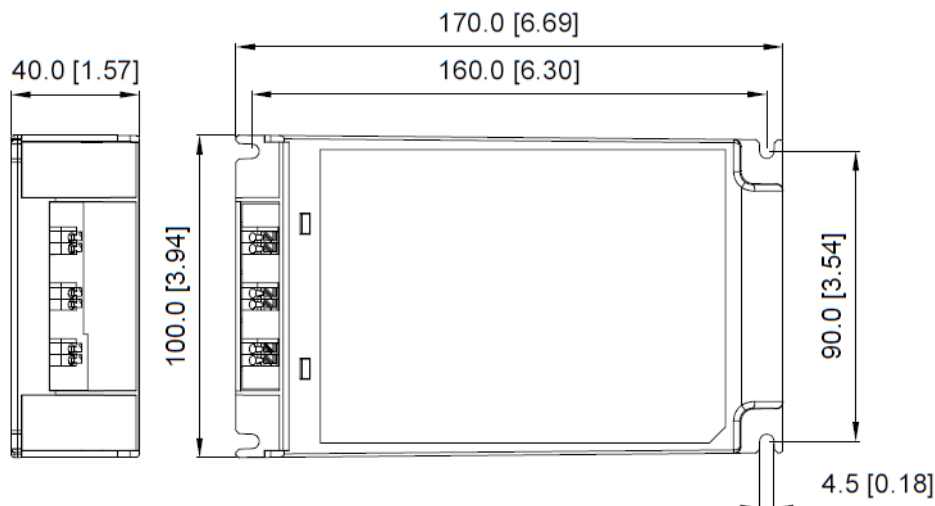

Unit: mm [inch]

LED Driver

EUCI BASIC Series

Smart Timer Dim Functions

Fixed Timer

It is a memoryless-based dimming mode that tracks the output level based on the programmed timing curve. The output level is organized by scheduled profile in five steps.

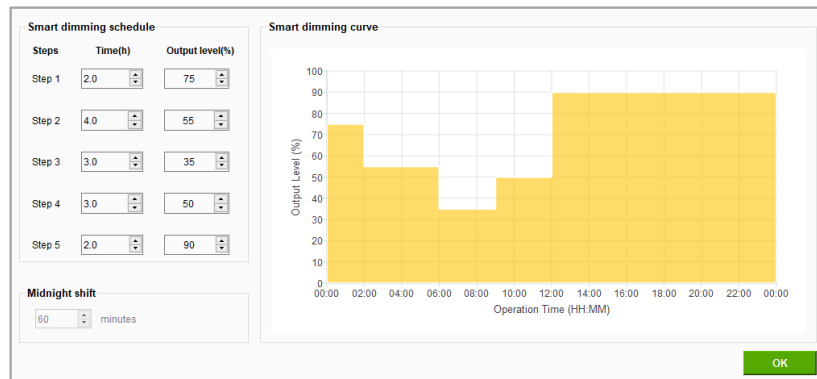

Midnight Centric Timer

This mode is a memory-based that automatically measures over the past two days the power-on time of the lighting installation at which is the naturally corresponded to night time. The Midnight Centric Timer software calculates the length of power on time and centralized from the given virtual midnight point and change the output level accordingly.

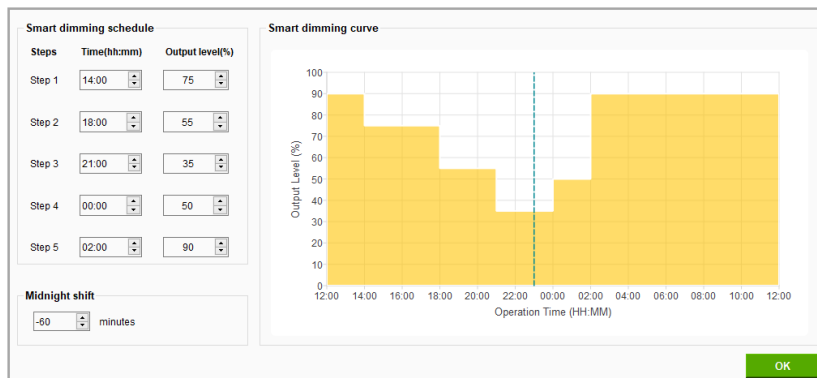

Ratio Rescale Timer

This mode is similar to Midnight Centric Timer that records the power-on time based on the local night time. The Ratio Rescale Timer software rescale programmed output power profile of each step by a calculated percentage of the recorded power-on time out of given 5 steps duration.

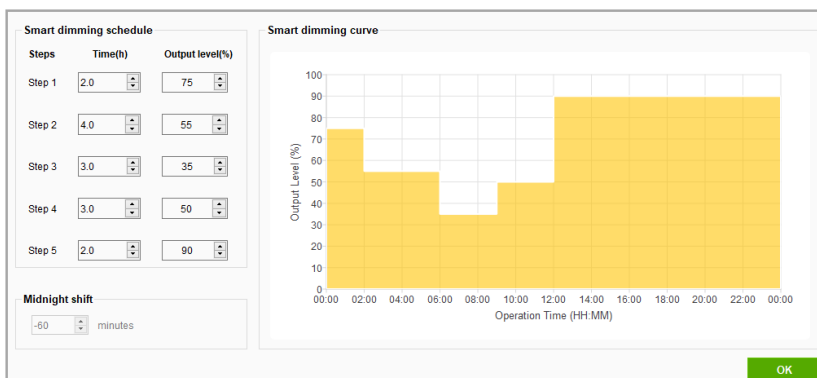

LED Driver

EUCI BASIC Series

Start-up Time

The time required for the output voltage to reach 90% of its final steady state set value, after the input voltage is applied.

Rise Time

The time required for the output voltage to change from 10% to 90% of its final steady state set value.

Hold-up Time

Time between the collapse of the AC input voltage, and the output falling to 95% of its steady state set value.

■ Graph illustrating the Start-up Time, Rise Time, and Hold-up Time

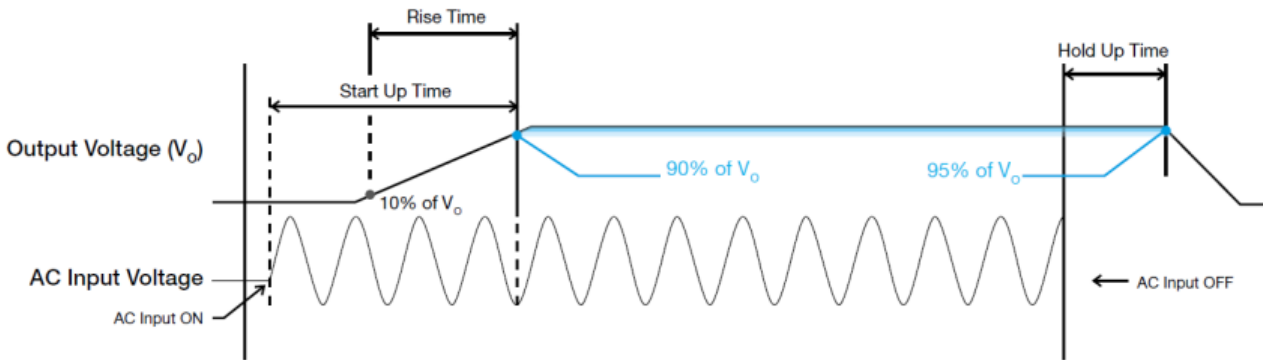

Inrush Current

Inrush current is the peak, instantaneous, input current measured and, occurs when the input voltage is first applied. For AC input voltages, the maximum peak value of inrush current will occur during the first half cycle of the applied AC voltage. This peak value decreases exponentially during subsequent cycles of AC voltage.

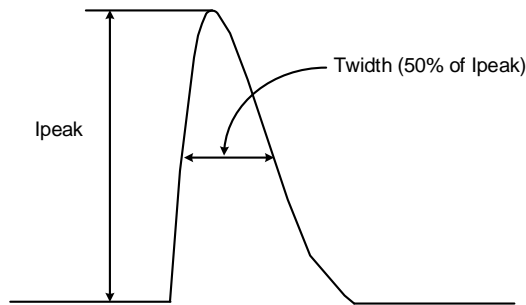

Wired Connection and NFC Program

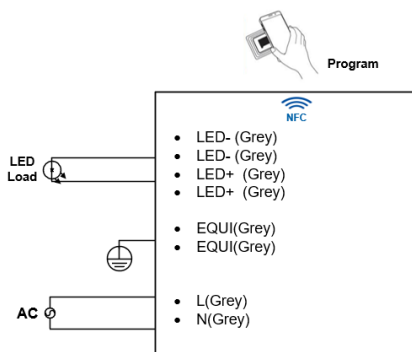

LED Driver

EUCI BASIC Series

Others and Protection

Delta RoHS Compliant



Restriction of the usage of hazardous substances

The European directive 2011/65/EU limits the maximum impurity level of homogeneous materials such as lead, mercury, cadmium, chrome, polybrominated flame retardants PBB and PBDE for the use in electrical and electronic equipment. RoHS is the abbreviation for “Restriction of the use of certain hazardous substances in electrical and electronic equipment”.

This product conforms to this standard.

PFC – Norm EN 61000-3-2

Line Current Harmonic content

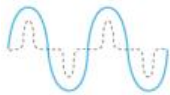

Typically, the input current waveform is not sinusoidal due to the periodical peak charging of the input capacitor. In industrial environment, complying with EN 61000-3-2 is only necessary under special conditions. Complying with this standard can have some technical drawbacks, such as lower efficiency as well as some commercial aspects such as higher purchasing costs. Frequently, the user does not profit from fulfilling this standard, therefore, it is important to know whether it is mandatory to meet this standard for a specific application.

Over Voltage Protections (Auto-Recovery)

The LED driver's Overvoltage Protections (OVP) will be activated when output voltage is achieved trigger point defined at OVP range. Upon such an occurrence, the I_o (output current) will start to droop.

Short Circuit Protection (Auto-Recovery)

The LED driver's output OLP function also provides protection against short circuits. When a short circuit is applied, the LED driver will operate in “hiccup mode”. It will return to normal operation after the short circuit is removed.

Overload & Overcurrent Protection (Auto-Recovery)

The LED driver's Overload (OLP) and Overcurrent (OCP) Protections will be activated when output is between 95% and 108% of I_o (max load). Upon such an occurrence, the V_o (output voltage) will start to droop. Once the LED driver has reached its maximum power limit, the protection will be activated; and, the LED driver will operate in “CC mode”. The LED driver will recover once the fault condition once the cause of OLP or OCP is removed, and I_o is back within the specified range.

Over Temperature Protection (Auto-Recovery)

As mentioned above, the LED driver also has Over Temperature Protection (OTP). In the event of a higher operating temperature at 100% load, the LED driver will run into OTP when the operating temperature is beyond what is recommended in the de-rating graph. When activated, the output voltage will go into bouncing mode until the temperature drops to its normal operating temperature as recommended in the de-rating graph.

Safety Instructions

- ALWAYS switch mains of input power OFF before connecting and disconnecting the input voltage to the device. If mains is not turned OFF, there is risk of explosion / severe damage.
- To guarantee sufficient convection cooling, keep a distance of 50mm above and lateral distance to other units.
- DO NOT insert any objects into the device.
- When the PE terminal is not connected, the device must be installed on a metal plate with PE connection.
- The current rating for the output cable must be rated higher than or equal to the output current of the power supply. Please refer to the product specifications.
- For device with dimming function, always ensure the dimming control is working properly. “Dimming 0-10V” shall be insulated from AC mains by reinforced insulation.

LED Driver

EUCI BASIC Series

Others

Warranty Policy

Please reach out our [Warranty Policy](#) should you require any further clarification.

Attention

Delta provides all information in the datasheets on an "AS IS" basis and does not offer any kind of warranty through the information for using the product. In the event of any discrepancy between the information in the catalog and datasheets, the datasheets shall prevail (please refer to www.DeltaPSU.com for the latest datasheets information). Delta shall have no liability of indemnification for any claim or action arising from any error for the provided information in the datasheets. Customer shall take its responsibility for evaluation of using the product before placing an order with Delta.

Delta reserves the right to make changes to the information described in the datasheets without notice.