

LED Driver

EUCI PREMIUM Series

EUCI PREMIUM



Benefits

- DALI 2 standard D4i certified LED-drivers
- Flexible and fully configuration via software GUI (DALI Interface, NFC)
- Dual integrated power supplies to power sensors directly from the driver
- Dimmable built-in constant current with a dimming range 5 – 100 %
- High-accuracy integrated power metering
- Extra energy savings through high efficiency and via multiple dimming options, including Corridor function

Features

- Integrated Bus Power Supply for sensors and radios (DALI part 250)
- Integrated 24VDC auxiliary power supply (DALI Part 150)
- Memory Bank 1 Extension / Luminaire Data (DALI part 251)
- Highly accurate energy reporting (DALI Part 252)
- Diagnostics & Maintenance data (DALI part 253)
- Easy to design-in with high surge protection - 10kV for luminaires of protection class I and class II
- Output current adjustable range: 200mA - 1050mA
- Midnight Centric Timer for autonomous dimming with five independent levels and fade time

Dimensions (L x W x H):

EUCI-022105GIA	133.0 x 77.0 x 40.0 mm (5.24 x 3.03 x 1.57 inch)
EUCI-040105GIA	133.0 x 77.0 x 40.0 mm (5.24 x 3.03 x 1.57 inch)
EUCI-075105GIA	133.0 x 77.0 x 40.0 mm (5.24 x 3.03 x 1.57 inch)
EUCI-130105GIA	150.0 x 90.0 x 40.0 mm (5.91 x 3.54 x 1.57 inch)
EUCI-170105GIA	170.0 x 100.0 x 40.0 mm (6.69 x 3.94 x 1.57 inch)

Safety Standards



General Description

Delta LED drivers come in different series to suit different application needs. The EUCI PREMIUM series features programmable output current level. EUCI PREMIUM series offers the capability to achieve different level of LED brightness via built-in DALI-2 function to meet various application and energy optimization needs. The products are designed and rigorously tested to work with various outdoor LED lighting conditions. Featuring high surge immunity (CM: 10kV, DM: 6kV) make Delta EUCI PREMIUM series an essential part of an energy efficient LED lighting power solution for both Industrial and outdoor applications. EUCI PREMIUM compliance DALI D4i certification (Part 250-253) and Part 150 for IoT luminaires.

LED Driver

EUCI PREMIUM Series

Model Information

EUCI PREMIUM LED Driver

Model Number	Input Voltage Range	Rated Output Voltage	Programmable Output Current	Constant Power Current
EUCI-022105GIA	220-240Vac Typical 198-264Vac Range	8-48Vdc	200-1050mA	460-1050mA
EUCI-040105GIA		20-77Vdc	200-1050mA	520-1050mA
EUCI-075105GIA		35-150Vdc	200-1050mA	500-1050mA
EUCI-130105GIA		60-200Vdc	200-1050mA	650-1050mA
EUCI-170105GIA		80-310Vdc	200-1050mA	550-1050mA

Model Numbering

EU	C	I	-	□□□	□□□	G	I	A
Safety Approval CE, ENEC	Constant current	Industrial		Output Power 022–22W 040–40W 075–75W 130–130W 170–170W	Output Current 200–1050mA	Programmable output current	Control type DALI-2 + D4i	Standard code

LED Driver

EUCI PREMIUM Series

Specifications

Model Number	EUCI-022105GIA	EUCI-040105GIA	EUCI-075105GIA	EUCI-130105GIA	EUCI-170105GIA
--------------	----------------	----------------	----------------	----------------	----------------

Input Ratings / Characteristics

Normal Input Voltage	220-240Vac					
Input Voltage Range	198-264Vac					
Normal Input Frequency	50-60Hz					
Input Frequency Range	47-63Hz					
Max. Input Current	230Vac	0.13A	0.23A	0.41A	0.70A	0.87A
Efficiency ¹⁾	230Vac	87% @ 0.46A	89.5% @ 0.52 A	91% @ 0.5 A	93% @ 0.65 A	93.5% @ 0.55 A
	230Vac	84% @ 1.05A	86.5% @ 1.05A	89.5% @ 1.05A	92% @ 1.05A	92.5% @ 1.05A
Inrush Current (Apk / 50%-us) (Cold Start)	230Vac	50A/180uS			70A/200uS	70A/200uS
Max. No. of LED Drivers circuit breaker @ 230Vac	B10	18pcs		16pcs	6pcs	6pcs
	B16	28pcs		26pcs	10pcs	10pcs
	C10	30pcs		16pcs	10pcs	8pcs
	C16	46pcs		26pcs	16pcs	12pcs
Power Factor	> 0.95 @ 230Vac, 100% load and > 0.90 @230Vac, 50% load					
Total Harmonic Distortion	THD < 20% with load ≥ 50% @ 230Vac					
Touch Current	< 0.7mA peak @ 230Vac					
Standby Power ²⁾	0.5W @ DALI standby mode, 230Vac					
Input Over-Voltage	Can survive input over-voltage stress of 320VAC for 48 hours and 350Vac for 2 hours					

- 1) 100% Load (typical) and tested after 30 minutes warm up
 2) without load@24Vaux power and control bus

Output Ratings / Characteristics

Output Voltage Range	8-48Vdc	20-77Vdc	35-150Vdc	60-200Vdc	80-310Vdc
Max. No Load Output Voltage	90V	120V	210V	280V	400V
Output Power Range	22W	40W	75W	130W	170W
Adjustable Output Current (AOC)	200-1050mA	200-1050mA	200-1050mA	200-1050mA	200-1050mA
	With steps of 1mA, configurable via software				
Physical Minimum Output Current	35mA (Min dim level)				
Current Accuracy	+/-5%@ (0.46A~1.05A)	+/-5%@ (0.52A~1.05A)	+/-5%@ (0.5A~1.05A)	+/-5%@ (0.65A~1.05A)	+/-5%@ (0.55A~1.05A)
Output Current LF Ripple	4% (ripple = peak-average/average) at 100% load, (<100Hz) 130w/170w at max. output current				
Start-up Time	520~1000ms max. (@ 220-240Vac)				

Environment

Ambient Temperature	Operating	-40°C to +55°C			
	Storage	-40°C to +85°C			
Maximum Case Temperature	+85°C	+90°C	+90°C	+90°C	+90°C
Lifetime @ tc	+85°C	+90°C	+90°C	+90°C	+90°C
Relative Humidity	Operating	10 to 90% RH (Non-Condensing)			
	Storage	5 to 95% RH (Non-Condensing)			

LED Driver

EUCI PREMIUM Series

Model Number	EUCI-022105GIA	EUCI-040105GIA	EUCI-075105GIA	EUCI-130105GIA	EUCI-170105GIA
--------------	----------------	----------------	----------------	----------------	----------------

Aux. Power 24VDC Characteristics (DALI part 150)

Operating voltage range	21.6V-26.4V (0.1 W ≤ PLoad ≤ 6.0 W; Including load steps)
High frequency ripple	<1Vp-p (frequency of ripple > 10 kHz)
No load voltage range	30V (@ Pload <0.1W)
Average output power	3W (21.6 V ≤ VAux ≤ 26.4 V; averaging period ≥ 6 ms)
Pulsed output power	6W (21.6 V ≤ VAux ≤ 26.4 V; tpulse ≤ 2.2 ms; repetitive)
Start-up time	0.6S_max (VAux to reach 21.6 V; ILoad ≤ 0.16 A; Mains applied at any phase angle)
Supply interruption time	10mS_typical (21.6 V ≤ VAux ≤ 26.4 V, Average output power ≤ PLoad_avg , Pulsed output power ≤ PLoad_pk)

Integrated DALI power (DALI part 250)

Voltage range	22.5V_max
Current range	60mA_max

Mechanical

Casing	Plastic, Color : Black			
Dimensions (L x W x H)	[mm]	133.0 x 77.0 x 40.0	150.0 x 90.0 x 40.0	170.0 x 100.0 x 40.0
	[inch]	5.24 x 3.03 x 1.57	5.91 x 3.54 x 1.57	6.69 x 3.94 x 1.57
Unit Weight	[kg]	0.57	0.72	0.99
	[lb]	1.26	1.59	2.18
Pieces per carton box		20pcs	12pcs	10pcs
Weight/carton	[kg]	12	9.14	10.4
Cooling System	Convection			
Input connector :	For 22/40/75W, Terminal, 5-pole, with push-button, Conductor 0.5~2.5 mm ² , Strip length 10...11mm Line : Black, Neutral : White, Space*2 : Gray, EUQI : Green			
	For 130/170W Terminal, 3-pole, with push-button, Conductor 0.5~2.5 mm ² , Strip length 10...11mm Line : Black, Neutral : White, Space: Gray			
Output and control connector	For 22/40/75W, Terminal, 7-pole, with push-button, Conductor 0.5~1.5 mm ² , Strip length 8.5...9.5mm Output : LED+ : Red, LED- : Black, MTP+ : Light blue, MTP- : White Control : +24V : Red, DA+ : Pink, DA-/GND : Gray			
	For 130/170W Terminal, 11-pole, with push-button, Conductor 0.5~1.5 mm ² , Strip length 8.5...9.5mm Output : Space: Gray, EQUI: Green, Space*2: Gray, LED+ : Red, LED- : Black, MTP+ : Light blue, MTP- : White Control : +24V : Red, DA+ : Pink, DA-/GND : Gray			
Max cable length	2m (between driver and LED module)			
Noise (30cm distance)	Sound Pressure Level (SPL) < 24dBA			

LED Driver

EUCI PREMIUM Series

Model Number	EUCI-022105GIA	EUCI-040105GIA	EUCI-075105GIA	EUCI-130105GIA	EUCI-170105GIA
--------------	----------------	----------------	----------------	----------------	----------------

Protections

Over Voltage	90Vrms	120Vrms	210Vrms	280Vrms	400Vrms
	LED driver will work normally when the fault is removed				
Overload / Overcurrent	Reduce output current. Auto-Recovery when the fault is removed				
Short Circuit	Auto-Recovery when the fault is removed				
Over Temperature	Reduce output current. Auto-Recovery when the fault is removed				
Ingress Protection Classification	IP20				
Suitable for Luminaires Class	Class I/Class II. Insulation Class according to IEC 60598				

Reliability Data

Lifetime	100,000hours @ Maximum Case Temperature -10deg 50,000 hours @ Maximum Case Temperature (lifetime case temperature)
MTTF	1000,000 hours for 22W/40W 475,000 hours for 75W/130W/170W @Ta=+55°C (as per Telcordia SR-332, total failure rate less than 10%)

Safety Standards / Directives

Electrical Safety	IEC 61347-1, IEC 61347-2-13 (Built in) EN 61347-1, EN 61347-2-13 SELV (for 22W/40W) ENEC, UKCA
CE	In conformance with EMC Directive and Low Voltage Directive
Material and Parts	RoHS Directive 2019/65/EU Compliant

Insulation

Insulation				
22W/40W	Mains	EQUI	LED+MTP	DALI+24Vaux
Mains	N/A	Double	SELV	SELV
EQUI	Double	N/A	Supplementary	Supplementary
LED+MTP	SELV	Supplementary	N/A	Supplementary
DALI + 24Vaux	SELV	Supplementary	Supplementary	N/A

Insulation				
75W	Mains	EQUI	LED+MTP	DALI+24Vaux
Mains	N/A	Double	Double	Double
EQUI	Double	N/A	Basic	Supplementary
LED+MTP	Double	Basic	N/A	Supplementary
DALI + 24Vaux	Double	Supplementary	Supplementary	N/A

Insulation				
130/170W	Mains	EQUI	LED+MTP	DALI+24Vaux
Mains	N/A	Double	Double	Double
EQUI	Double	N/A	Basic	Supplementary
LED+MTP	Double	Basic	N/A	Supplementary
DALI + 24Vaux	Double	Supplementary	Supplementary	N/A

LED Driver

EUCI PREMIUM Series

Model Number	EUCI-022105GIA	EUCI-040105GIA	EUCI-075105GIA	EUCI-130105GIA	EUCI-170105GIA
---------------------	----------------	----------------	----------------	----------------	----------------

EMC

Emissions (CE & RE)	Compliance to EN 55015 Class B;				
Immunity	Compliance to EN 61547				
Electrostatic Discharge	IEC 61000-4-2	Air Discharge: 8kV Contact Discharge: 4kV Criteria A ¹⁾ or Criteria B ²⁾			
Radiated Disturbances	IEC 61000-4-3	80MHz-1GHz, 3V/m with 1kHz Sine Wave / 80% Modulation Criteria A ¹⁾			
Electrical Fast Transient / Burst	IEC 61000-4-4	1KV, Criteria A ¹⁾ or Criteria B ²⁾			
Surge	IEC 61000-4-5	Common Mode ³⁾ : 10kV; Differential Mode ⁴⁾ : 6kV, Criteria A ¹⁾ or Criteria B ²⁾			
Conducted Disturbances	IEC 61000-4-6	150kHz-80MHz, 3Vrms ,Criteria A ¹⁾			
Power Frequency Magnetic Fields	IEC 61000-4-8	3A/Meter, Criteria A ¹⁾			
Voltage Dips	IEC 61000-4-11	100% dip; 0.5 cycle, Criteria A ¹⁾ or Criteria B ²⁾ 30% dip; 10 cycle, Criteria A ¹⁾ or Criteria B ²⁾			
Harmonic Current Emission	IEC 61000-3-2	Class C (230Vac @ ≥ 50% load)			
Voltage Fluctuation & Flicker	IEC 61000-3-3				

1) Criteria A: Normal performance within the specification limits

2) Criteria B: Temporary degradation or loss of function, which is self-recoverable

3) Asymmetrical: Common mode (Line to earth: 12ohm)

4) Symmetrical: Differential mode (Line to line: 2ohm)

Default Settings of the Driver (can be configured with programming tool)

Adjustable Output Current (AOC)	460mA	520mA	500mA	650mA	550mA
Smart Timer DIM	Disabled. Configurable though programming tool				
Module Temperature Protection (MTP)	Disabled. Configurable though programming tool				
Constant Lumen Output (CLO)	Disabled. Configurable though programming tool				
End of Life indication (EOL)	Disabled. Configurable though programming tool				
Auxiliary Output	Enabled				

DALI Specification

Dimming range	5-100% duty
Standards	EN 62386-101 EN 62386-102 EN 62386-207 D4i: DALI Part 150 , DALI Part 250-253 (Typical accuracy of Part 252: +/-2% at 100% Load)

LED Driver

EUCI PREMIUM Series

Lifetime VS Case Temperature

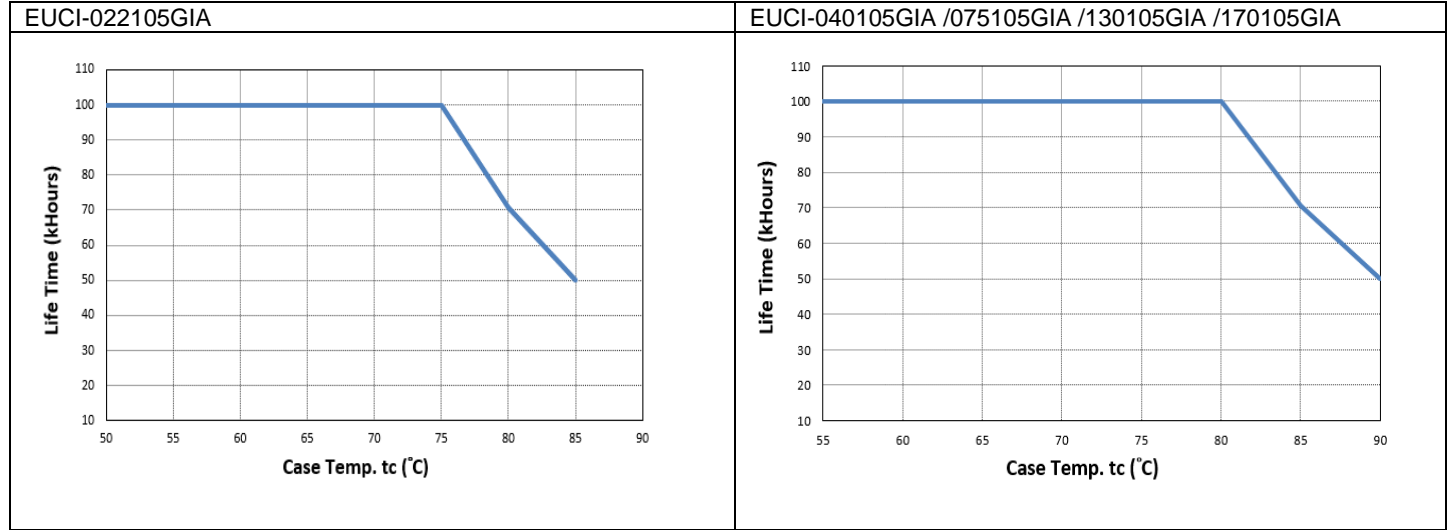

LED Driver

EUCI PREMIUM Series

Output and Dimming Characteristic Curve

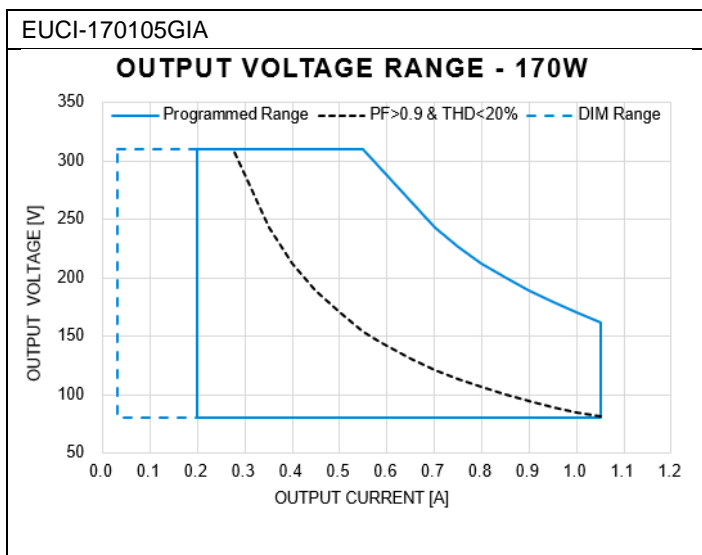
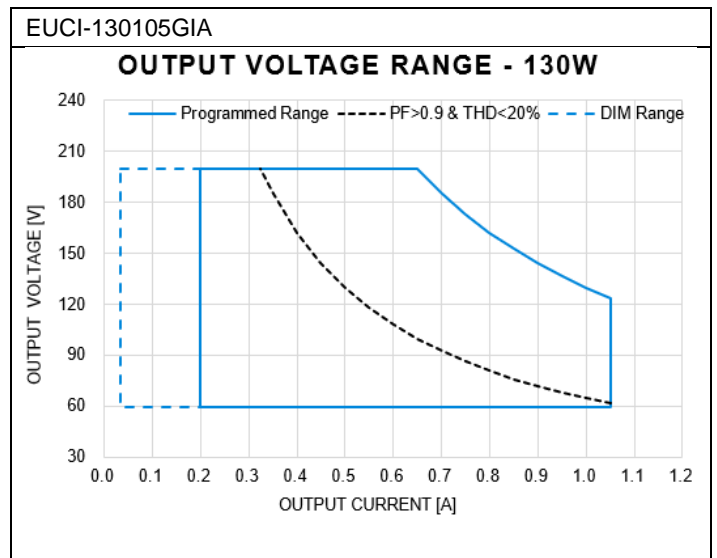
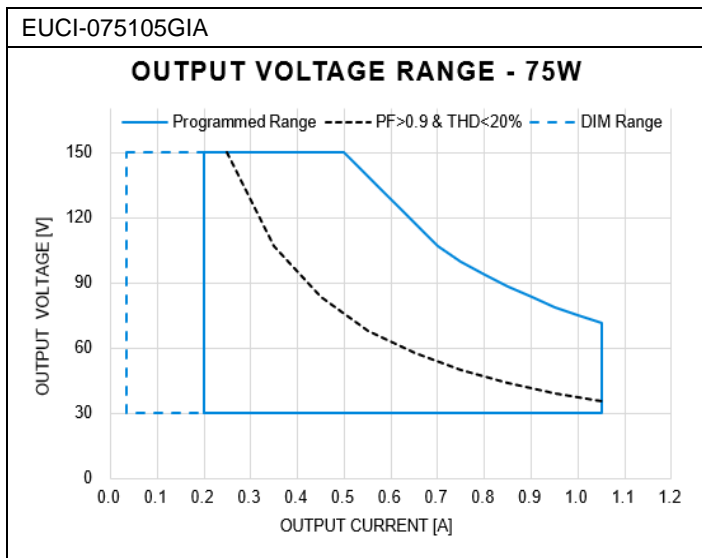
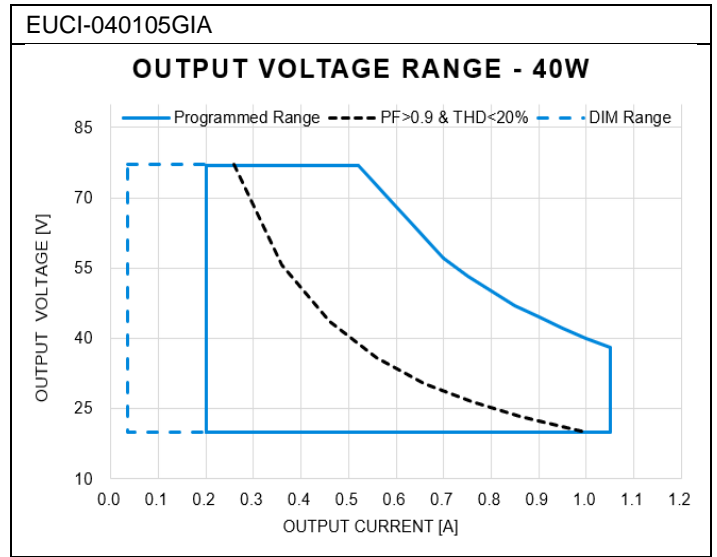
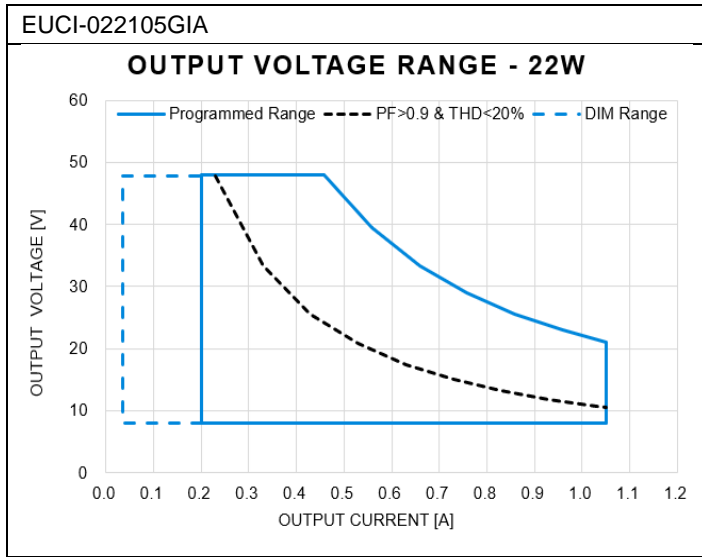

LED Driver

EUCI PREMIUM Series

Efficiency VS Output Power

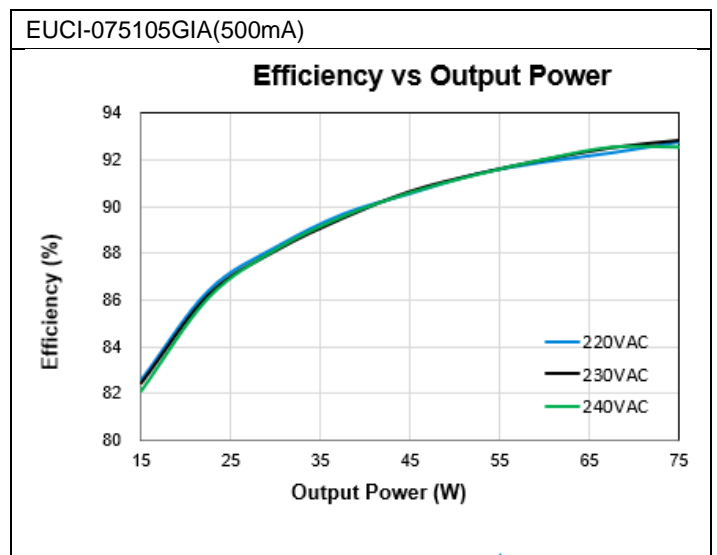
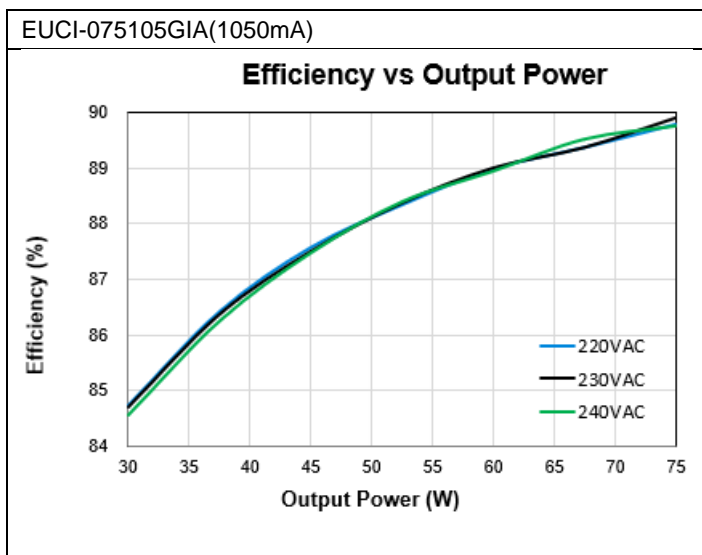
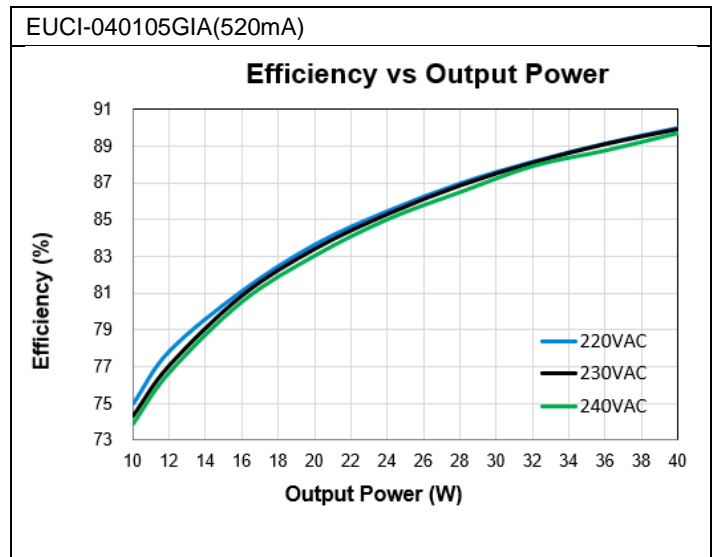
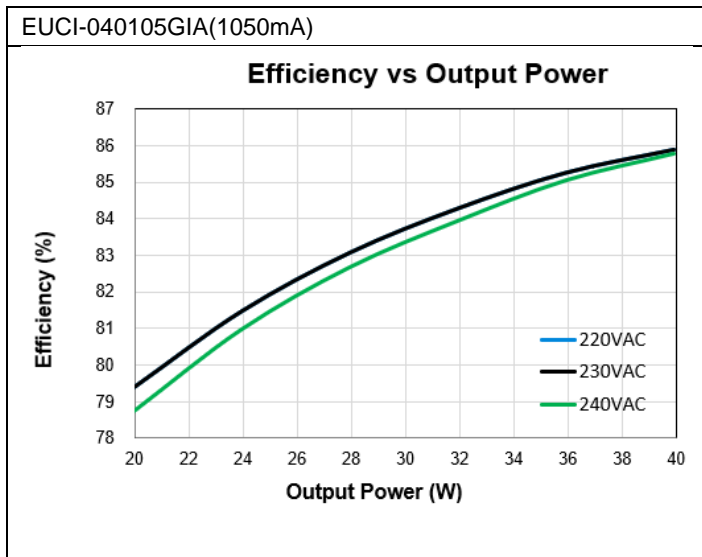
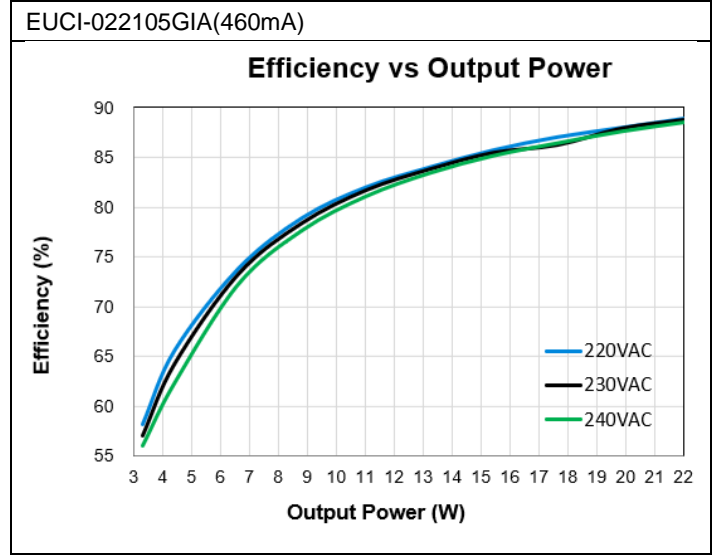
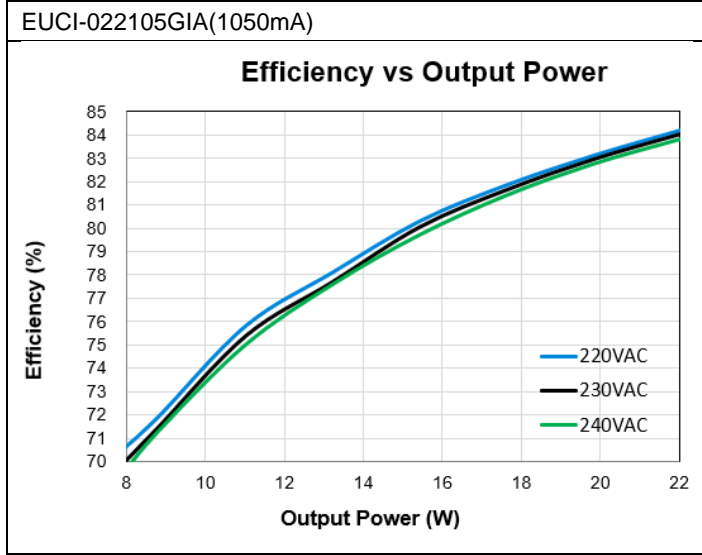

LED Driver

EUCI PREMIUM Series

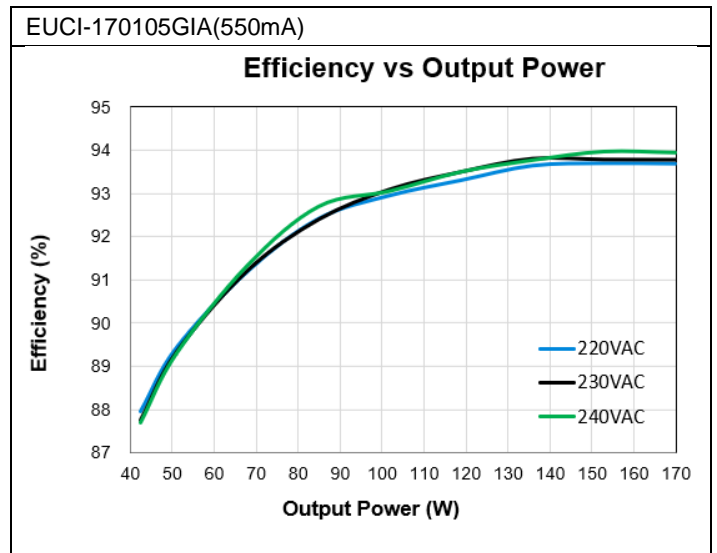
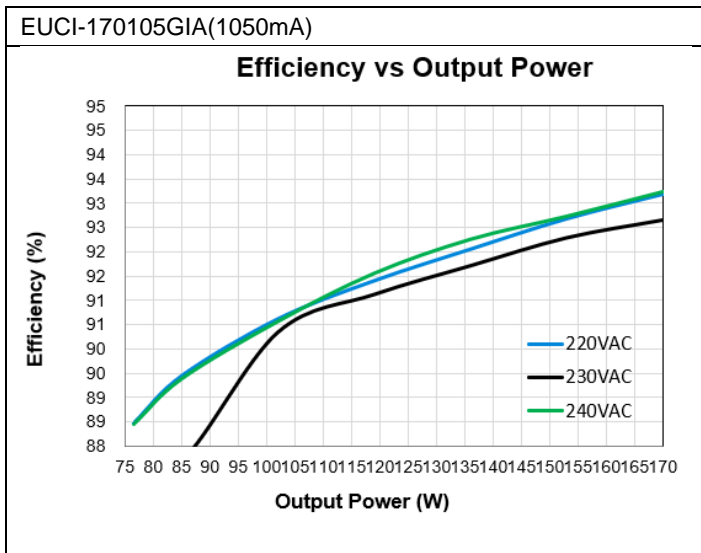
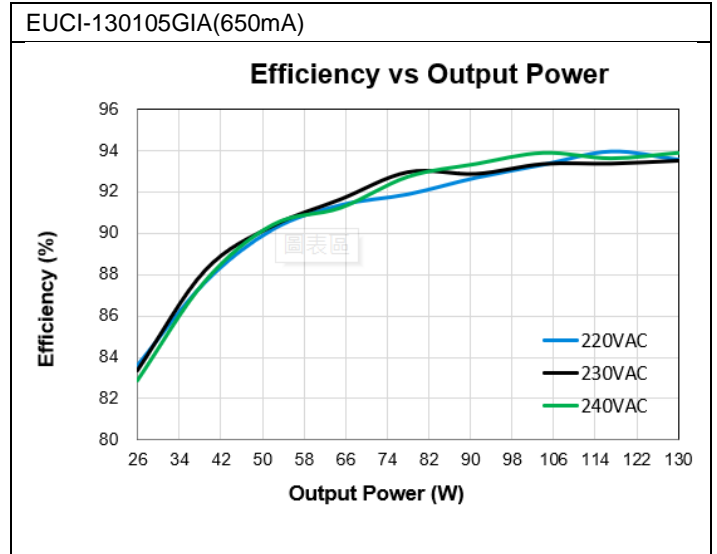
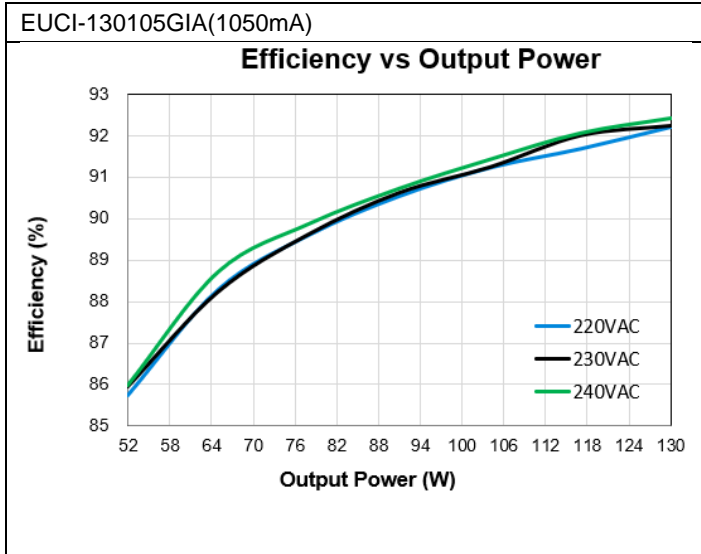

LED Driver

EUCI PREMIUM Series

Power Factor VS Output Power

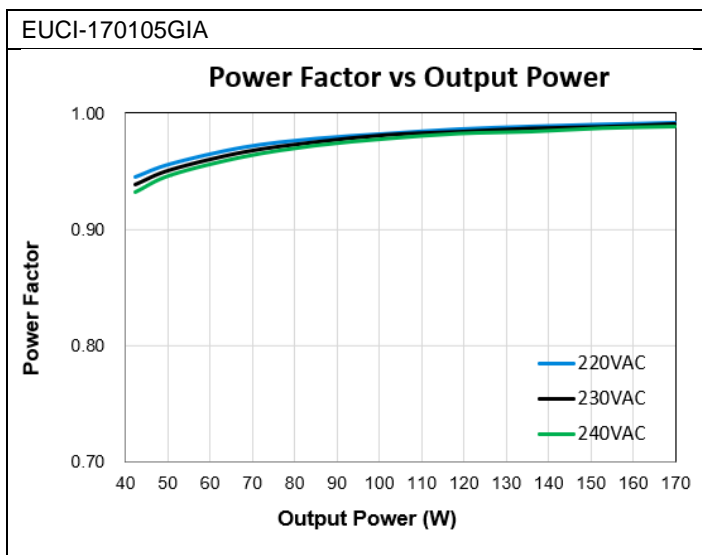
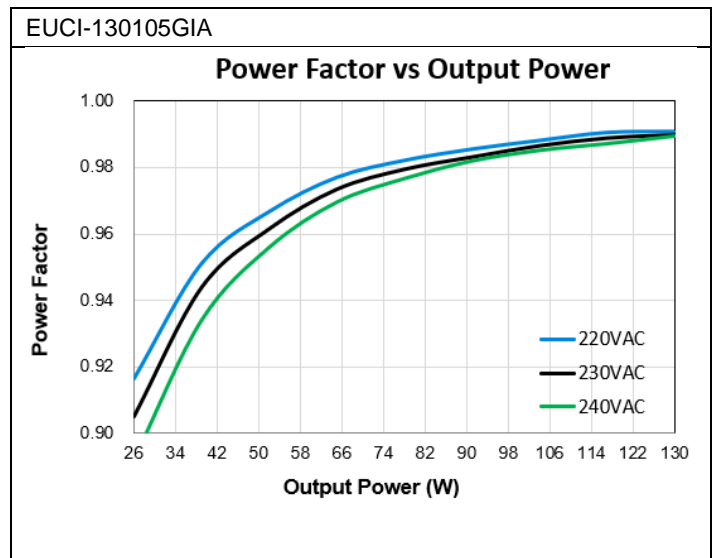
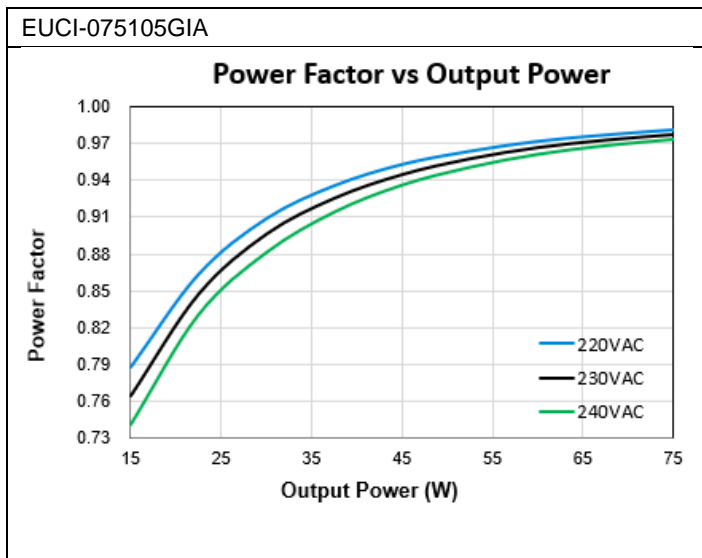
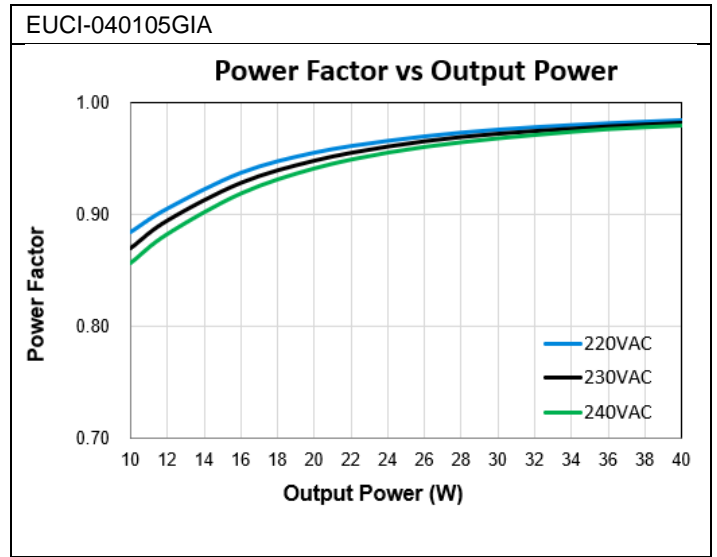
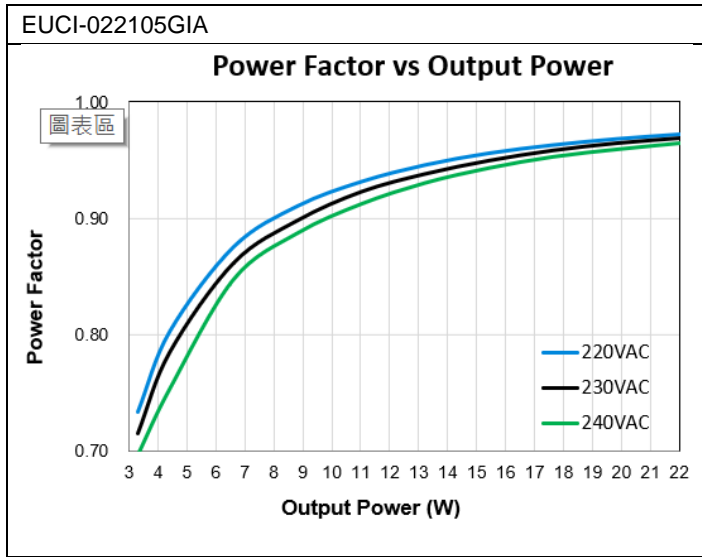

LED Driver

EUCI PREMIUM Series

Total Harmonic Distortion VS Output Power

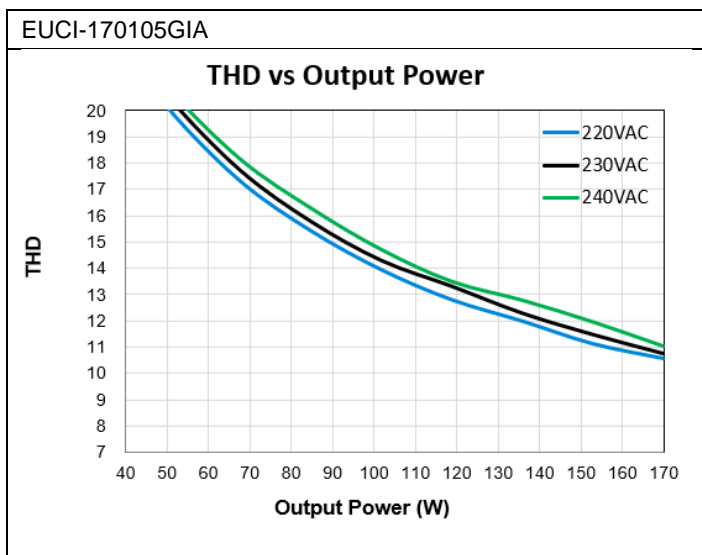
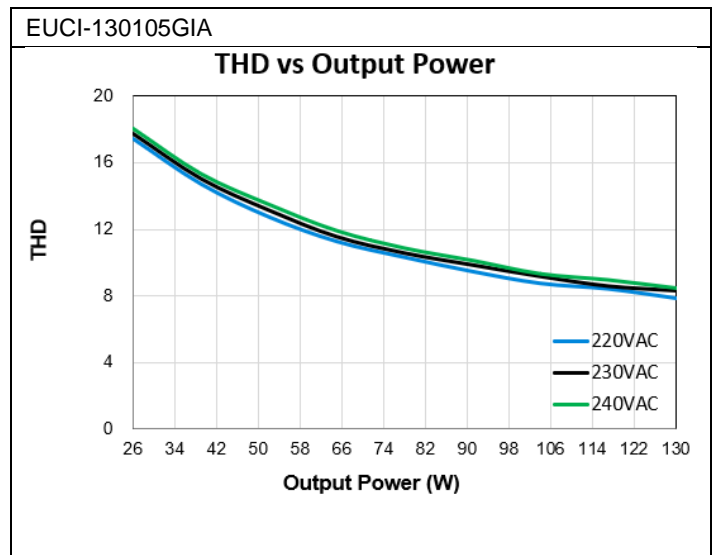
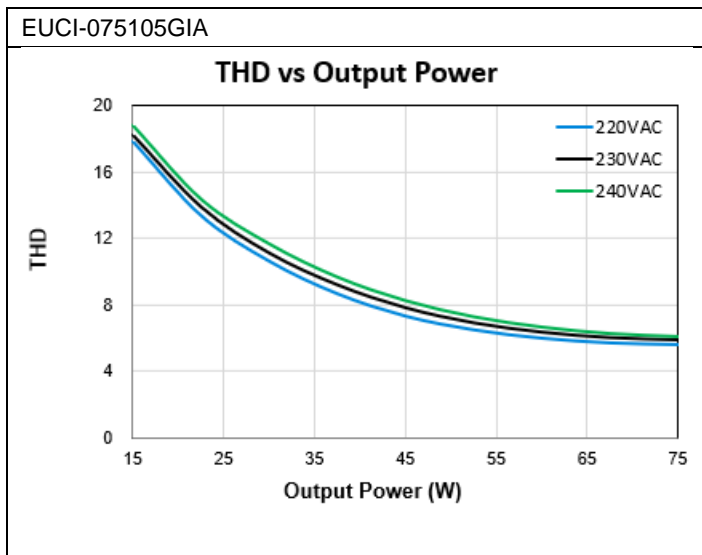
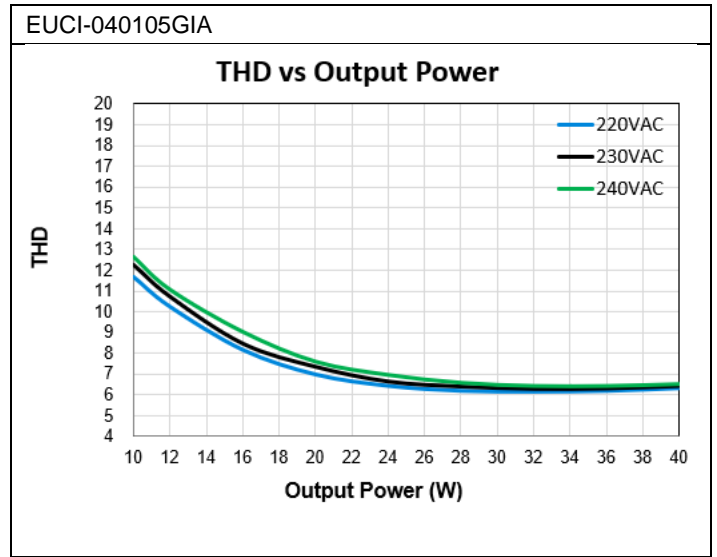
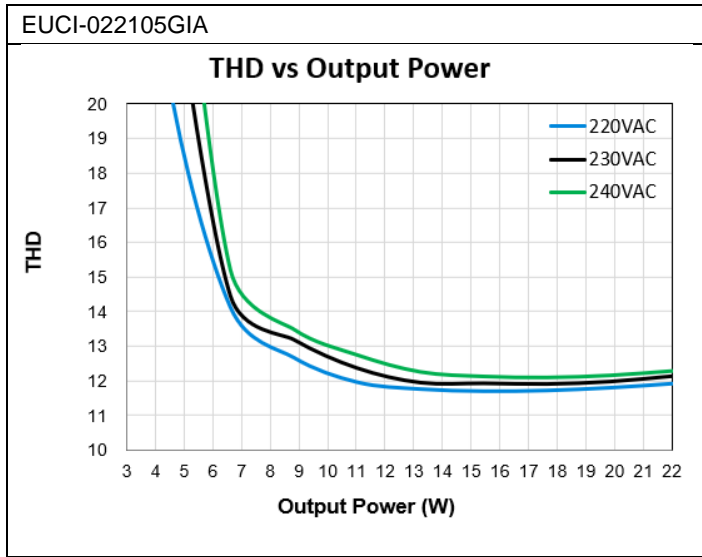

LED Driver

EUCI PREMIUM Series

Dimensions

EUCI-022105GIA & EUCI-040105GIA & EUCI-075105GIA

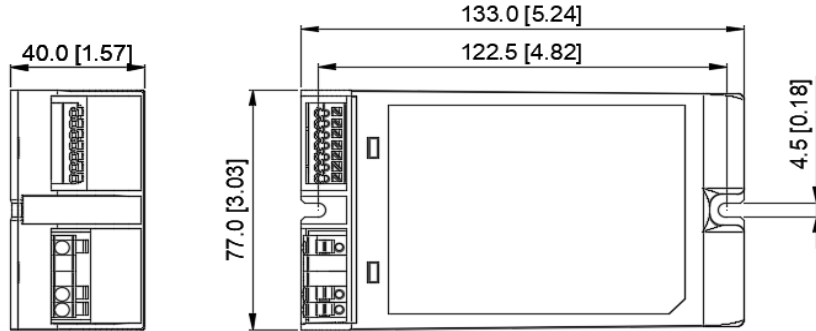

Unit: mm [inch]

EUCI-130105GIA

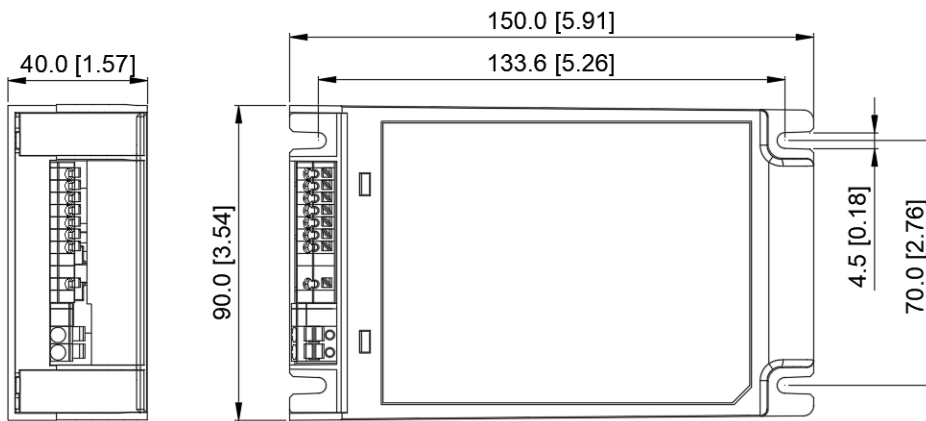

Unit: mm [inch]

EUCI-170105GIA

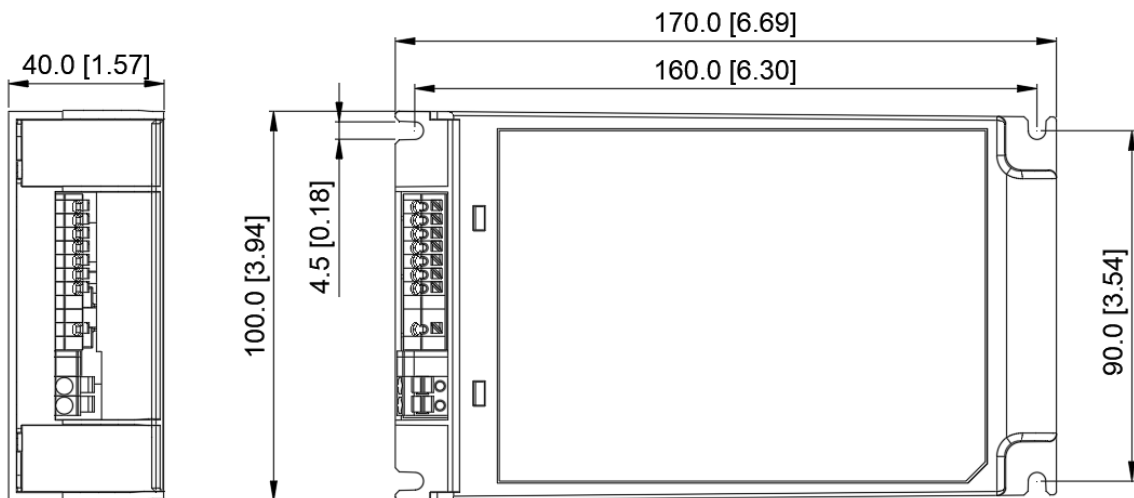

Unit: mm [inch]

LED Driver

EUCI PREMIUM Series

Functions

Corridor Mode

Corridor Mode is operated with DALI input device, the LED output is adjusted to a defined level when a presence sensor detects a movement object in the range then hold at define level for a certain time before go to a defined background level when presence sensor is released as the movement object is no longer in the detection range. The operation is illustrated as shown below

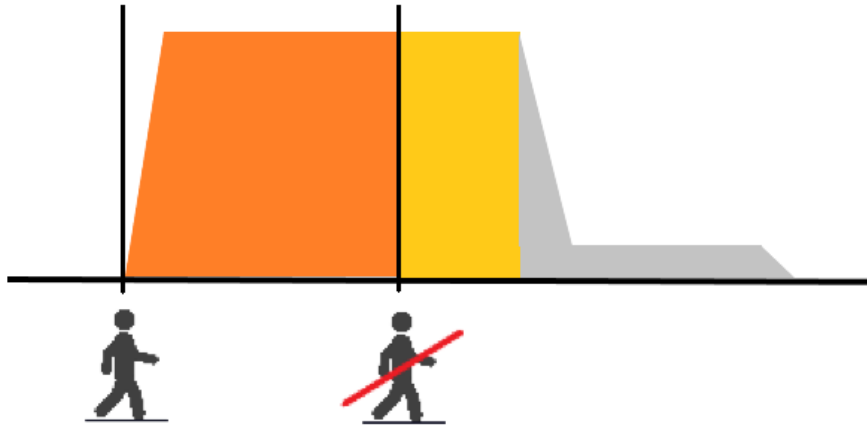

Smart Timer Dim

Provides three operation modes: Fixed Timer, Midnight Centric Timer, Ratio Rescale Timer.

Fixed Timer

It is a memoryless-based dimming mode that tracks the output level based on the programmed timing curve. The output level is organized by scheduled profile in five steps.

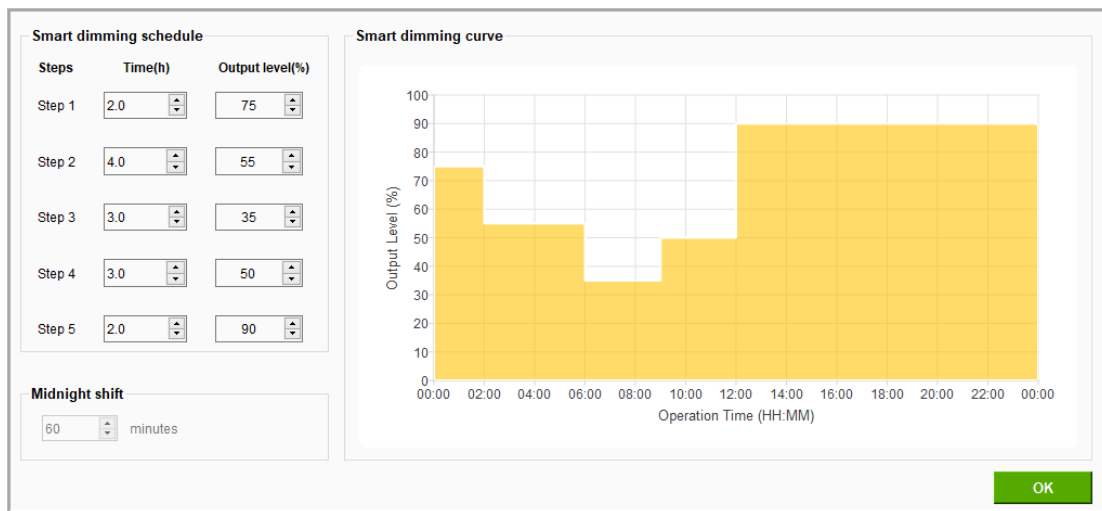

LED Driver

EUCI PREMIUM Series

Midnight Centric Timer

This mode is an memory-based that automatically measures over the past two days the power-on time of the lighting installation at which is the naturally corresponded to night time. The Midnight Centric Timer software calculates the length of power on time and centralized from the given virtual midnight point and change the output level accordingly. More specifically, when the LED driver is power-on during the very first two days or the power-on time difference of past two days is more than 15 minutes, the output current will fixed to the maximum level since there is no valid (reasonable) data for reference. Start from the third day and so on, when the power-on time difference of past two days is less than 15 minutes, the output level is controlled based on the correlation between the midnight point of programmed profile and yesterday power-on duration.

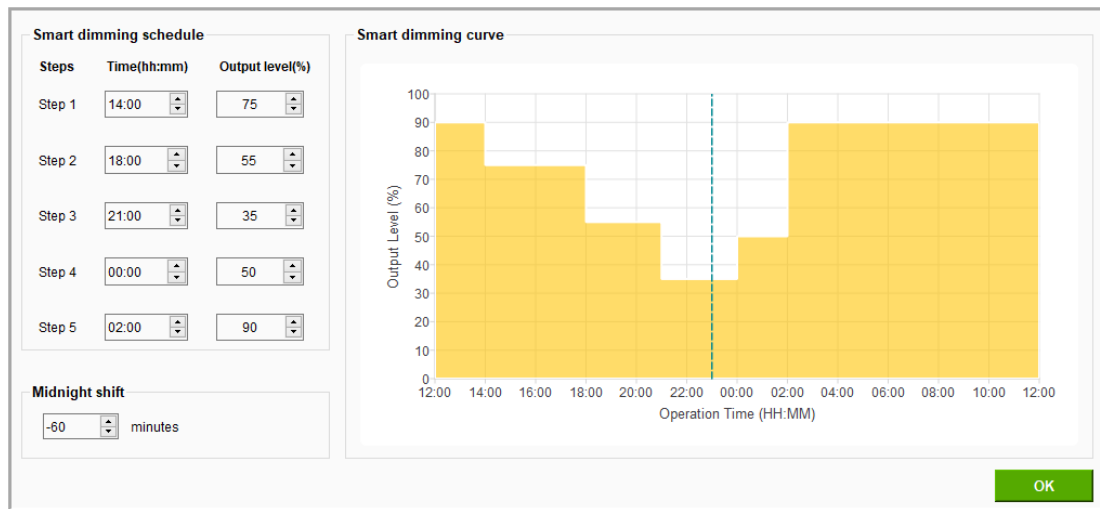

Ratio Rescale Timer

This mode is similar to Midnight Centric Timer that records the power-on time based on the local night time. The Ratio Rescale Timer software rescale programmed output power profile of each step by a calculated percentage of the recorded power-on time (when valid) out of given 5 steps duration.

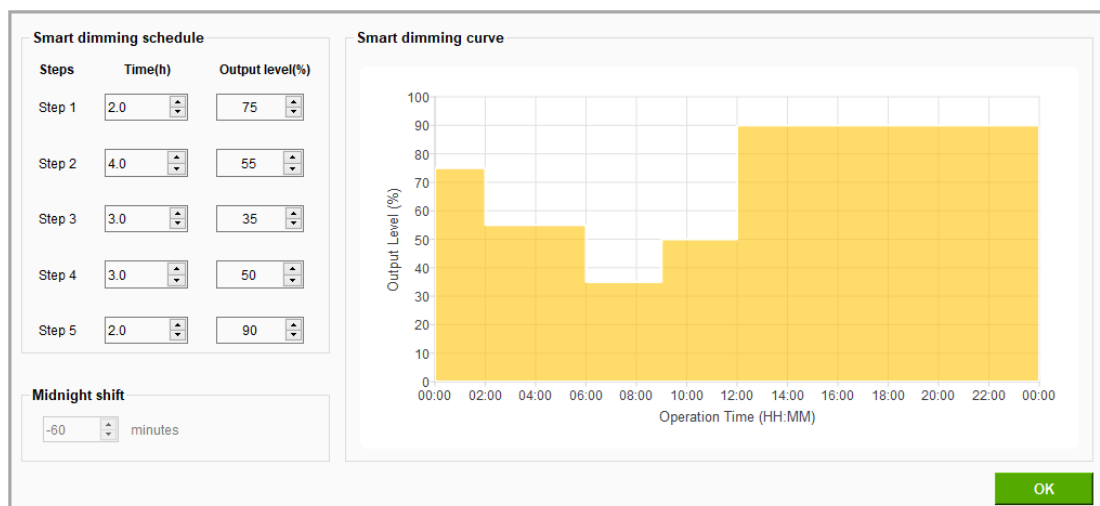

Note: When all steps are finished, the light level will remain in last level (level in step 5) for all three modes.

LED Driver

EUCI PREMIUM Series

Module Temperature Protection (for LED module)

In the LED luminaire system application, user can enable the MTP function by GUI and be taken to place the NTC thermistor close to the hottest spot on the LED module to avoid the abnormal high temperature on LED module. If LED thermal protection is not required the NTC wire of the LED driver can be left open. The de-rating limits can be programmed using the programming tool

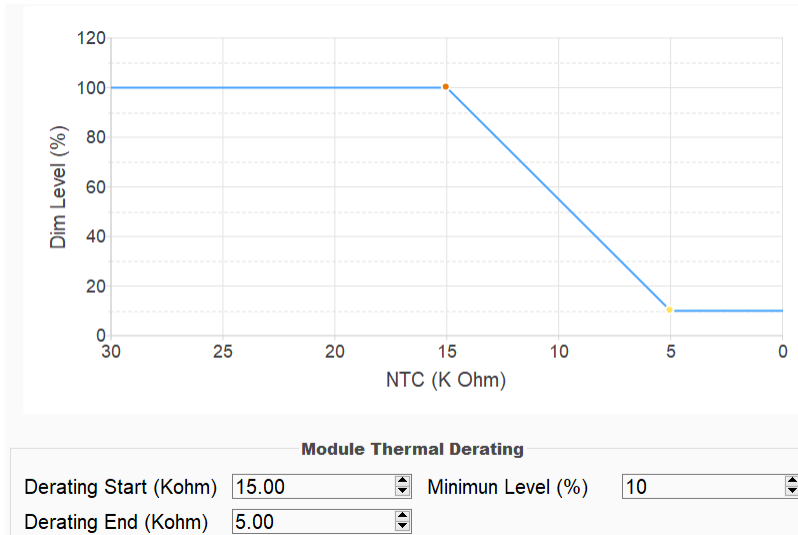

Start-up Time

The time required for the output voltage to reach 90% of its final steady state set value, after the input voltage is applied.

Rise Time

The time required for the output voltage to change from 10% to 90% of its final steady state set value.

Hold-up Time

Time between the collapse of the AC input voltage, and the output falling to 95% of its steady state set value.

■ Graph illustrating the Start-up Time, Rise Time, and Hold-up Time

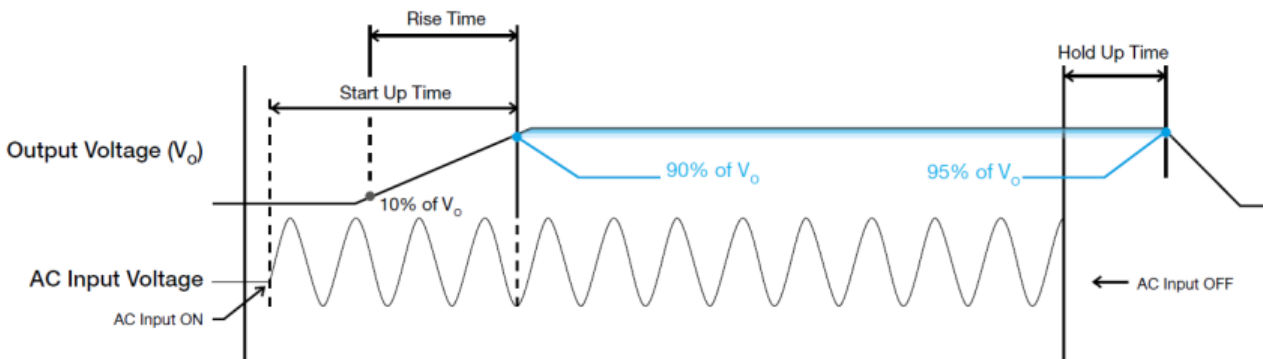

LED Driver

EUCI PREMIUM Series

Inrush Current

Inrush current is the peak, instantaneous, input current measured and, occurs when the input voltage is first applied. For AC input voltages, the maximum peak value of inrush current will occur during the first half cycle of the applied AC voltage. This peak value decreases exponentially during subsequent cycles of AC voltage.

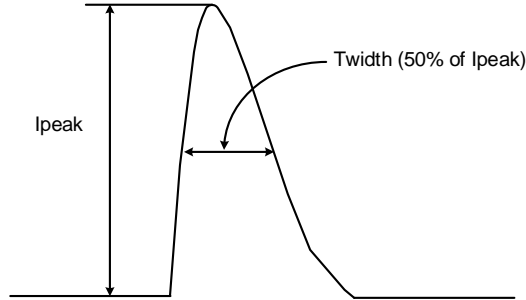

Wired Connection and NFC program

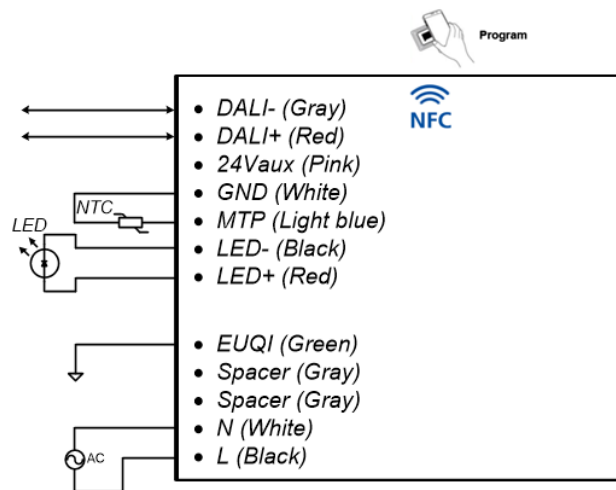

Others and Protection

Delta RoHS Compliant



Restriction of the usage of hazardous substances

The European directive 2011/65/EU limits the maximum impurity level of homogeneous materials such as lead, mercury, cadmium, chrome, polybrominated flame retardants PBB and PBDE for the use in electrical and electronic equipment. RoHS is the abbreviation for "Restriction of the use of certain hazardous substances in electrical and electronic equipment".

This product conforms to this standard.

PFC – Norm EN 61000-3-2

Line Current Harmonic content



Typically, the input current waveform is not sinusoidal due to the periodical peak charging of the input capacitor. In industrial environment, complying with EN 61000-3-2 is only necessary under special conditions. Complying with this standard can have some technical drawbacks, such as lower efficiency as well as some commercial aspects such as higher purchasing costs. Frequently, the user does not profit from fulfilling this standard, therefore, it is important to know whether it is mandatory to meet this standard for a specific application.

LED Driver

EUCI PREMIUM Series

Over Voltage Protections (Auto-Recovery)

The LED driver's Overvoltage Protections (OVP) will be activated when output voltage is achieved trigger point defined at OVP range. Upon such an occurrence, the I_o (output current) will start to droop.

Short Circuit Protection (Auto-Recovery)

The LED driver's output OLP function also provides protection against short circuits. When a short circuit is applied, the LED driver will operate in "hiccup mode". It will return to normal operation after the short circuit is removed.

Overload & Overcurrent Protection (Auto-Recovery)

The LED driver's Overload (OLP) and Overcurrent (OCP) Protections will be activated when output is between 95% and 108% of I_o (max load). Upon such an occurrence, the V_o (output voltage) will start to droop. Once the LED driver has reached its maximum power limit, the protection will be activated; and, the LED driver will operate in "CC mode". The LED driver will recover once the fault condition once the cause of OLP or OCP is removed, and I_o is back within the specified range.

Over Temperature Protection (Auto-Recovery)

As mentioned above, the LED driver also has Over Temperature Protection (OTP). In the event of a higher operating temperature at 100% load, the LED driver will run into OTP when the operating temperature is beyond what is recommended in the de-rating graph. When activated, the output voltage will go into bouncing mode until the temperature drops to its normal operating temperature as recommended in the de-rating graph.

Safety Instructions

- ALWAYS switch mains of input power OFF before connecting and disconnecting the input voltage to the device. If mains is not turned OFF, there is risk of explosion / severe damage.
- To guarantee sufficient convection cooling, keep a distance of 50mm above and lateral distance to other units.
- DO NOT insert any objects into the device.
- When the PE terminal is not connected, the device must be installed on a metal plate with PE connection.
- The current rating for the output cable must be rated higher than or equal to the output current of the power supply. Please refer to the product specifications.
- For device with dimming function, always ensure the dimming control is working properly. "Dimming 0-10V" shall be insulated from AC mains by reinforced insulation.

Others

Warranty Policy

Please reach out our [Warranty Policy](#) should you require any further clarification.