

# Medical / Industrial AC-DC Power Supply

## 1500 W Series with 5 V/2 A Standby / MEB-1K5A series



### Highlights & Features

- Up to 1500 Watt in 5" x 8.03" x 1.59" Package
- Up to 23.5 W/inch<sup>3</sup> Power Density
- Full Power up to 50°C Ambient
- Up to 500 KHrs MTBF
- 5 V/2 A Standby Output
- Current Sharing
- Conformal Coating
- Class B Conducted and Radiated EMI
- LED Indicator
- Remote On/Off control
- Analog Voltage Trimming
- Intelligent Fan Speed Control

### Safety Certifications

- IEC60601-1 3rd edition + A1+A2 CB report
- ANSI/AAMI ES 60601-1 +CAN/CSA-C22.2 NO.60601-1: (Ed.3.2005)
- UL62368-1 and CAN/CSA C22.2 No. 62368-1
- IEC 62368-1 CB report
- IEC 60950-1 CB report
- TUV EN60601-1:2006/A11/A12
- TUV EN62368-1
- CCC
- IEC 60335-1 (for 24 V model)
- IEC 61558-1/-2-16 (for 24 V model)
- TUV EN60335-1 (for 24 V model)
- TUV EN61558-1/-2-16(for 24 V model)

Input		
Input Voltage	90 Vac ~ 264 Vac	
Input Frequency	47 Hz ~ 63 Hz	
Input Current	<15 A	
Inrush Current	40 A (typ)	
Power Factor	>0.99 @ 115 Vac , full load	
Efficiency <sup>(1)</sup> @230Vac	Up to 92%	
Patient Leakage Current	<100 uA normal	
Earth Leakage Current	<500 uA normal	
Output		
Output Voltage	24 V	48 V
Output Current <sup>(2)</sup>	50.0 A @ 115 Vac 62.5 A @ 230 Vac	0-25 A @ 115 Vac 0-31.25 A@230 Vac
Ripple & Noise	<1% Vrated pk-pk	
Standby Power	5 V / 2 A (No minimum load required)	
Environmental		
MTBF	500 KHrs	
Operation Temperature <sup>(3)</sup>	-20°C ~70°C	
Operation Altitude	5000m or 54 kPa	

(1) Exclude fan power

(2) Refer to de-rating curve for detail

(3) Power de-rating with temperature above 50°C, refer to power de-rating curve for detail

# Medical / Industrial AC-DC Power Supply

## 1500 W Series with 5 V/2 A Standby / MEB-1K5A series

### Model Numbering

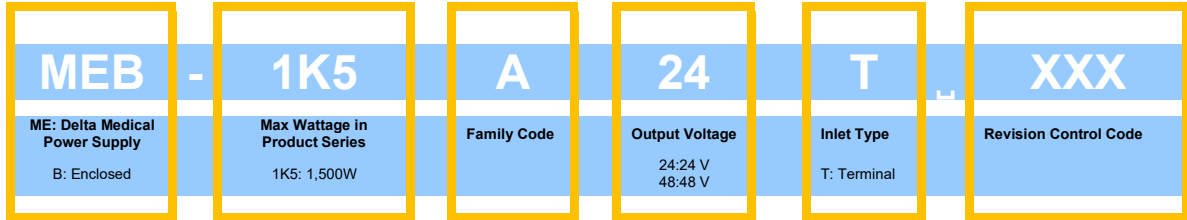

### Model Information (With 5V/2A standby available)

Model Number	Input Voltage	Output Voltage	Current Output
MEB-1K5A24T	90-264 Vac <sup>(4)</sup>	24 Vdc	62.5 A
MEB-1K5A48T		48 Vdc	31.25A

(4) Derating is needed under low AC input, please refer to derating curve for more details.

### Revision Control Code

Revision Control Code	Package
AAA	Delta Standard

# Medical / Industrial AC-DC Power Supply

## 1500 W Series with 5 V/2 A Standby / MEB-1K5A series

### Specifications

#### Input Ratings / Characteristics

Model Number		MEB-1K5A24T AAA	MEB-1K5A48T AAA
Nominal Input Voltage		100-240 Vac	
Input Voltage Range		90-264 Vac	
Nominal Input Frequency		50-60 Hz	
Input Frequency Range		47-63 Hz	
Input Current (max)		15 A	
Input Surge Voltage (max)		300 Vac for 500 ms	
Efficiency (typ)	115 Vac	88%	89%
	230 Vac	91%	92%
Inrush Current (typ)		40 A @ 264 Vac, cold start	
Input-PE(protective earth) leakage current (max)		0.5 mA @ NC, 1.0 mA @ SFC <sup>(5)</sup>	0.5 mA @ NC, 1.0 mA @ SFC <sup>(6)</sup> 0.15 mA @ NC, 0.30 mA @ SFC <sup>(7)</sup>
Output-PE(protective earth) leakage current for Type BF application (max)		0.1 mA @ NC, 0.5 mA @ SFC <sup>(5)</sup>	0.1 mA @ NC, 0.5 mA @ SFC <sup>(6)</sup> 0.1 mA @ NC, 0.2 mA @ SFC <sup>(7)</sup>
Power Factor (typ)		0.99 @ 115 V/60 Hz, full load 0.98 @ 230 V/50 Hz, full load	

(5) NC: normal condition, SFC: single fault condition

(6) NC: normal condition, SFC: single fault condition, Label Rev.00

(7) NC: normal condition, SFC: single fault condition, Label Rev.01 and above

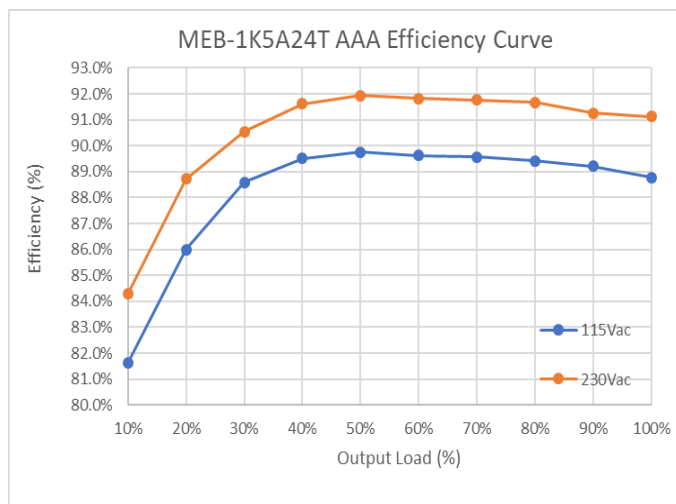

Figure 1-1. Typical efficiency Curve for MEB-1K5A24T AAA

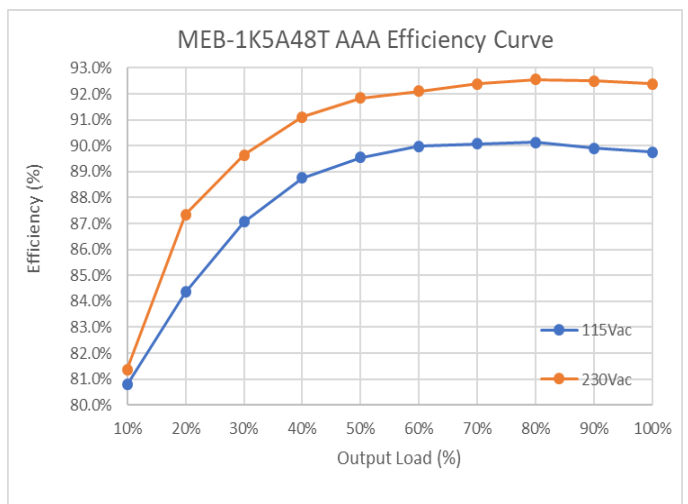

Figure 1-2. Typical efficiency Curve for MEB-1K5A48T AAA

# Medical / Industrial AC-DC Power Supply

## 1500 W Series with 5 V/2 A Standby / MEB-1K5A series

### Output Ratings / Characteristics

Total Regulation		± 3%
Output Power (max)	115 Vac	1200 W
	230 Vac	1500 W
Peak Power ( for MEB-1K5A48T AAA )		Output voltage >45 V @ 2200 W power boost for 300ms (Slew rate 0.1 A/ms, load change 1 A-45.83 A@ 230 Vac)
Line Regulation (max)		1%
Load Regulation (max)		2%
Ripple & Noise (typ.)	25°C	1% pk-pk Vrated@ rated load,
Voltage Trimming		± 10% Vrated
Dynamic Response (Overshoot & Undershoot O/P Voltage)		± 10% @ with 5-100% load change
Start-up Time (typ.)		1000 ms @ 115 Vac 500 ms @ 230 Vac
Hold-up Time (min)		16 ms @ 1200 W load, 115 Vac 12 ms @ 1500 W load, 230 Vac
Capacitive load (max)		6000 uF
Rise time (max)		<50 ms
Nominal Output Voltage of standby output (Vrated)		5 V
Nominal Output Current of standby output		2 A
Total Regulation of standby output		± 5%
Ripple & Noise of standby output		100 mV max

### Ripple & Noise measurement circuit

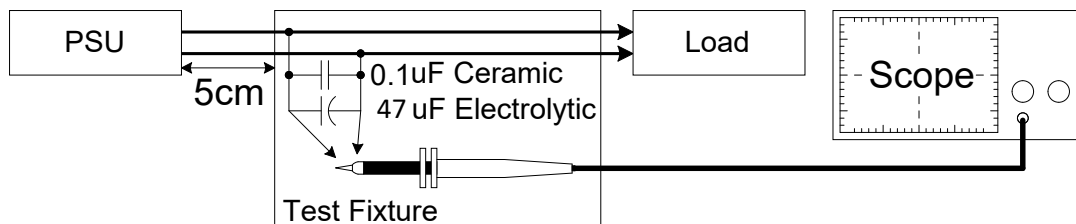

Figure 2. Ripple & Noise testing set up

### Mechanical

Package		Enclosed
Dimensions (W x L x H)		127 x 204 x 40.5 mm (5x8.03x1.59 inch)
Unit Weight		1.5 kg±0.2 kg (3.3 ±0.44 lb)
Indicator		Green LED
Terminal	INPUT	M4.0 x 3 Pins (Rated 300 V/25 A)
	OUTPUT	M3.5 x 4 Pins (Rated 300 V/32 A)
Wire		10 ~ 12 AWG <sup>(8)</sup> (2X) (FOR 48 V model)
		8 AWG * (2X) (FOR 24 V model)

(8) Only use wire that can withstand operating temperature of more than 105°C.

# Medical / Industrial AC-DC Power Supply

## 1500 W Series with 5 V/2 A Standby / MEB-1K5A series

### Environment

Surrounding Air Temperature	Operating	Absolute Maximum/Minimum Rating. -20°C to +70°C. Linear power derate from 100% load at 50°C, to 50% load at 70°C Note: see power de-rating curves below
	Storage	-40°C to +85°C
Operating Humidity	20-90% RH (Non-Condensing)	
Operating Altitude	Up to 5,000 meters (up to 16,400 feet or 106-54kPa)	
Non-Operating Altitude	Up to 5,575 meters (up to 18,290 feet or 106-50kPa)	
Shock Test (Non-Operating)	50 G, 11 ms, 3 shocks for each direction	
Vibration (Operating)	5-500 Hz, 2 Grms, 15 minute for each three axis	
Acoustic Noise <sup>(9)</sup> (typ) @ 10% load, 25°C	30 dB	
Acoustic Noise (typ) @ 80% load, 25°C	45 dB	

(9) Acoustic Noise test set up according to ISO-7779

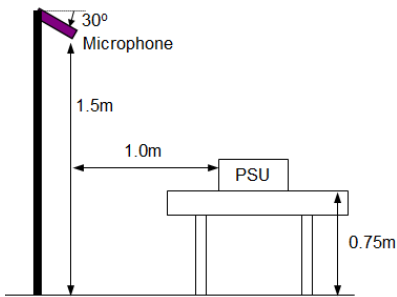

Figure 3-1. Acoustic noise testing set up

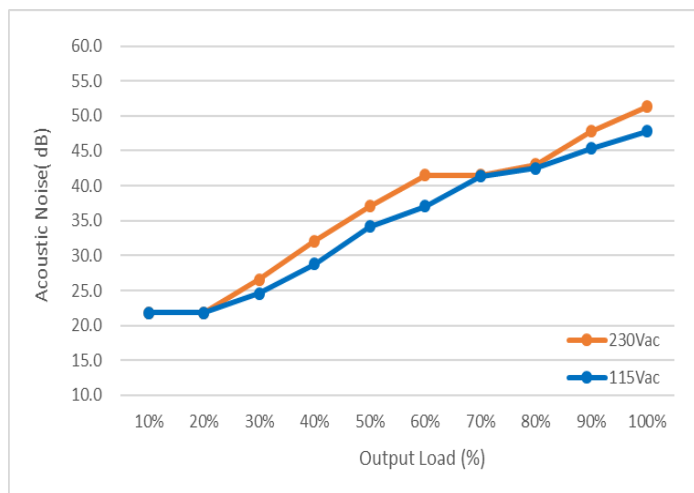

Figure 3-2. Typical acoustic noise curve for MEB-1K5A24T AAA

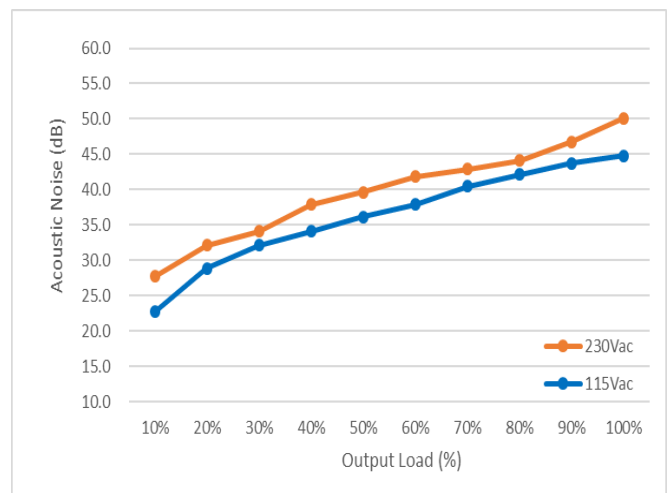
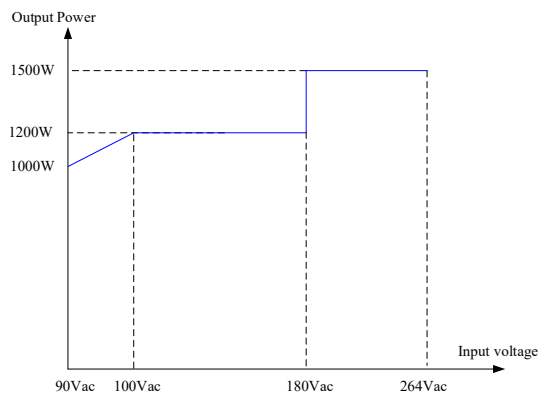
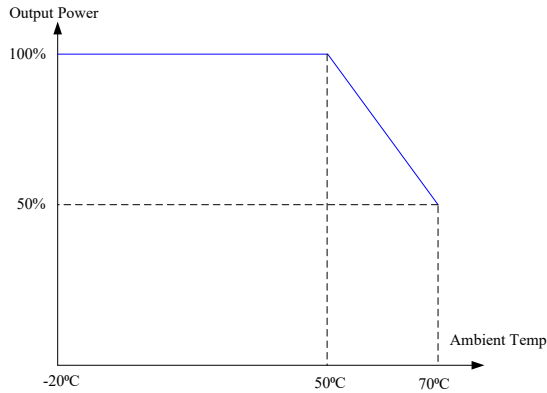

Figure 3-3. Typical acoustic noise curve for MEB-1K5A48T AAA

# Medical / Industrial AC-DC Power Supply

## 1500 W Series with 5 V/2 A Standby / MEB-1K5A series

### Power De-rating curve



### Protections (for both main output and 5Volt Standby outputs, unless otherwise indicated)

Overvoltage (max)	Main output 145% of rated normal voltage, Latch Mode
Over load / Over current (max)	Main output 135% of rated current, constant current (for 24 V) Main output 145% of rated current (for 48V) Standby 4.0 A max with Hiccup Mode (Non-Latching, Auto-Recovery)
Over Temperature	Latch Mode for Main output
Short Circuit	Hiccup Mode for Main output and Standby (Non-Latching, Auto-Recovery)

### Reliability Data

MTBF(Minimum) at 115 Vac, 1200 W, 35 °C	500 K hrs based on Telecordia SR-332
Operating life (Minimum) at 115 Vac, 1000 W, 25°C	26,280 hrs

### Safety Standards / Directives

Medical Safety	CB scheme TUV Bauart UL/cUL	IEC60601-1 3rd+A1+A2 edition CB report EN/ BS EN 60601-1:2006 ANSI/AAMI ES 60601-1+CAN/CSA-C22.2 No.60601-1: (Ed.3.2005)
ITE Safety	CB scheme CB scheme TUV Bauart UL/cUL CCC	IEC62368-1 CB report IEC60950-1 CB report EN/ BS EN 62368-1 UL62368-1+CAN/CSA62368-1 GB4943.1-2022, GB9254-2021, GB17625.1-2012
Household (for MEB-1K5A24T AAA)	CB scheme  TUV Bauart	IEC 60335-1 CB report IEC 61558-1/ -2-16 CB report EN/ BS EN 60335-1 EN/ BS EN 61558-1 / -2-16
CE		In conformance with EN 60601-1: 2006 + A11: 2011 + A1: 2013 + A12: 2014& EN 60601-1-2: 2015
UKCA		In conformance with Electromagnetic Compatibility Regulations 2016 and Medical Devices Regulations 2002 (UK MDR 2002)
Galvanic Isolation	Input to/Output Input to/Ground Output to/Ground	4000 Vac 1500 Vac 1500 Vac

# Medical / Industrial AC-DC Power Supply

## 1500 W Series with 5 V/2 A Standby / MEB-1K5A series

### EMC (Compliant with IEC 60601-1-2 4th Ed. Requirements)

EMC / Emissions		EN / BS EN 55011, BS EN / EN/ BS EN 55032 : Class B EN/ BS EN 55014-1 ( for MEB-1K5A24T AAA) CISPR 11, CISPR 32 : Class B KS C 9832 Compliance to FCC Title 47 Class
Immunity to		BS EN / EN 55035, KS C 9835, EN/ BS EN 55014-2 ( for MEB-1K5A24T AAA)
Electrostatic Discharge	IEC 61000-4-2	Level 4 Criteria A <sup>(10)(14)</sup> Air Discharge: 15 kV Contact Discharge: 8 kV
Radiated Field	IEC 61000-4-3	Criteria A <sup>(10)</sup> 80 MHz-2700 MHz, 10 V/m AM modulation Level 2 Criteria A <sup>(10)(14)</sup> 385 MHz-5785 MHz, 28 V/m Pulse mode and other Modulation
Electrical Fast Transient / Burst	IEC 61000-4-4	Level 3 Criteria A <sup>(10)</sup> 2 kV
Surge	IEC 61000-4-5	Level 3 Criteria A <sup>(10)(14)</sup> Common Mode <sup>(12)</sup> : 2 kV Differential Mode <sup>(13)</sup> : 1 kV
Conducted	IEC 61000-4-6	Level 2 Criteria A <sup>(10)(14)</sup> 150 kHz-80 MHz, 3 Vrms, 6 Vrms at ISM bands and Amateur radio bands
Power Frequency Magnetic Fields	IEC 61000-4-8	Criteria A <sup>(10)(14)</sup> Magnetic field strength 30 A/m
Voltage Dips	IEC 61000-4-11	30% 10 ms Criteria A <sup>(10)</sup> 60% 100 ms Criteria B <sup>(11)</sup> 100% 5000 ms Criteria B <sup>(11)</sup>
Voltage Dips <sup>5)</sup>	IEC 60601-1-2	Criteria A <sup>(10)</sup> @1200 W 0% UT, 0.5 cycle(10 ms) (0°,45°,90°,135°,180°,225°,270°,315°,360°) Criteria B <sup>(11)</sup> ,can meet Criteria A with 1000 W or lower load 0% UT, 1 cycle (20 ms), 0° Criteria B <sup>(11)</sup> 70% U T, 25 cycle (500 ms) , 0° Criteria B <sup>(11)</sup>
Harmonic Current Emissions	IEC/EN/BS EN 61000-3-2	Meet Class A limit
Voltage Fluctuation and Flicker	IEC/EN/BS EN 61000-3-3	

(10) Criteria A: Normal performance within the specification limits

(11) Criteria B: Output out of regulation, or shuts down during test. Automatically restored to normal operation after test.

(12) Asymmetrical: Common mode (Line to earth)

(13) Symmetrical: Differential mode (Line to line)

(14) Compliant with IEC60601-1-2 4th Edition

# Medical / Industrial AC-DC Power Supply

## 1500 W Series with 5 V/2 A Standby / MEB-1K5A series

### Dimensions

#### Mechanical drawing

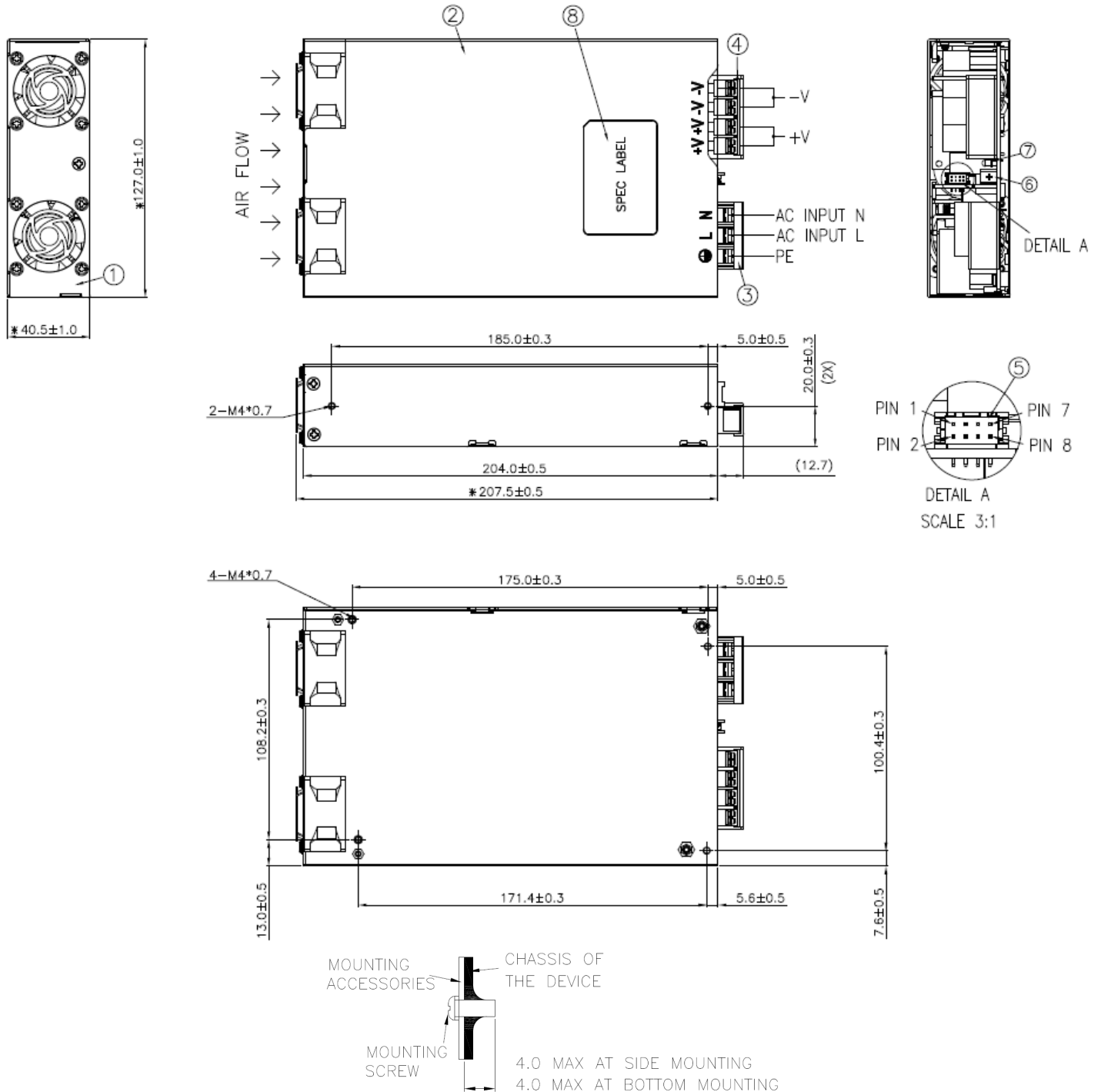

Fig. 4

#### Notes:

1. Bottom mounting, maximum penetration 4.0 mm from outside face of chassis. (refer to Fig.4)
2. Side mounting, maximum penetration 4.0 mm from outside face of chassis. (refer to Fig.4)
3. Recommended mounting torque of the product is 5 ~ 8 kgf.cm.



# Medical / Industrial AC-DC Power Supply

## 1500 W Series with 5 V/2 A Standby / MEB-1K5A series

### Connector Definition and Pin Assignment

Item	Part Name	Remarks
1	Chassis (SGCC 0.8T)	Nature
2	Cover (SGCC 0.8T)	Nature
3	Input Terminal DECA T25-E03H03	Black
4	Output Terminal ANYTEK YK50A0423009G	Black
5	Control Connector WAFER: CVILUX CI0108P1HDL-NH or EQUIVALENT MATING HOUSING: CVILUX CI0108SD0L0 or EQUIVALENT TERMINAL: CVILUX CI01TD21PE0 or EQUIVALENT  <u>Pin Assignment</u> Pin 1: Current Sharing Pin 2: Remote On/Off + Pin 3: GND Pin 4: Remote On/Off - Pin 5: GND Pin 6: GND Pin 7: 5 V Output Pin 8: 5 V Output	-
6	VR	-
7	LED	Green
8	Spec Label	White

# Medical / Industrial AC-DC Power Supply

## 1500 W Series with 5 V/2 A Standby / MEB-1K5A series

### Functions

#### Start-up Time

The time required for the output voltage to reach 90% of its final steady state value, after the input voltage is applied

#### Rise Time

The time required for the output voltage to change from 10% to 90% of its final steady state value.

#### Hold-up Time

Time between the collapse of the AC input voltage, and the output falling to 90% of its steady state value

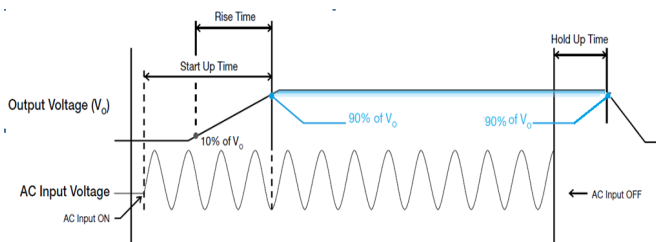

Figure 5. Time sequence

#### Dynamic Response (Main Output)

The power supply output voltage will remain within  $\pm 10\%$  of its steady state value, when subjected to a dynamic load 5 to 100% of its rated current.

#### ■ 5 to 100% Load

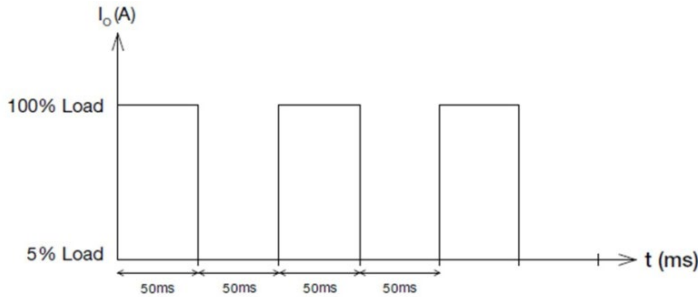

Figure 6. Dynamic Load

#### Inrush Current

Inrush current is the input current that occurs when the input voltage is first applied. For AC input voltages, the maximum peak value of inrush current will occur during the first half cycle of the applied AC voltage. This peak value decreases exponentially during subsequent cycles of AC voltage.

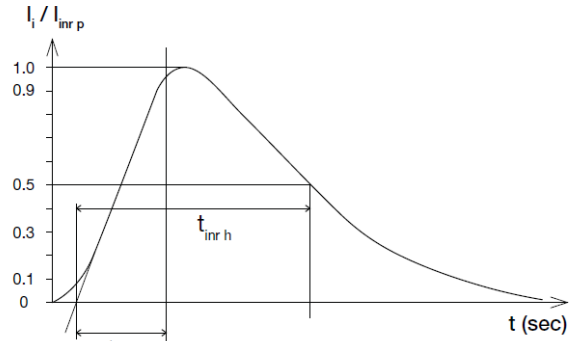

Figure 7. Inrush Current

#### Overvoltage Protection

The power supply's overvoltage circuit will be activated when its internal feedback circuit fails. The output voltage shall not exceed its specifications defined on Page 5 under "Protections". Power supply will latch off, and require removal/re-application of input AC voltage in order to restart.

#### Overload & Over current Protections

The power supply (24V)'s main output Overload (OLP) and Over current (OCP) protections is achieved by constant output current control. If the output current increases higher than rated current, the current will be clamped to be constant ( $< 130\%$  rated current), output voltage will then drop if output impedance keeps decreasing in the constant current control. Finally output under voltage protection will be triggered if the output voltage falls below 75% rated value and enters "Hiccup mode" (Auto-Recovery). The power supply will recover once the fault condition causing the OLP and OCP is removed and IO is back within the specified limit.

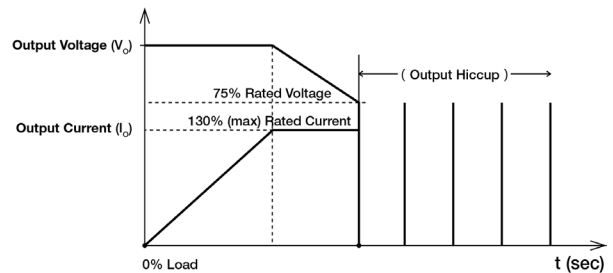

Figure 8. Hiccup at OLP/OCP

Additionally, if the  $I_{out}$  is  $> 100\%$  for a prolong period of time (depending on the load), the Over Temperature Protection (OTP) may be activated due to high temperature on critical components. The power supply will then go into latch mode.

# Medical / Industrial AC-DC Power Supply

## 1500 W Series with 5 V/2 A Standby / MEB-1K5A series

### Short Circuit Protection

Output OLP/OCF function also provides protection against short circuits. When a short circuit is applied, the output current will operate in “Hiccup mode”, The power supply will return to normal operation after the short circuit is removed.

### Over Temperature Protection

As mentioned above, the power supply also has Over Temperature Protection (OTP). This is activated when the overload condition persists for an extended duration and the output current is below the overload trigger point but >100% load. In the event of a higher operating temperature condition at 100% load, the power supply will run into OTP when the surrounding air temperature is higher than the operating temperature. When activated, the output voltage will go into latch mode until the input voltage is removed; then, reapplied, and the surrounding air temperature drops to its normal operating temperature.

### Remote On/Off

Remote ON/OFF signal can be used to enable or disable the main output. When the main output is disabled, the +5 V Standby output will stop operating. System can use a switch to conduct to disable the main output. The signal can be floated (no connection to the signal), in order to enable the main output.

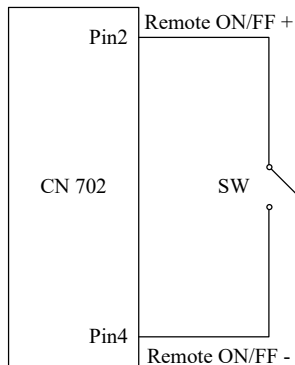

Figure 9. Remote On/Off Connection

### Voltage Adjustment

The power supply provides a potentiometer for user to adjust the output voltage. The output voltage is designed to be able to adjust up to  $\pm 10\%$  of rated voltage, when the output is adjusted below nominal value, the maximum output current is the same as the nominal output, when the output is adjusted above nominal value, the output power cannot exceed the nominal maximum power (the maximum output current will be reduced accordingly).

### Current Sharing

The power supply has an active current sharing circuit for the main output; it can realize the output current to be balanced when customer is using up to six power supplies in parallel to achieve higher output power. A one wire current share bus is used to achieve current sharing between units, the current share bus must be connected together among different units (pin 1 of item5, refer to power supply mechanical drawing and pin assignment). The difference in output voltage can impact the current sharing accuracy, all the units to be paralleled, please use the voltage adjustment function to set the voltage to be  $\pm 50$  mV of the set value, and the maximum output current set at 80% of rated output current.

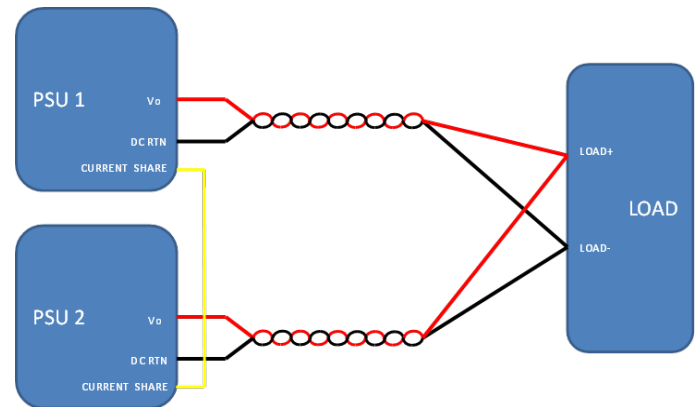

Fig. 10: Parallel connection

SW OFF (open)	SW ON (close)
Power supply turn on	Power supply turn off

# Medical / Industrial AC-DC Power Supply

## 1500 W Series with 5 V/2 A Standby / MEB-1K5A series

### Certificate



All Delta Medical Power products conform to the European directive 2011/65/EU. ROHS is the abbreviation for "Restriction of the use of certain hazardous substances"



Delta has been certified as meeting the requirement of ISO 13485: 2003 and EN ISO 13485:2012 for the design and manufacture of switching power supply and adaptor for medical device.



In addition to a UL Total Certification Program (TCP) approved client laboratory for IEC 60950 and IEC 60065. Delta also has participated UL Client Test Data Program (CDTP) for IEC 60601

### Attention

Delta provides all information in the datasheets on an "AS IS" basis and does not offer any kind of warranty through the information for using the product. In the event of any discrepancy between the information in the catalog and datasheets, the datasheets shall prevail (please refer to [www.DeltaPSU.com](http://www.DeltaPSU.com) for the latest datasheets information). Delta shall have no liability of indemnification for any claim or action arising from any error for the provided information in the datasheets. Customer shall take its responsibility for evaluation of using the product before placing an order with Delta.

Delta reserves the right to make changes to the information described in the datasheets without notice.

### Manufacturer and Authorized Representatives Information

#### Manufacturer

Thailand  
Delta Electronics (Thailand) PCL.  
909 Pattana 1 Rd., Muang, Samutprakarn, 10280 Thailand

Taiwan  
Delta Electronics, Inc.  
3 Tungyuan Road, Chungli Industrial Zone, Taoyuan County  
32063, Taiwan

#### Authorized Representatives

The Netherlands  
Delta Greentech (Netherlands) B.V.  
Zandsteen 15, 2132 MZ Hoofddorp, The Netherlands

United Kingdom  
Delta Electronics Europe Limited  
1 Redwood Court, Peel Park Campus,  
East Kilbride, Glasgow, G74 5PF, United Kingdom