

PMR Panel Mount Power Supply

PMR 1,500 W series / PMR-□V1K5W1BT□

PMR



Highlights & Features

- Universal AC input voltage
- Up to 1,500 Watt in 8.03" x 5" x 1.59" package
- Up to 23.5 W/inch³ power density
- Peak power supported
- Full power up to 50°C ambient
- Up to 500 KHrs MTBF
- 5 V / 2 A standby output
- Active current sharing
- Conformal coating
- Class B Conducted and Radiated EMI
- Remote On/Off control
- Analog voltage trimming
- Intelligent fan speed control
- Compliance to SEMI F47 @ 200Vac

Safety Standards



CB Certified for worldwide use

Model Number: PMR-□V1K5W1BT□
Unit Weight: 1.5 kg (3.3 lb)
Dimensions (L x W x H): 204 x 127.0 x 40.5 mm
 (8.03 x 5 x 1.59 inch)

General Description

The PMR Series 1,500 W power supply offers a nominal output voltage of 24 V or 48 V across a wide operating temperature range from -20°C to +70°C. It is certified for shock and vibration under IEC 60068-2 standards. Designed with a 1U low profile, it is ideal for installation in space-constrained environments. The power supply also features a universal AC input voltage range of 90 Vac to 264 Vac. Additionally, its built-in active PFC circuit ensures a high power factor and compliance with harmonic current emission standards IEC/EN 61000-3-2, Class A.

Model Information

PMR Panel Mount Power Supply

Model Number	Input Voltage Range	Rated Output Voltage	Rated Output Current
PMR-24V1K5W1BTB	90 Vac ~ 264 Vac *1	24 Vdc	62.5 A
PMR-48V1K5W1BTC		48 Vdc	31.25 A

*1 Derating is needed under low AC input, please refer to derating curve for more details.

Model Numbering

							CC code
PM	R –	□V	1K5W	1	B	T	□
Panel Mount	Product Type R – Standard Rack Type Series (1U)	Output Voltage 24 – 24 V 48 – 48 V	Output Power	Single Phase	Family Code: B	Connector Type T – Terminal Block	B – Remote On/Off & Constant current mode protection*2 C – Remote On/Off & without Constant current mode protection*2

*2: B – 24V only / C –48V only



PMR Panel Mount Power Supply

PMR 1,500 W series / PMR-□V1K5W1BT□

Specifications

Model Number	PMR-24V1K5W1BTB	PMR-48V1K5W1BTC
--------------	-----------------	-----------------

Input Ratings / Characteristics

Nominal Input Voltage	100-240 Vac	
Input Voltage Range	90-264 Vac	
Nominal Input Frequency	50-60 Hz	
Input Frequency Range	47-63 Hz	
Input Current (max)	15 A	
Efficiency at 100% Load @ 230Vac	91% typ.	92% typ.
Max Inrush Current (Cold Start)	40 A @ 264 Vac, cold/hot start	
Power Factor at 100% Load	0.99 @ 115 V/50 Hz, 0.98 @ 230 V/50 Hz	
Leakage Current	< 0.5 mA @ 240Vac	

Output Ratings / Characteristics*³

Nominal Output Voltage	24 Vdc	48 Vdc
Total Regulation	± 3%	± 3%
Output Voltage Adjustment Range	24-28 Vdc	48-56 Vdc
Output Current	62.5 A	31.25 A
Output Power	1,500 W Max.	
Peak Power (max)	24 V: 2,200 W peak for 3 sec, @ 180~264 Vac 48 V: 2,200 W peak for 3 sec, @ 180~264 Vac	
Line Regulation	± 0.5%	
Load Regulation	± 1%	
PARD* ⁴ (20MHz)	<1% Vrated pk-pk @ rated load	
Rise Time	<50 ms	
Start-up Time	1000 ms @ 115 Vac, 500 ms @ 230 Vac	
Hold-up Time	16 ms @ 1200 W load, 115 Vac 12 ms @ 1500 W load, 230 Vac	
Dynamic Response (Overshoot & Undershoot O/P Voltage)	± 10% @ with 5-100% load change	
Start-up with Capacitive Loads	6000 uF	
Nominal Standby Voltage Output* ⁵	5 V	
Nominal Standby Current Output	2 A	
Total Regulation of Standby Output	± 5%	
Ripple & Noise of Standby Output	100 mV max	

*³ For power de-rating from > 50°C to 70°C, see power de-rating on page 9.

*⁴ PARD is measured with an AC coupling mode, and in parallel to end terminal with 0.1 µF ceramic capacitor & 47 µF electrolytic capacitor. PSU need to burn in > 5 minutes when AMB ≤ 0°C

*⁵ 5 V standby output is always on when AC is present

PMR Panel Mount Power Supply

PMR 1,500 W series / PMR-□V1K5W1BT□

Model Number	PMR-24V1K5W1BTB	PMR-48V1K5W1BTC
---------------------	-----------------	-----------------

Mechanical

Case Chassis	SGCC
Case Cover	SGCC
Dimensions (L x W x H)	204 x 127 x 40.5 mm (8.03 x 5 x 1.59 inch)
Unit Weight	1.5 kg (3.3 lb)
Indicator	Green LED
Cooling System	Force Cooling
Terminal	M 4.0 x 3 Pins, CN1 / AC Input M 3.5 x 4 Pins, CN101 / DC Output
Wire	8 AWG*6 (2X) (For 24 V model) 10~12 AWG*6 (2X) (For 48 V model)

*6 Only use wire that can withstand operating temperature of more than 105°C.

Environment

Surrounding Air Temperature	Operating	-20°C to +70°C
	Storage	-40°C to +85°C
Power De-rating	Temperature	> 50°C de-rate power by 2.5%/°C Note: see power de-rating curves on page 9
	Input	1,500W @ 180-264Vac; 1,200W @ 180-100Vac; 1,200W de-rate power by 1.33%/Vac @ 90-100Vac; 1,000W @ 90Vac
Operating Humidity		20-90% RH (Non-Condensing)
Operating Altitude		0 to 5,000 Meters (0 to 16,400 ft)
Shock Test	Non-Operating	IEC 60068-2-27, Half Sine Wave: 50 G for duration of 11 ms; 3 times per direction
Vibration	Operating	IEC 60068-2-6, Sine Wave: 5 Hz to 500 Hz @ 2G; 15 min for X, Y, Z direction
Pollution Degree		2
Acoustic Noise*7	Tolerance: ±2dB	< 45dB @ 80% load @ 25°C

*7 Acoustic Noise test set up according to ISO-7779

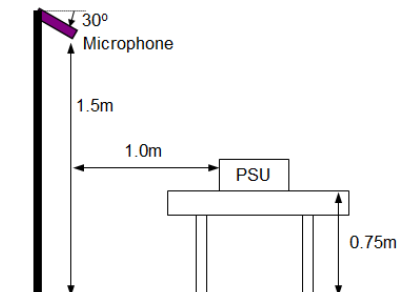

Fig 1. Acoustic Noise Testing Set Up

PMR Panel Mount Power Supply

PMR 1,500 W series / PMR-□V1K5W1BT□

Model Number	PMR-24V1K5W1BTB	PMR-48V1K5W1BTC
--------------	-----------------	-----------------

Protections

Overvoltage (max)	Main output 145% of rated normal voltage, Latch Mode
Overload / Overcurrent	Main output 130% of rated load current, Hiccup Mode, Non-Latching (Auto-Recovery) Standby 3.2A max with Hiccup Mode (Auto-Recovery)
Over Temperature	Latch Mode for Main output
Short Circuit	Hiccup Mode to Main output / Standby (Auto-Recovery when the fault is removed)
Protection Against Shock	Class I with PE*8 connection

*8 PE: Protection Earth

Reliability Data

MTBF	500K hrs based on Telcordia SR-332 (@ 115 Vac, 1200W, 35°C)
Expected Cap Life Time	26,280 hrs, (@115 Vac, 1000W @ 25°C)

Safety Standards / Directives

Safety Entry Low Voltage	SELV	
Electrical Safety	TUV Bauart UL/cUL CB scheme CCC BIS	EN 62368-1 UL 62368-1 and CAN/CSA C22.2 No. 62368-1 IEC 62368-1 GB 17625.1 IS 13252 (Part 1)
Household (for 24V only)	CB scheme TUV Bauart	IEC 60335-1 & IEC 61558-1/ -2-16 EN 60335-1 & IEC 61558-1/ -2-16
CE		In conformance with EMC Directive 2014/30/EU and Low Voltage Directive 2014/35/EU
UKCA		In conformance with Electromagnetic Compatibility Regulations 2016 and Electrical Equipment (Safety) Regulations 2016
Galvanic Isolation	Input to Output Input to Ground Output to Ground	4.0 KVac 1.5 KVac 1.5 KVac

PMR Panel Mount Power Supply

PMR 1,500 W series / PMR-□V1K5W1BT□

Model Number	PMR-24V1K5W1BTB	PMR-48V1K5W1BTC
---------------------	-----------------	-----------------

EMC

Emissions (CE & RE)	EN55032, KS C 9832, Comply to FCC Title 47: Class B		
Immunity	EN 55035, KS C 9835		
Electrostatic Discharge	IEC 61000-4-2	Level 4 Criteria A ¹⁾ Air Discharge: 15 kV Contact Discharge: 8 kV	
Radiated Field	IEC 61000-4-3	Criteria A ¹⁾ 80MHz-2700MHz, 10V/m AM modulation Level 2 Criteria A ¹⁾ 385MHz-5785MHz, 28V/m Pulse mode and other modulation	
Electrical Fast Transient / Burst	IEC 61000-4-4	Level 3 Criteria A ¹⁾ : 2kV	
Surge	IEC 61000-4-5	Level 3 Criteria A ¹⁾ Common Mode ⁴⁾ : 2kV Differential Mode ⁵⁾ : 1kV	
Conducted	IEC 61000-4-6	Level 2 Criteria A ¹⁾ 150kHz-80MHz, 3Vrms, 6Vrms at ISM bands and Amateur radio bands	
Power Frequency Magnetic Fields	IEC 61000-4-8	Criteria A ¹⁾ Magnetic field strength 30A/m	
Voltage Dips and Interruptions	IEC 61000-4-11	30% 10ms Criteria A ¹⁾ 60% 100ms Criteria B ²⁾ 100% 500ms Criteria B ²⁾	
Harmonic Current Emission	IEC/EN 61000-3-2	Meet Class A limit	
Voltage Fluctuation and Flicker	EN 61000-3-3		
Voltage Sag Immunity SEMI F47 – 0706	80% of 200 Vac	160 Vac, 1000ms	Criteria A ¹⁾
	70% of 200 Vac	140 Vac, 500ms	Criteria A ¹⁾ @ 1200W & Criteria B ²⁾ @ 1500W
	50% of 200 Vac	100 Vac, 200ms	Criteria A ¹⁾ @ 1200W & Criteria B ²⁾ @ 1500W

1) Criteria A: Normal performance within the specification limits

2) Criteria B: Output out of regulation, or shuts down during test. Automatically restored to normal operation after test.

3) Criteria C: Output out of regulation, shuts down during test (Need to recycle AC power cord to normal operation after test)

4) Asymmetrical: Common mode (Line to earth)

5) Symmetrical: Differential mode (Line to line)

PMR Panel Mount Power Supply

PMR 1,500 W series / PMR-□V1K5W1BT□

Block Diagram

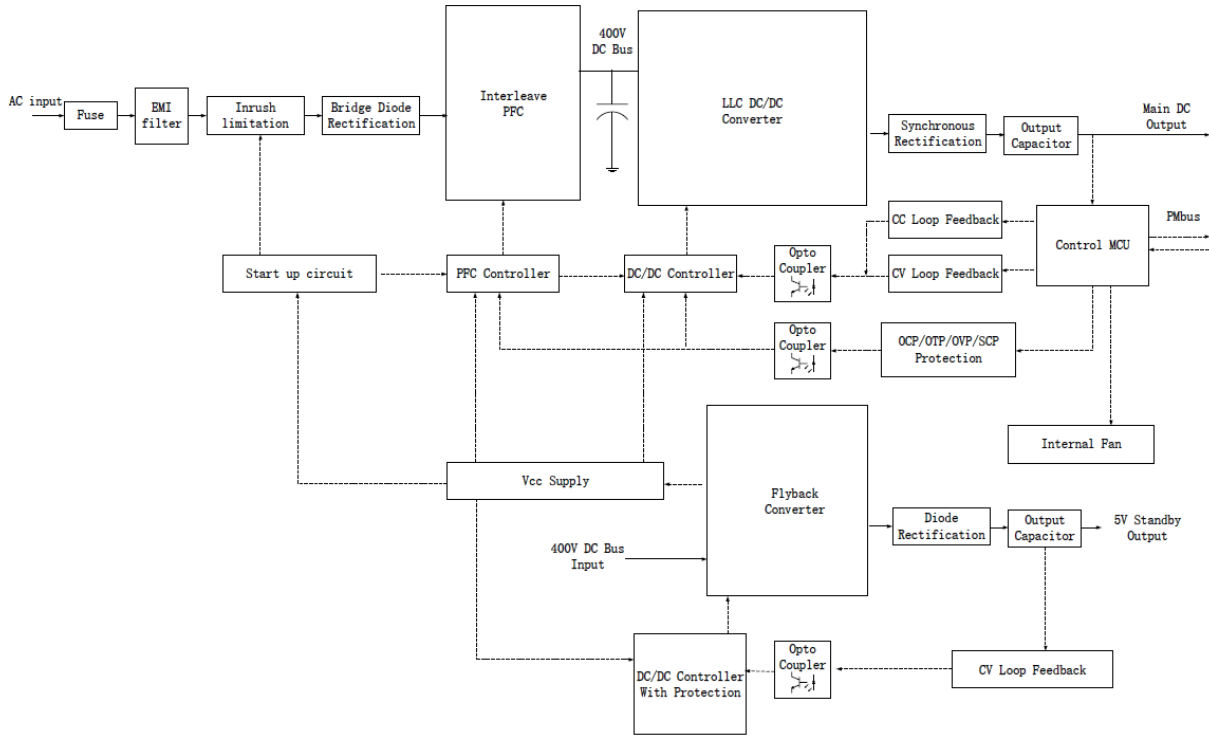

Device Descriptions

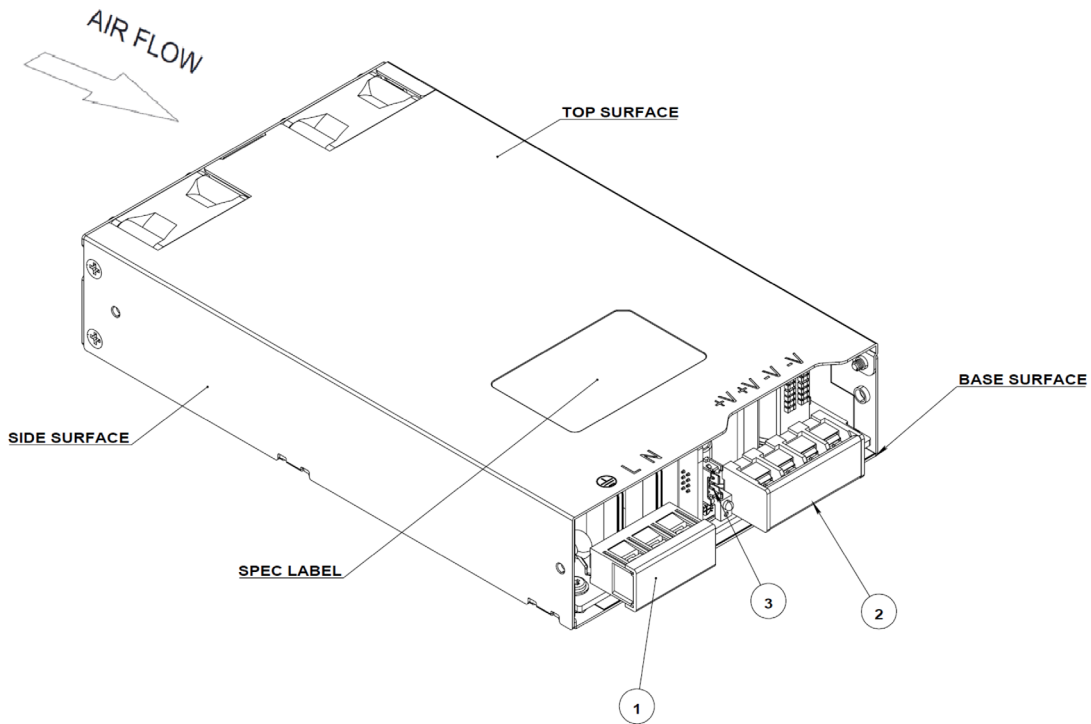

- 1) Input terminal block connector
- 2) Output terminal block connector
- 3) Communication block connector

PMR Panel Mount Power Supply

PMR 1,500 W series / PMR-□V1K5W1BT□

Dimensions

L x W x H: 204 x 127.0 x 40.5 mm (8.03 x 5 x 1.59 inch)

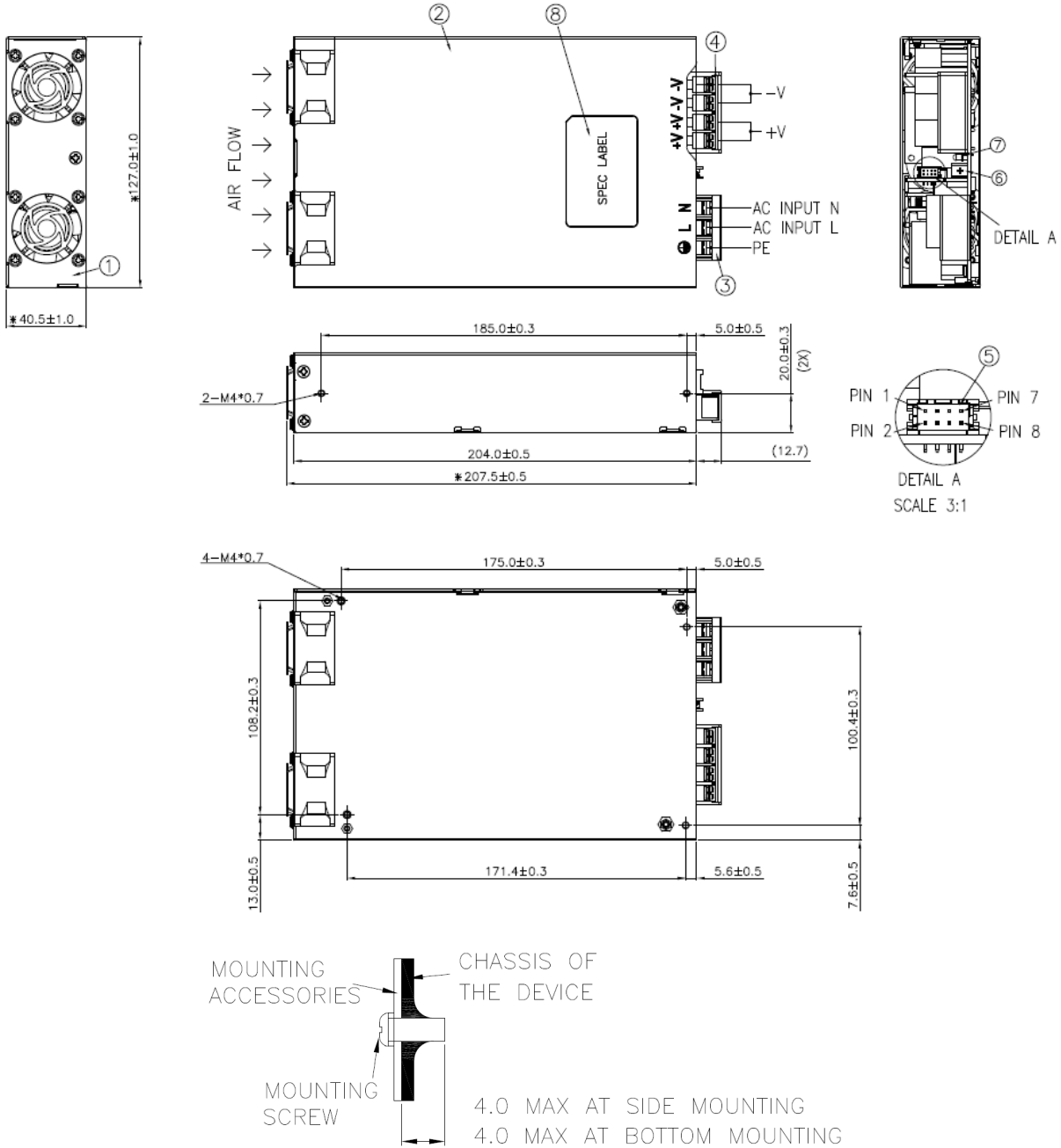

Fig. 2 Mounting Screw

Notes:

1. Base plate mounting, M4 thread holes, maximum penetration 3.0 mm (0.12 inch) from outside face of chassis, maximum torque 9-10 kgf.cm (7.82-8.69 inch.lbs). (refer to Fig. 5)
2. Side mounting, M4 thread holes, maximum penetration 3.0 mm (0.12 inch) from outside face of chassis, maximum torque 9-10 kgf.cm (7.82-8.69 inch.lbs). (refer to Fig. 5)
3. CN101, M3.5 screw in four positions, maximum torque 6-7 kgf.cm (5.21-6.08 inch.lbs).
4. CN1, M4 screw in two positions, maximum torque 9-10 kgf.cm (7.82-8.69 inch.lbs).
5. VR: clockwise is to increase the output voltage, anti-clockwise is to reduce the output voltage.
6. Built-in cooling fan. Must prevent dust suction into power supply, or use natural convection power supply if any concerns.
7. All dimensions are in millimeters and inches

PMR Panel Mount Power Supply

PMR 1,500 W series / PMR-□V1K5W1BT□

Connector Definition and Pin Assignment

Item	Part Name	Remarks
1	Chassis (SGCC 0.8T)	Nature
2	Cover (SGCC 0.8T)	Nature
3	Input Terminal DECA T25-E03H03	Black
4	Output Terminal ANYTEK YK50A0423009G	Black
5	Control Connector WAFER: CVILUX CI0108P1HDL-NH or EQUIVALENT MATING HOUSING: CVILUX CI0108SD0L0 or EQUIVALENT TERMINAL: CVILUX CI01TD21PE0 or EQUIVALENT Pin Assignment Pin 1: Current Sharing Pin 2: Remote On/Off + Pin 3: GND Pin 4: Remote On/Off - Pin 5: GND Pin 6: GND Pin 7: 5 V Output Pin 8: 5 V Output	-
6	VR	-
7	LED	Green
8	Spec Label	White

PMR Panel Mount Power Supply

PMR 1,500 W series / PMR-□V1K5W1BT□

Engineering Data

Output Load De-rating VS Surrounding Air Temperature

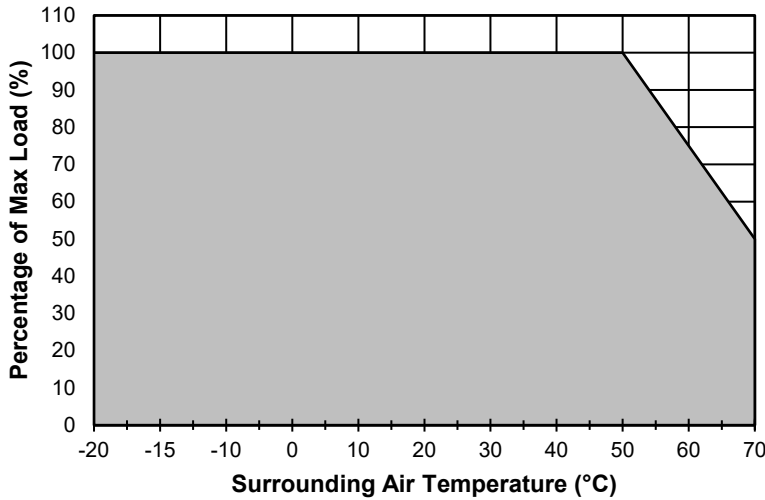
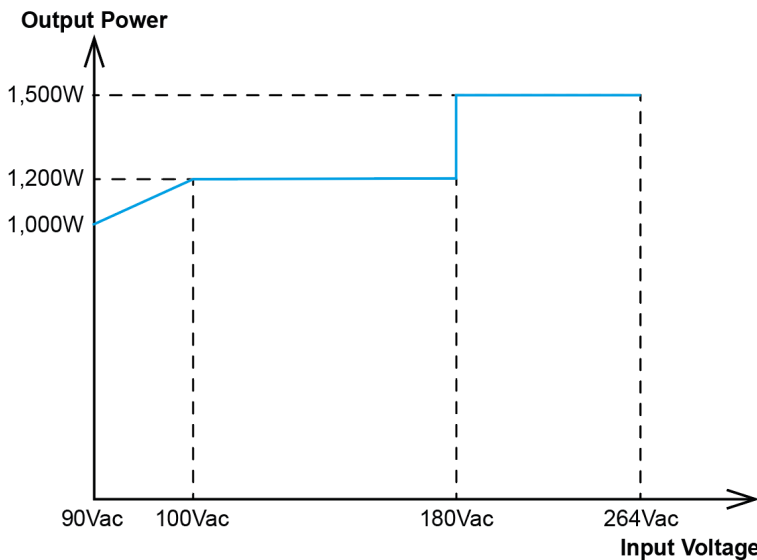

Fig. 3 De-rating for Horizontal Mounting Orientation
 > 50°C de-rate power by 2.5% / °C

Note

1. Power supply components may degrade, or be damaged, when the power supply is continuously used outside the shaded region, refer to the graph shown in Fig. 3 & Fig. 4.
2. The PSU will be bouncing and start up time will not exceed 5s when ambient temperature at -20°C.
3. If the output capacity is not reduced when the surrounding air temperature >50°C, the device will run into Over Temperature Protection. When activated, power supply will latch off, until the surrounding air temperature is lowered or the load is reduced as far as necessary to keep the device in working condition, and require removal/re-application of input AC voltage in order to restart.
4. In order for the device to function in the manner intended, it is also necessary to keep a safety distance as recommended in the safety instructions while the device is in operation.
5. Depending on the surrounding air temperature and output load delivered by the power supply, the device can be very hot!

Output Load De-rating VS Input Voltage



- No output power de-rating for the input voltage from 180 Vac to 264 Vac

Fig. 4 De-rating for AC Input Voltage

1,500 W @ 180-264 Vac; 1,200 W @ 100-180 Vac;
 1,200 W de-rate power by 1.33%/Vac @ 90-100 Vac; 1,000 W @ 90 Vac

PMR Panel Mount Power Supply

PMR 1,500 W series / PMR-□V1K5W1BT□

Assembly & Installation

- Ⓐ Base Mounting: Fig. 5 shows the mounting hole locations for power supply assembly onto a metal mounting surface.
- Ⓑ This surface belongs to customer's end system or panel where the power supply is mounted.
- Ⓒ Connector

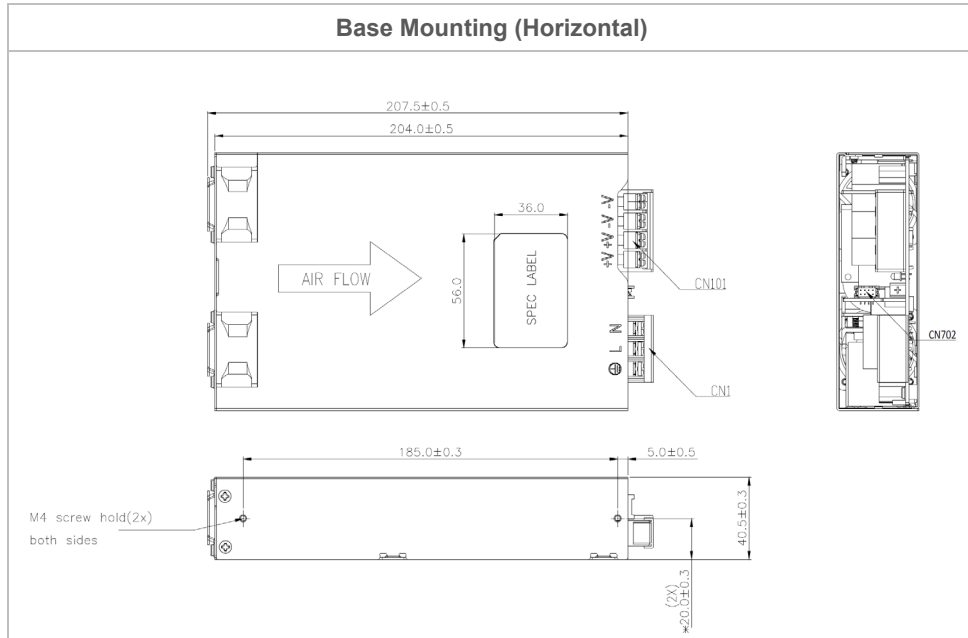

* If the device has to be mounted in any other orientation, please leave a message via the [Contact Us](#) form.

- Use flexible cable (stranded or solid) of AWG No. 6. User should calculate and select the suitable wire specification (type/quantity/diameter) according to actual output current. The torque at the Connector shall not exceed 6-7kgf.cm (5.21-6.08 inch.lbs). The insulation stripping length should not exceed 0.275" or 7 mm. (Refer to Fig. 5).

PMR Panel Mount Power Supply

PMR 1,500 W series / PMR-□V1K5W1BT□

Installation of Mounting Accessories

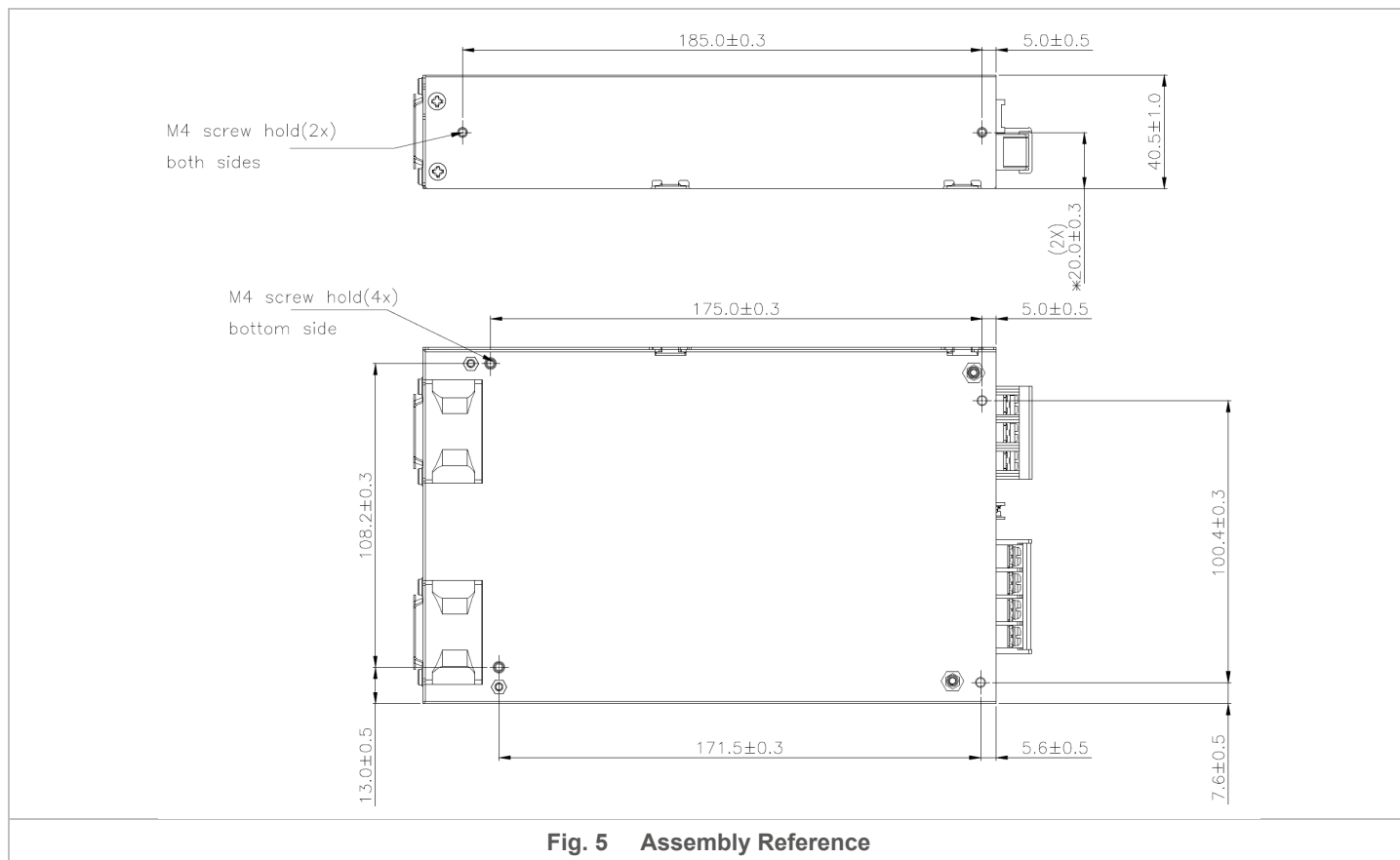

Safety Instructions

- If user's mounting orientation is not according to the recommended mounting orientations, please consult Delta for further information.
- To ensure sufficient convection cooling, always maintain a safety distance of ≥ 50 mm (1.97 inch) from all ventilated surfaces while the device is in operation.
- The device is not recommended to be placed on low thermal conductive surface. For example, plastics.
- The enclosure of the device can become very hot depending on the ambient temperature and load of the power supply. Do not touch the device while it is in operation or immediately after power is turned OFF. Risk of burning!
- Do not touch the terminals while power is being supplied. Risk of electric shock.
- Prevent any foreign metal, particles or conductors from entering the device through the openings during installation. It may cause: Electric shock; Safety Hazard; Fire; Product failure
- The power supply must be mounted by metal screws onto a grounded metal surface. It is highly recommended that the Earth terminal on the connector be connected to the grounded surface.

PMR Panel Mount Power Supply

PMR 1,500 W series / PMR-□V1K5W1BT□

Functions

Start-up Time

The time required for the output voltage to reach 90% of its final steady state value, after the input voltage is applied

Rise Time

The time required for the output voltage to change from 10% to 90% of its final steady state value.

Hold-up Time

Time between the collapse of the AC input voltage, and the output falling to 90% of its steady state value

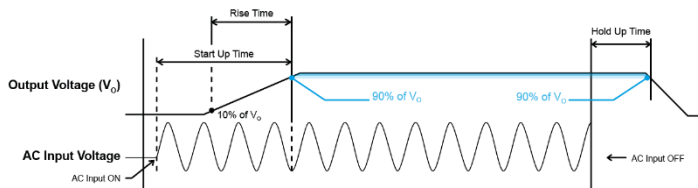

Fig. 6 Time Sequence

Dynamic Response (Main Output)

The power supply output voltage will remain within $\pm 5\%$ of its steady state value, when subjected to a dynamic load 50 to 100% of its rated current.

■ 50 to 100% Load

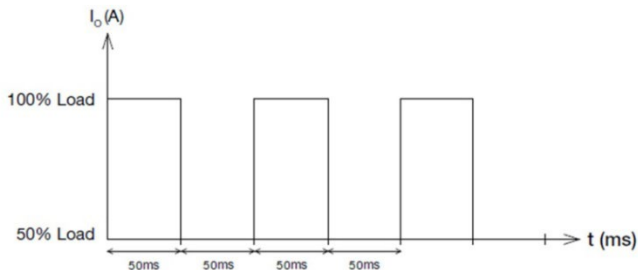

Fig. 5 Dynamic Load

Inrush Current

Inrush current is the input current that occurs when the input voltage is first applied. For AC input voltages, the maximum peak value of inrush current will occur during the first half cycle of the applied AC voltage. This peak value decreases exponentially during subsequent cycles of AC voltage.

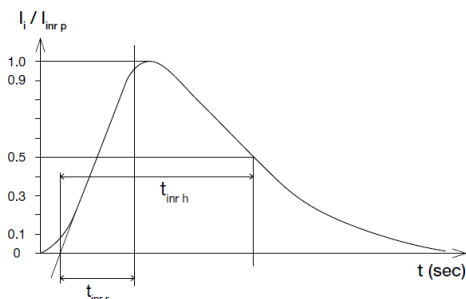

Fig. 7 Inrush Current

Overvoltage Protection

The power supply's overvoltage circuit will be activated when its internal feedback circuit fails. The output voltage shall not exceed its specifications defined on Page 3 under "Protections". Power supply will latch off, and require removal/re-application of input AC voltage in order to restart.

Overload & Over Current Protections

The power supply's main output overload (OLP) and over current (OCP) protections is achieved by constant output current control. If the output current increases higher than rated current, the current will be clamped to be constant (<130% rated current), output voltage will then drop if output impedance keeps decreasing in the constant current control. Finally output under voltage protection will be triggered if the output voltage falls below 75% rated value and enters "Hiccup mode" (Auto-Recovery). The power supply will recover once the fault condition causing the OLP and OCP is removed and I_o is back within the specified limit.

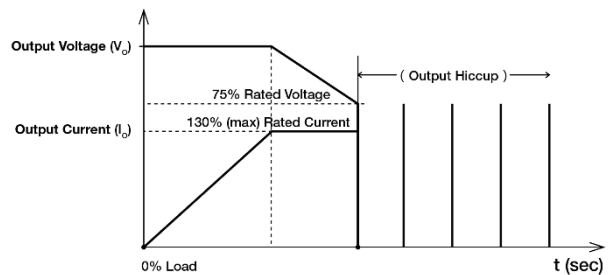

Fig. 8 Hiccup at OLP/OCP

Additionally, if the I_{out} is $>100\%$ for a prolong period of time (depending on the load), the Over Temperature Protection (OTP) may be activated due to high temperature on critical components. The power supply will then go into latch mode.

Short Circuit Protection

Output OLP/OCP function also provides protection against short circuits. When a short circuit is applied, the output current will operate in "Hiccup mode", The power supply will return to normal operation after the short circuit is removed.

Over Temperature Protection

As mentioned above, the power supply also has Over Temperature Protection (OTP). This is activated when the overload condition persists for an extended duration and the output current is below the overload trigger point but $>100\%$ load. In the event of a higher operating temperature condition at 100% load, the power supply will run into OTP when the surrounding air temperature is higher than the operating temperature. When activated, the output voltage will go into latch mode until the input voltage is removed; then, reapplied, and the surrounding air temperature drops to its normal operating temperature.

PMR Panel Mount Power Supply

PMR 1,500 W series / PMR-□V1K5W1BT□

Remote On/Off

Remote ON/OFF signal can be used to enable or disable the main output. When the main output is disabled, the +5 V Standby output will stop to operate. System can use a switch to conduct to disable the main output. The signal can be floated (no connection to the signal), in order to enable the main output.

SW OFF (open)	SW ON (close)
Power supply turn on	Power supply turn off

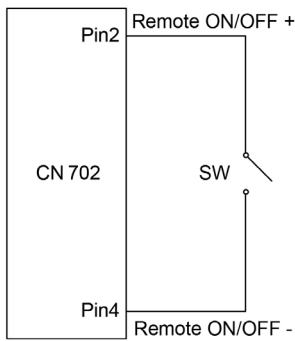

Fig. 9 Remote On/Off Control

Voltage Adjustment

The power supply provides a potentiometer for user to adjust the output voltage. The output voltage is designed to be able to adjust up to $\pm 10\%$ of rated voltage, when the output is adjusted below nominal value, the maximum output current is the same as the nominal output, when the output is adjusted above nominal value, the output power cannot exceed the nominal maximum power (the maximum output current will be reduced accordingly).

Current Sharing

The power supply supports parallel current sharing function. Two power supply main outputs are connected in parallel and connected. The Current Share port can enable this function (Pin 13 of CN602, refer to the power structure diagram and lead Foot definition), up to six power supplies can be connected in parallel.

When the power supply is connected in parallel, adjust the voltage difference between different power supplies to within ± 150 mV, and ensure that the maximum output current does not exceed 80% of the rated current.

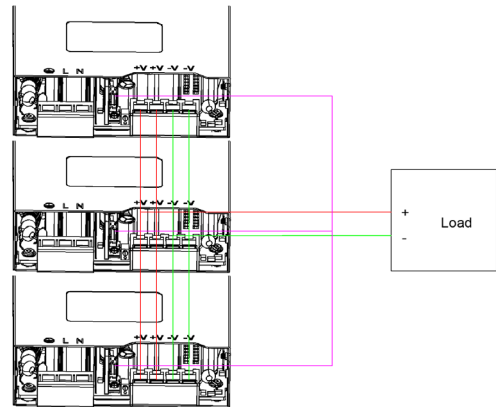

Fig. 10 Parallel Connection

PMR Panel Mount Power Supply

PMR 1,500 W series / PMR-□V1K5W1BT□

Peak Power

Peak Power (P_{pk}) is the reserve power available constantly that allows reliable startup to support sudden and short spike of loads with high inrush current typically during turn on to remove the need of more expensive higher rated power supply unit.

After the output has reached its steady state set value, the power supply can support surge loads with a higher short-term power demand up to P_{pk} , for a maximum duration of 3 seconds. If it exceeds 3 seconds, it will restart.

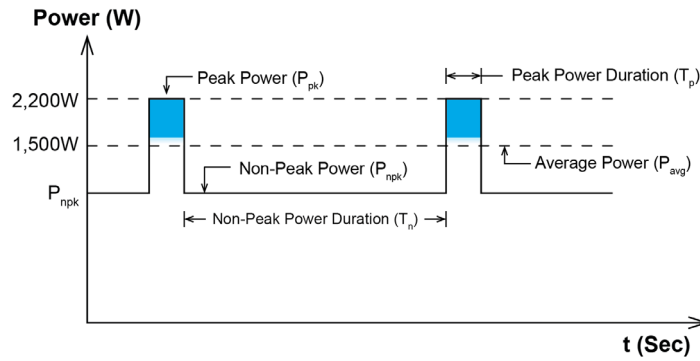

$$\text{Duty cycle (\%)} = \frac{T_p}{\text{Total Time}} ; (T_p \leq 3 \text{ sec})$$

$$\text{Average Output Power } (P_{avg}) = \frac{(P_{pk} \times T_p) + (P_{npk} \times T_n)}{\text{Total Time}}$$

OR

$$\text{Non-Peak Power } (P_{npk}) = \frac{(P_{avg} \times \text{Total Time}) - (P_{pk} \times T_p)}{T_n}$$

Peak Power (%)	Peak Power (P_{pk})	Peak Power Duration (T_p)	Duty Cycle	Non-Peak Power (P_{npk})	Non-Peak Power Duration (T_n)	Total Time (T)
147%	2,200W	3 sec	37.5%	1,080W	5 sec	8 sec

Fig. 11 Duty Cycle Calculation

PMR Panel Mount Power Supply

PMR 1,500 W series / PMR-□V1K5W1BT□

Attention

Delta provides all information in the datasheets on an "AS IS" basis and does not offer any kind of warranty through the information for using the product. In the event of any discrepancy between the information in the catalog and datasheets, the datasheets shall prevail (please refer to www.DeltaPSU.com for the latest datasheets information). Delta shall have no liability of indemnification for any claim or action arising from any error for the provided information in the datasheets. Customer shall take its responsibility for evaluation of using the product before placing an order with Delta.

Delta reserves the right to make changes to the information described in the datasheets without notice.

Manufacturer and Authorized Representatives Information

Manufacturer

Thailand

Delta Electronics (Thailand) PCL.
909 Pattana 1 Rd., Muang, Samutprakarn, 10280 Thailand

Taiwan

Delta Electronics, Inc.
3 Tungyuan Road, Chungli Industrial Zone, Taoyuan County
32063, Taiwan

Authorized Representatives

The Netherlands

Delta Greentech (Netherlands) B.V.
Zandsteen 15, 2132 MZ Hoofddorp, The Netherlands

United Kingdom

Delta Electronics Europe Limited
1 Redwood Court, Peel Park Campus,
East Kilbride, Glasgow, G74 5PF, United Kingdom