

LNE

LNE LED Driver

36V 187.2W 1 Phase / LNE-36V185WACA

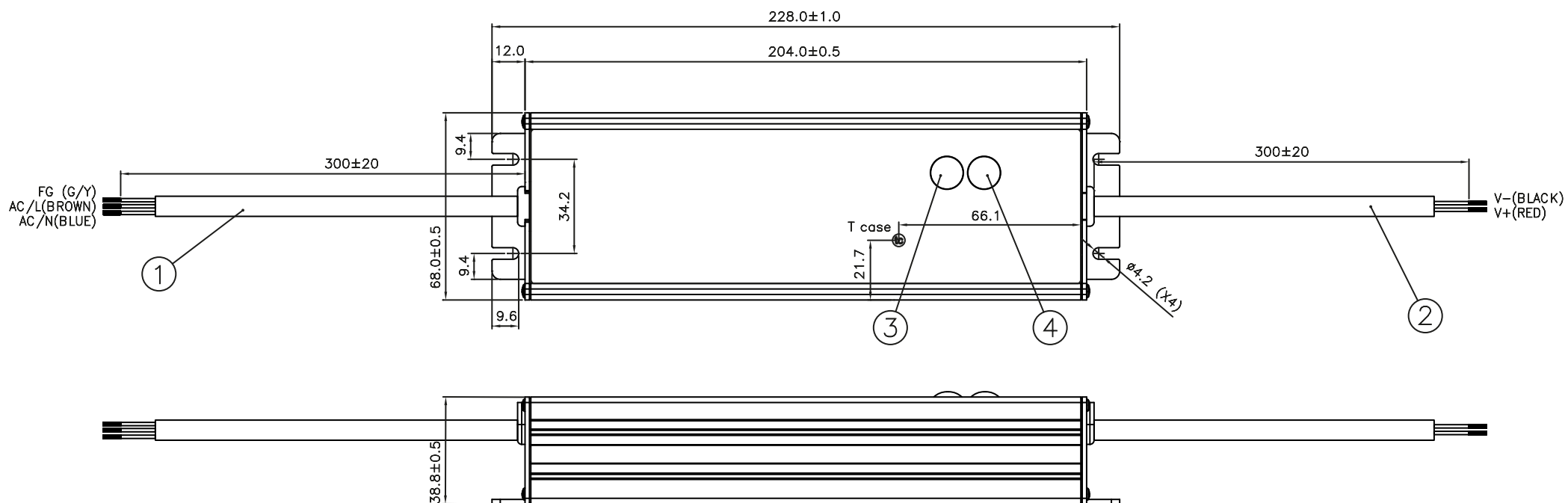

Item	Device Description
1	Input Cable
2	Output Cable
3	Vo Adjust (Constant Voltage Adjustment)
4	Io Adjust (Constant Current Adjustment)
tc	T case (tc): Temperature hot spot location on case.

LNE

LNE LED Driver

36V 187.2W 1 Phase / LNE-36V185WAAA

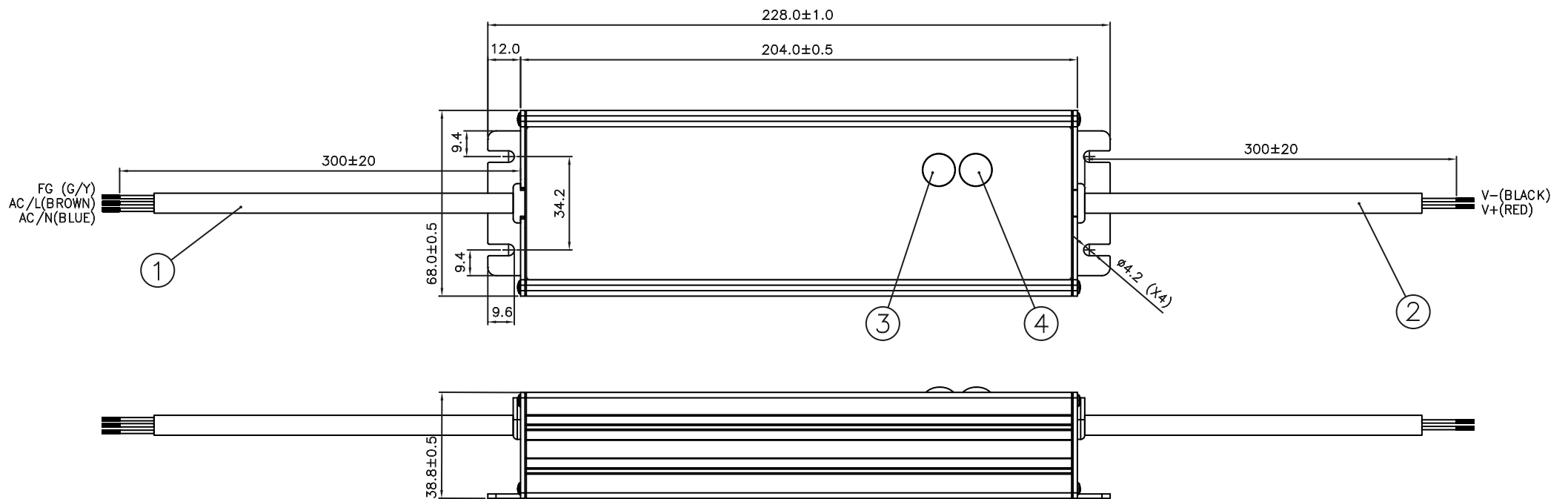

Item	Device Description
1	Input Cable
2	Output Cable
3	Vo Adjust (Constant Voltage Adjustment)
4	Io Adjust (Constant Current Adjustment)

LNE

LNE LED Driver

36V 187.2W 1 Phase / LNE-36V185WDCA

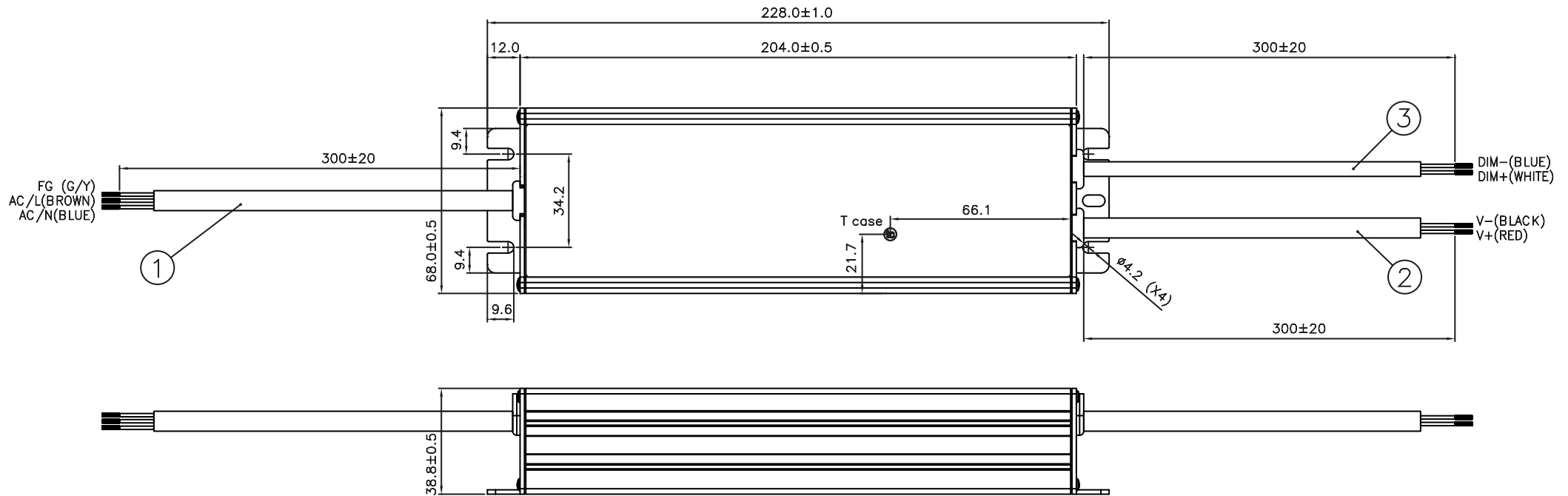

Item	Device Description
1	Input Cable
2	Output Cable
3	Dimming Cable
tc	T case (tc): Temperature hot spot location on case.

LNE

LNE LED Driver

36V 187.2W 1 Phase / LNE-36V185WDAA

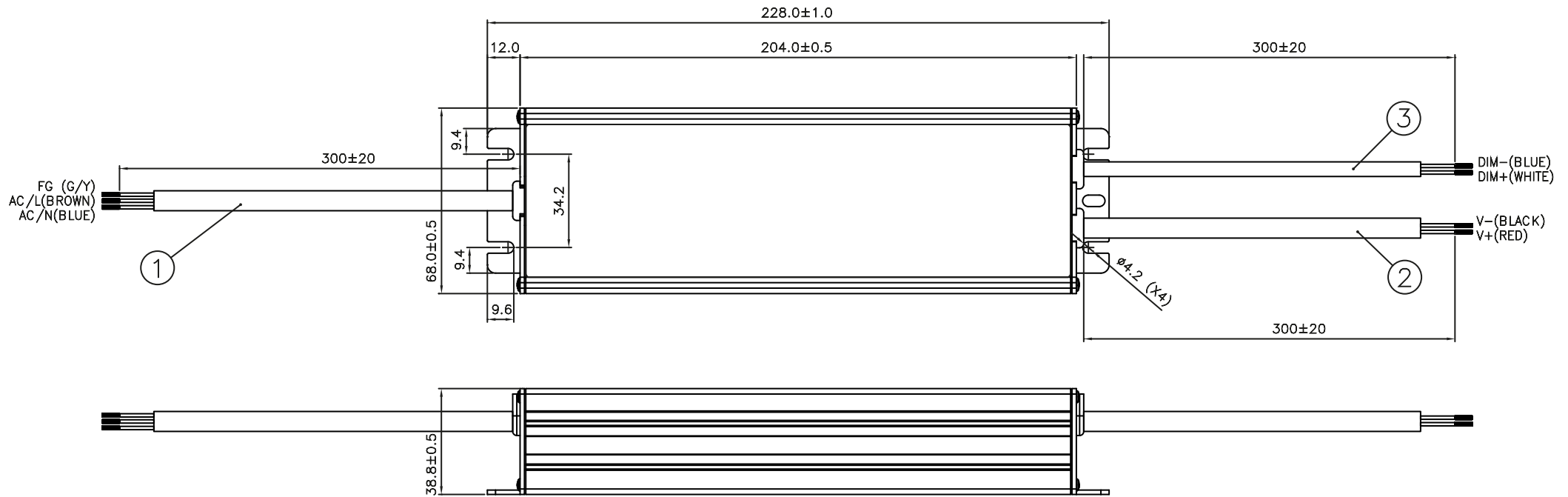

Item	Device Description
1	Input Cable
2	Output Cable
3	Dimming Cable