

Medical / Industrial AC-DC Configurable Power Supply

Up to 2100W / MEG-A series



PLEASE READ AND FULLY UNDERSTAND THIS APPLICATION NOTE BEFORE UNPACK AND INSTALL THE POWER SUPPLY

Medical / Industrial AC-DC Configurable Power Supply

Up to 2100W / MEG-A series

Highlight & Features



- Up to 2100 W in 5"x10"x1.59" Package for MEG-2K1A
- Up to 1200 W in 3.5"x10"x1.59" Package for MEG-1K2A
- Full Power up to 50° C Ambient
- Up to 500 kHrs MTBF
- 2 X MOPP Isolation for Medical Application
- Output selectable from 2 V to 60 V
- Current sharing
- Class B Conducted and Radiated EMI
- IEC60601-1-2 4th edition immunity compliance
- Normal and Reversed Option for Global Remote On/Off & Air Flow Direction without power de-rating
- Analog and Digital Voltage Trimming
- PMBus Ver 1.3 Supported
- Intelligent Fan Speed Control
- Optional RS485/RS232/USB Communication Adapters
- PC GUI for easy parameter setting and monitoring

1 General Safety Information

In the user manual, contains four kinds of safety tips: DANGER, WARNING, CAUTION and NOTE. Before reading this manual, you must have a fully understanding of these safety tips.

Safety tips are defined as follows:



If described event is unavoidable, it will cause serious physical injury or death to service engineer, operator, patient, or other personnel.



If described event is unavoidable, it will be occurred serious physical injury for service engineer, operator, patient or other personnel, or catastrophic damage for the power supply or any electronic devices connected to the power supply, or to lose important data or system operation chaos.



If described event is unavoidable, it will be occurred physical injury for service engineer, operator, patient or other personnel, or damage the power supply or any electronic devices connected to the power supply, or to lose data or system operation chaos.



If described event is unavoidable, it will be provided to alert relevant personnel who can contact with the power supply that serious injury will result if the hazard identified is ignored.

Medical / Industrial AC-DC Configurable Power Supply

Up to 2100W / MEG-A series

1.1 Safety Instructions

Installation:

Requirements of IEC60601-1 3rd+A1/EN 60601-1: 2006+A11+A12+A1 shall be observed during the installation in the final system. The products are intended for build in use in the final Class I system and to avoid risk of electric shock, products must only be connected to a supply mains with protective earth. The PSU has double fuses on line and neutral input, rating is 20A/250Vac for MEG-2K1A series and 16A/250Vac for MEG-1K2A series, comply with IEC-60127.

Servicing:

Instructions or reference information for repair of equipment parts are provided by the manufacturer. Please contact us for this information. Do not modify the product without authorization from Delta.

Critical Components:

These products are not authorized for use as critical components in nuclear control systems, life support systems or equipment for use in hazardous environments without the express written management approval from Delta.

Product Usage:

These products are designed to apply in medical, industrial, commercial and IT equipment which need to use DC voltages.

Environmental:

These products are IPX0, and therefore chemical/solvents, cleaning agents and other liquids must not be used. They shall be operated in dry locations to protect from moisture and are not suitable for using in an oxygen rich environment.

Environment:

This power supply is a switch mode power supply for use in applications within a Pollution Degree 2, overvoltage category II environment. Material Group IIIb PCB is used. The maximum operating altitude is 5000m. The working/storage environment is listed below.

Surrounding Air Temperature	Operating	Absolute Maximum/Minimum Rating. -20°C to +70°C. Refer to detailed linearly power de-rating curves on page 29&30.
	Storage	-40°C to +85°C
Operating Humidity		5-95% RH (Non-Condensing)

Input Parameters:

This product must be operated within the input parameters stated in the product limitations in this user manual.

Output Loading:

The power supply output power taken must not exceed the rating that is stated on label of the power supply, except as stated in the product limitations in this user manual.

Repair/ Maintenance:

Instructions or reference information for repair of equipment parts are provided by the manufacturer. Please contact us for this information.







End of Life Disposal:

The power supply contains components that require special disposal. The instructions shall be according to IEC60601-1:2005, clause 7.9.2.15 and 7.9.3.1. For end of life cycle, make sure that the power supply doesn't throw into general trash, and it must be handed over to the local recycle system.

Medical / Industrial AC-DC Configurable Power Supply

Up to 2100W / MEG-A series

1.2 Warning

NOTE	There's no practical design can incorporate protection for operators or service personnel who do not take adequate safety precautions. Only authorized, qualified, properly trained personnel and operating personnel are allowed to work with the power supply. The appropriate personnel must be aware of the inherent dangers / hazardous associated with the servicing of power supply contains hazardous high voltage.
	There are double pole/neutral fusing inside the power supply
	The power supply has sharp metal edge, pay attention to this before installation to avoid injury.
	It is the power supply user's responsibility to use and operate the power supply in proper way for functionality and safety. Although Delta Electronics provides information for the power supply and potential hazards, but Delta Electronics assumes no responsibility for use and operating the power supply after sale. Delta Electronics assumes no responsibility if the power supply is not installed according this manual. Delta Electronics assumes no responsibility if the power supply is not correctly maintained according this manual. Delta Electronics assumes no responsibility for any if the power supply is modified in any way after sale.
	It is not allowed to disassemble the power supply without Delta's technical support or authorization, to avoid the injury by high voltage.
	Please take all required preventive measures with related hazards if any cover must be removed. When the need of removal is completed, please replace the covers immediately.
	Hazardous voltage exists inside the power supply whenever the AC main power is connected to the power supply. Moreover, hazardous voltage will continue to exist even after the power supply is disconnected from the AC input voltage after a certain period of time. This hazardous voltage exists in but not limited to following parts: Fuse, Fuse holder, Main Relay, Bridge rectifier, Bulk Capacitors, Main Power Circuits, Associated circuits on power input board, etc. Although bleeding resistors are added for energy stored capacitor to discharge after AC off, due to the possibility of component fault, the bleeding functionality may not work. Calibrated measurement equipment, for example, voltage meter, must be used to measure voltage to confirm it is within safe voltage range before access the parts.

Medical / Industrial AC-DC Configurable Power Supply

Up to 2100W / MEG-A series

2 General Overview

2.1 General Description

The MEG-A series of internal built power supplies come with universal AC input range from 90Vac to 264Vac. It can configure multiple outputs using series of different output models in one package and fast deliver to end user, let user to focus on the end device design rather than designing the power supply. Other features include low leakage, and electric shock protection compliance with 2 x MOPP medical isolation requirements. The MEG-A series is certified for EMC standards according to EN 55011 for industrial, scientific and medical (ISM) radio-frequency equipment; and, EN 55032 for Industrial Technology Equipment (ITE) radio-frequency equipment. In addition, only recognized Japanese capacitors are used to ensure long product life.

The MEG-A series comes with both medical and ITE safety approvals, including UL/CE, and CB certification. Designs are compliant with RoHS Directive 2011/65/EU for environmental protection, to avoid risk of opening of a branch circuit breaker, the product is tested on a 50A type D branch circuit, if used on a different branch circuit, additional testing may be necessary.

The MEG-A series are also compliant with SEMI F47 tests to immunity voltage sag for semiconductor processing, metrology, and automated test equipment.

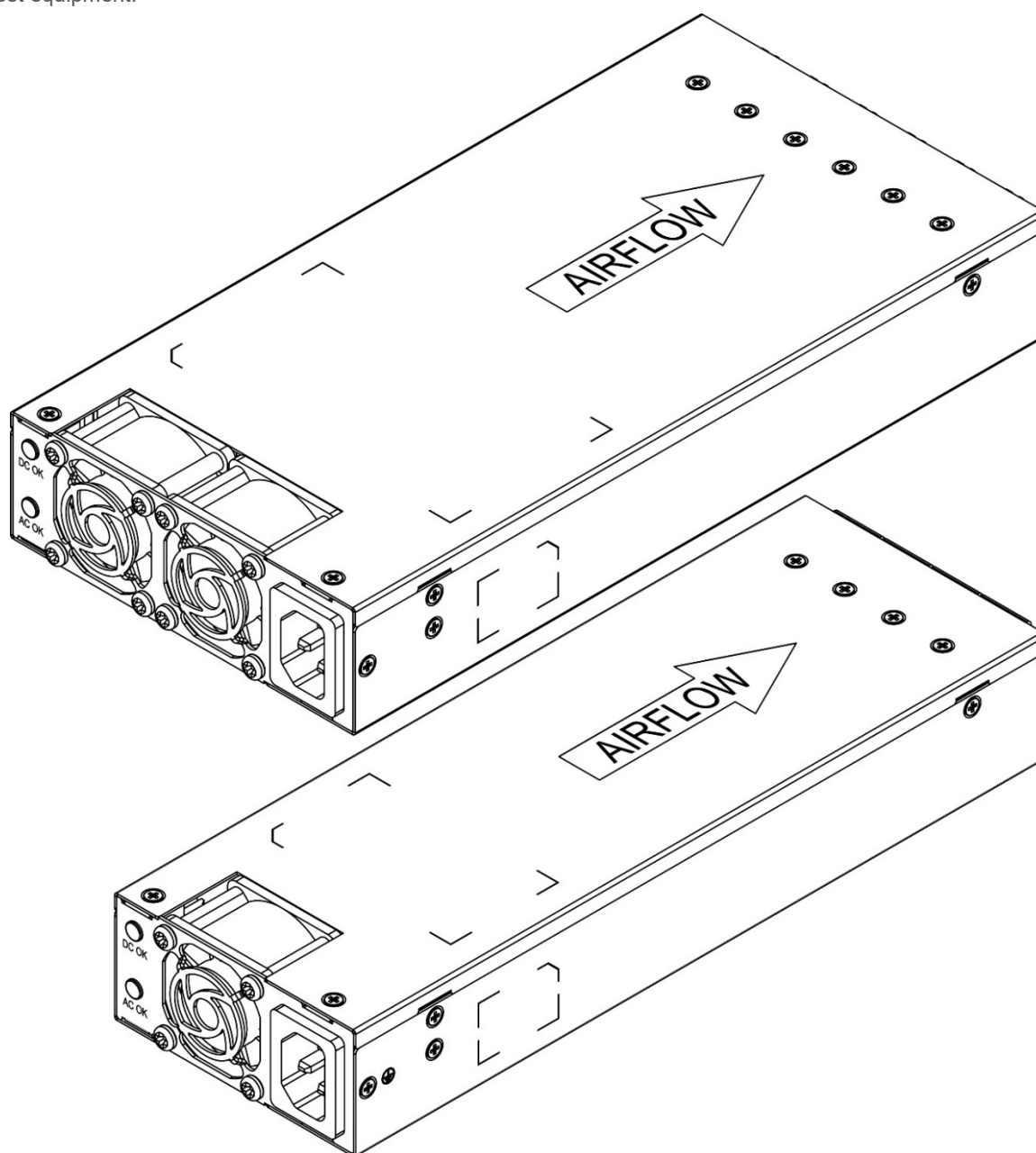

Fig. 1: MEG-2K1A series & MEG-1K2A series

Medical / Industrial AC-DC Configurable Power Supply

Up to 2100W / MEG-A series

2.2 Order Information

MEG	-	2K1		A		6		X		Y-Y-Y-Y		ZZZZZ
ME: Delta Medical Power Supply G: Configurable		Max Wattage in Product Series 2K1: 2,100 W 1K2: 1,200 W		Family Code A series		Slot Number 4: 4 Slots 6: 6 Slots		Inlet Type T: US Terminal E: EU Terminal C: C14		Output Configurations See below		PSU Configuration See below

	Power supply category	ME: Delta Medical grade power supply G: Configurable power supply
	Max Deliverable Power	2K1: 2100 W max power delivery capability 1K2: 1200 W max power delivery capability
	Family Code	
	Model Slots number	6: configurable power supply can use up to 6 slots max for configuration 4: configurable power supply can use up to 4 slots max for configuration
	Inlet Type	T: US Terminal E: EU Terminal C: C14 Socket Note: see mechanical drawing for detail
	Output configuration	For single output module, output module code combined with a voltage code and a current code. For dual output module, output module code is combined with two voltage code. Please check Table 1 for all available combinations. For example: J1: 12 V, 25 A, single slot, single output module. O2: 24 V, 50 A, triple slot, single output module. OJ: Dual output module, one 24 V/4 A output, one 12 V/5 A output. Split the modules with a "-". If any slot to be left empty, use code "NU".
	PSU configuration	1 st digit Parallel code, see Table 2 for detail 2 nd digit Control Code 0: Normal Logic & Normal Fan Direction 1: Reversed Logic & Normal Fan Direction 2: Normal Logic & Reversed Fan Direction 3: Reversed Logic & Reversed Fan Direction 3 rd digit Communication code 0: Default PMBus 1: RS232 adapter 2: USB adapter 3: RS485 adapter 4-5th digit CC revision code Use AA for standard default

Medical / Industrial AC-DC Configurable Power Supply

Up to 2100W / MEG-A series

2.2.1 Output Modules

Table 1. Voltage Code

Voltage Code		Current Code					
		Single Slot Module		Triple Slot Module ¹⁾		Single Slot Dual Output Module ¹⁾	
		1		2			
Code	Voltage	Current	Power	Current	Power	V1 or V2 Current	V1 or V2 Power
A	2.0 V	45.0 A	90 W	-	-	-	-
B	2.4 V	45.0 A	108 W	-	-	-	-
C	3.0 V	45.0 A	135 W	-	-	-	-
D	3.3 V	45.0 A	149 W	-	-	5.0 A	16.5 W
E	5.0 V	45.0 A	225 W	-	-	5.0 A	25 W
F	5.5 V	45.0 A	248 W	-	-	5.0 A	27.5 W
G	6.0 V	42.0 A	252 W	-	-	5.0 A	30 W
H	8.0 V	25.0 A	200 W	100.0 A	800 W	5.0 A	40 W
I	10.0 V	25.0 A	250 W	100.0 A	1000 W	5.0 A	50 W
J	12.0 V	25.0 A	300 W	100.0 A	1200 W	5.0 A	60 W
K	14.0 V	21.4 A	300 W	85.7 A	1200 W	5.0 A	70 W
L	15.0 V	20.0 A	300 W	73.3 A	1100 W	5.0 A	75 W
M	18.0 V	16.7 A	300 W	61.1 A	1100 W	5.0 A	90 W
N	20.0 V	15.0 A	300 W	53.0 A	1060 W	5.0 A	100 W
O	24.0 V	12.5 A	300 W	50.0 A	1200 W	4.0 A	96 W
P	28.0 V	10.7 A	300 W	42.8 A	1200 W	4.0 A	112 W
Q	30.0 V	10.0 A	300 W	33.3 A	1000 W	4.0 A	120 W
R	32.0 V	9.4 A	300 W	34.4 A	1100 W	-	-
S	36.0 V	8.3 A	300 W	33.3 A	1200 W	-	-
T	42.0 V	7.1 A	300 W	28.6 A	1200 W	-	-
U	48.0 V	6.3 A	300 W	25.0 A	1200 W	-	-
V	54.0 V	5.5 A	300 W	22.2 A	1200 W	-	-
W	60.0 V	5.0 A	300 W	20.0 A	1200 W	-	-

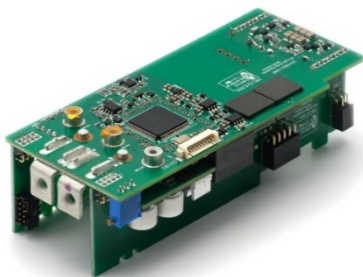

Medical / Industrial AC-DC Configurable Power Supply

Up to 2100W / MEG-A series

Series	Voltage	Output Min.	Output Max.	Current	Power	No. of O/P	Customer Code
Single Slot Module	2.0 V	2.00 V	2.20 V	45.0 A	90 W	S:Single	A1
	2.4 V	2.16 V	2.70 V	45.0 A	108 W	S:Single	B1
	3.0 V	2.70 V	3.30 V	45.0 A	135 W	S:Single	C1
	3.3 V	2.97 V	4.00 V	45.0 A	149 W	S:Single	D1
	5.0 V	4.00 V	5.50 V	45.0 A	225 W	S:Single	E1
	5.5 V	4.95 V	6.05 V	45.0 A	248 W	S:Single	F1
	6.0 V	5.40 V	7.00 V	42.0 A	252 W	S:Single	G1
	8.0 V	7.00 V	9.00 V	25.0 A	200 W	S:Single	H1
	10.0 V	9.00 V	11.0 V	25.0 A	250 W	S:Single	I1
	12.0 V	10.8 V	13.2 V	25.0 A	300 W	S:Single	J1
	14.0 V	12.6 V	14.0 V	21.4 A	300 W	S:Single	K1
	15.0 V	13.5 V	16.5 V	20.0 A	300 W	S:Single	L1
	18.0 V	16.2 V	19.8 V	16.7 A	300 W	S:Single	M1
	20.0 V	18.0 V	22.0 V	15.0 A	300 W	S:Single	N1
	24.0 V	21.6 V	26.4 V	12.5 A	300 W	S:Single	O1
	28.0 V	25.2 V	28.0 V	10.7 A	300 W	S:Single	P1
	30.0 V	27.0 V	33.0 V	10.0 A	300 W	S:Single	Q1
	32.0 V	28.8 V	35.2 V	9.40 A	300 W	S:Single	R1
	36.0 V	32.4 V	39.6 V	8.30 A	300 W	S:Single	S1
	42.0 V	37.8 V	42.0 V	7.10 A	300 W	S:Single	T1
48.0 V	42.0 V	52.8 V	6.30 A	300 W	S:Single	U1	
54.0 V	48.6 V	59.4 V	5.50 A	300 W	S:Single	V1	
60.0 V	54.0 V	60.0 V	5.00 A	300 W	S:Single	W1	

Medical / Industrial AC-DC Configurable Power Supply

Up to 2100W / MEG-A series

Series	Voltage	Output Min.	Output Max.	Current	Power	No. of O/P	Customer Code
Triple Slot Module	8.0 V	7.0 V	10.0 V	100.0 A	800 W	S:Single	H2
	10.0 V	10.0 V	11.0 V	100.0 A	1000 W	S:Single	I2
	12.0 V	10.8 V	13.2 V	100.0 A	1200 W	S:Single	J2
	14.0 V	12.6 V	14.0 V	85.7 A	1200 W	S:Single	K2
	15.0 V	14.0 V	16.5 V	73.3 A	1100 W	S:Single	L2
	18.0 V	16.2 V	20.0 V	61.1 A	1100 W	S:Single	M2
	20.0 V	20.0 V	22.0 V	53.0 A	1060 W	S:Single	N2
	24.0 V	21.6 V	26.4 V	50.0 A	1200 W	S:Single	O2
	28.0 V	25.2 V	28.0 V	42.8 A	1200 W	S:Single	P2
	30.0 V	28.0 V	33.0 V	33.3 A	1000 W	S:Single	Q2
	32.0 V	28.8 V	35.2 V	34.4 A	1100 W	S:Single	R2
	36.0 V	32.4 V	39.6 V	33.3 A	1200 W	S:Single	S2
	42.0 V	37.8 V	42.0 V	28.6 A	1200 W	S:Single	T2
	48.0 V	42.0 V	52.8 V	25.0 A	1200 W	S:Single	U2
	54.0 V	48.6 V	59.4 V	22.2 A	1200 W	S:Single	V2
60.0 V	54.0 V	60.0 V	20.0 A	1200 W	S:Single	W2	

Series	Voltage	Output Min.	Output Max.	Current	Power	No. of O/P	Customer Code
Single Slot Dual Output Module	3.3 V	2.97 V	4.00 V	5.0 A	16.5 W	D: Dual	D
	5.0 V	4.00 V	5.50 V	5.0 A	25.0 W	D: Dual	E
	5.5 V	4.95 V	6.05 V	5.0 A	27.5 W	D: Dual	F
	6.0 V	5.40 V	7.00 V	5.0 A	30.0 W	D: Dual	G
	8.0 V	7.00 V	9.00 V	5.0 A	40.0 W	D: Dual	H
	10.0 V	9.00 V	11.0 V	5.0 A	50.0 W	D: Dual	I
	12.0 V	10.8 V	13.2 V	5.0 A	60.0 W	D: Dual	J
	14.0 V	12.6 V	15.4 V	5.0 A	70.0 W	D: Dual	K
	15.0 V	13.5 V	16.5 V	5.0 A	75.0 W	D: Dual	L
	18.0 V	16.2 V	19.8 V	5.0 A	90.0 W	D: Dual	M
	20.0 V	18.0 V	22.0 V	5.0 A	100.0 W	D: Dual	N
	24.0 V	21.6 V	26.4 V	4.0 A	96.0 W	D: Dual	O
	28.0 V	25.2 V	30.0 V	4.0 A	112.0 W	D: Dual	P
30.0 V	27.0 V	30.0 V	4.0 A	120.0 W	D: Dual	Q	

Medical / Industrial AC-DC Configurable Power Supply

Up to 2100W / MEG-A series

2.2.2 Parallel Code

Parallel feature is available for the same output modules. Select parallel code, Delta will parallel the outputs before shipping to customer. Parallel feature is designed for single slot modules and only two modules can be paralleled. Triple slot modules and dual output module cannot support this option. Please notes that trimming the paralleled output voltage through potentiometer is forbidden on customer side. If customers need to adjust output voltage after paralleling modules, please consult Delta for support.

Table 1. Parallel Code

Code	1	2	3	4	5	6
0	No Parrallel					
A	■					
B		■				
C			■			
D				■		
E					■	
F	■		■			
G	■			■		
H	■				■	
I	■		■		■	
J		■		■		
K		■			■	
L			■		■	

2.2.3 Order Examples

MEG-1K2A4T J1-J1-O1-C1 A00AA

4 Slots, US Terminal type input, two 12V modules in parallel, one 24V module, one 3V module

MEG-2K1A6C J1-J1-J1-O1-O1-KP 011AA

6 Slots, C14 inlet, three 12V module, two 24V module, one dual output module with 14V and 28V output, no parallel, reversed logic, with optional RS232 control module

MEG-1K2A4E O2-KP 000AA

4 Slots, European Terminal type input, one triple slot 24V module, one dual output module with 14V and 28V output

MEG-2K1A6C J2-O1-O1-NU D00AA

6 Slots, C14 inlet, one triple slot 12V module, two 24V modules in parallel, Slot 6 left empty.

Medical / Industrial AC-DC Configurable Power Supply

Up to 2100W / MEG-A series

2.3 Installation Instruction

The Installer Requirement:

- Must have necessary electric knowledge and understand the risks of electric shock;
- Must read the safety warning from section 1.1-1.2 carefully
- Must fully understand the connections in 2.2 before installation.

2.3.1 Mounting Orientations

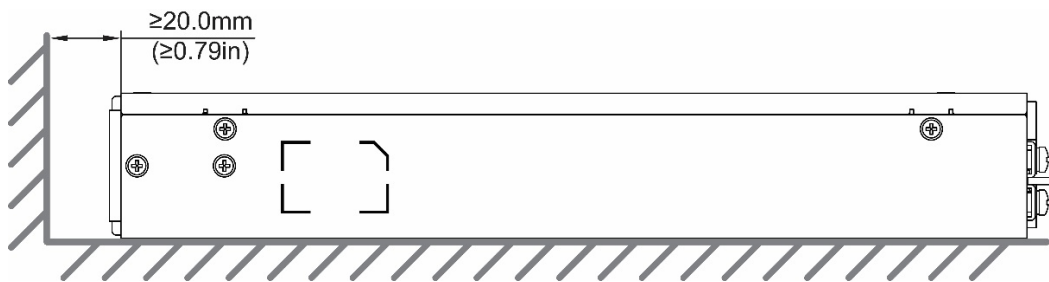

Fig. 2: Standard mounting orientation

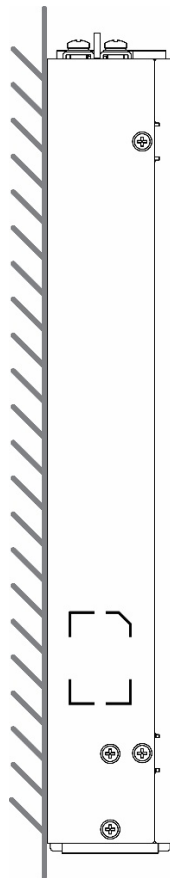

Fig. 3: Vertical mounting

Medical / Industrial AC-DC Configurable Power Supply

Up to 2100W / MEG-A series

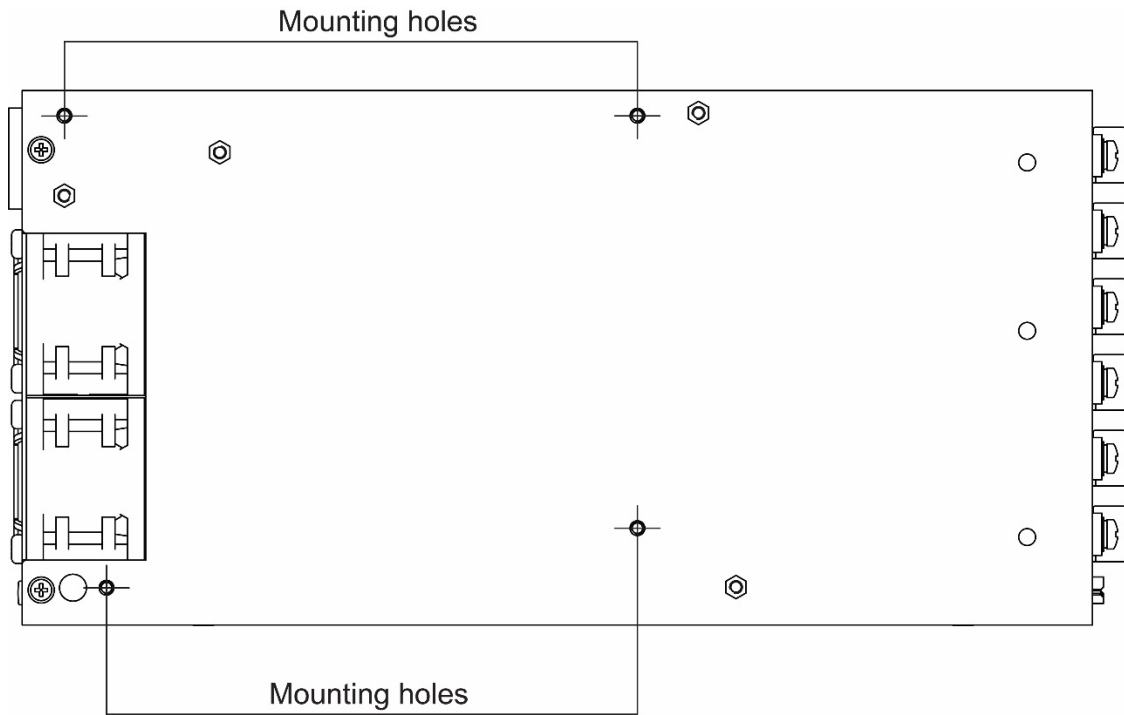

Fig. 4: Position of mounting holes

Note: Always keep ≥ 20 mm (0.79 in) space on the fan side and on the connector side to ensure proper airflow.

Medical / Industrial AC-DC Configurable Power Supply

Up to 2100W / MEG-A series

2.3.2 MEG-A Series Mechanical Outlines

MEG-2K1A6 (2100 Watts Max.)

Case Size: MEG-2K1A6:10.0" x 5.0" x 1.59" (254.0mm x 127.0mm x 40.5mm)

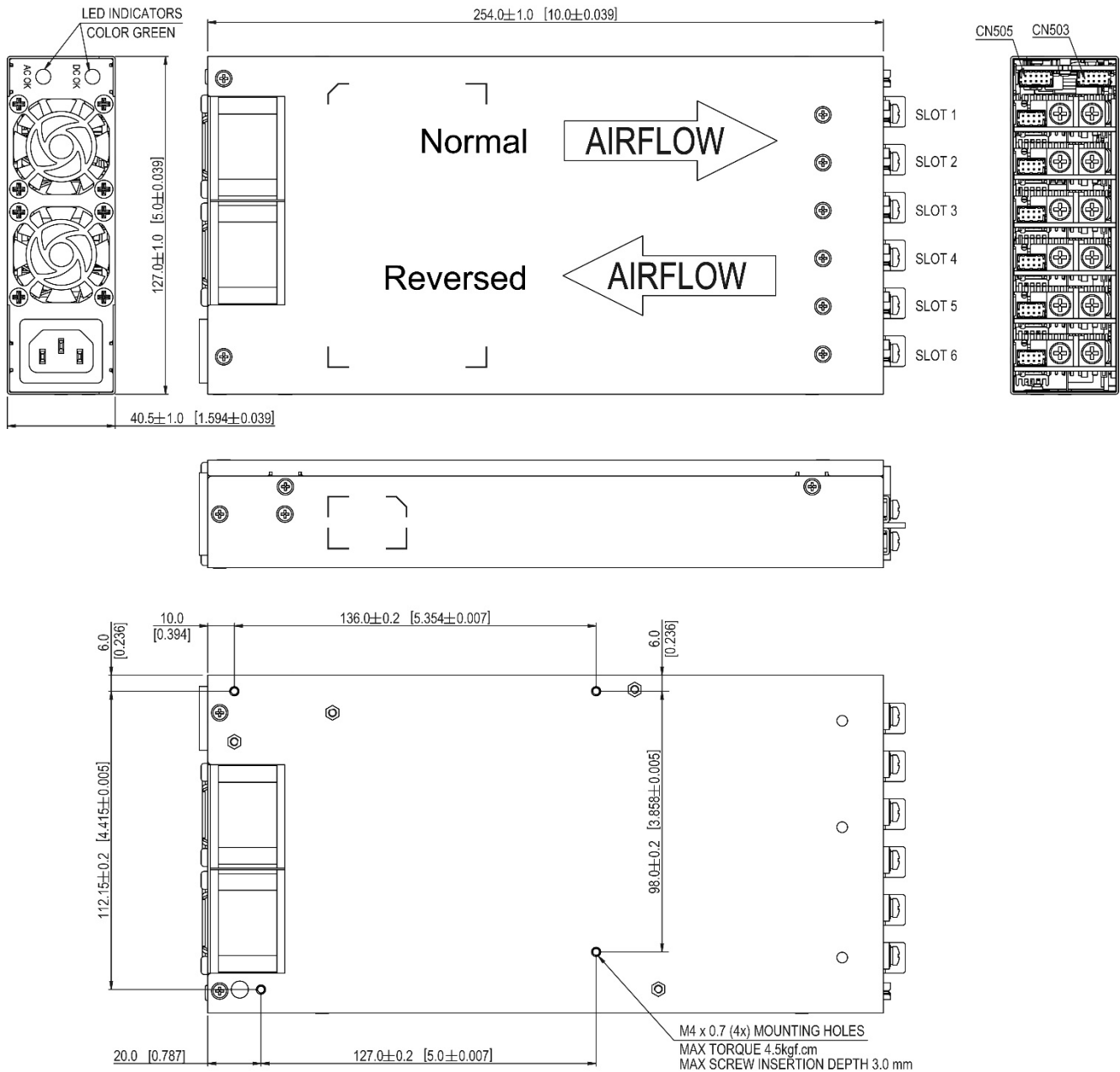

Fig. 5: Dimensional drawing MEG-2K1A

Note:

1. Output Module Connectors: All single O/P modules are M4 x 8 mm screws, tighten between 7.0 to 10.0 kgf.cm (6.08 to 8.68 lbf.in); Dual O/P module is PUSH IN conductor connector; Wire Strip Length: 0.315" - 0.354" (8.0 - 9.0 mm).
2. Case Material: SGCC (conductive).
3. Customer Mounting: Screw M4-type mounting holes; Max. Penetration is 3.0 mm (0.118"); Max. Torque: 4.5 kgf.cm (3.91 lbf.in)
4. Adjustable VR clockwise is to increase the output voltage.
5. All dimensions are in millimeters and inches.

Medical / Industrial AC-DC Configurable Power Supply

Up to 2100W / MEG-A series

MEG-1K2A4 (1200 Watts Max.)

Case Size: MEG-1K2A4:10.0" x 3.5" x 1.59" (254.0mm x 88.9mm x 40.5mm)

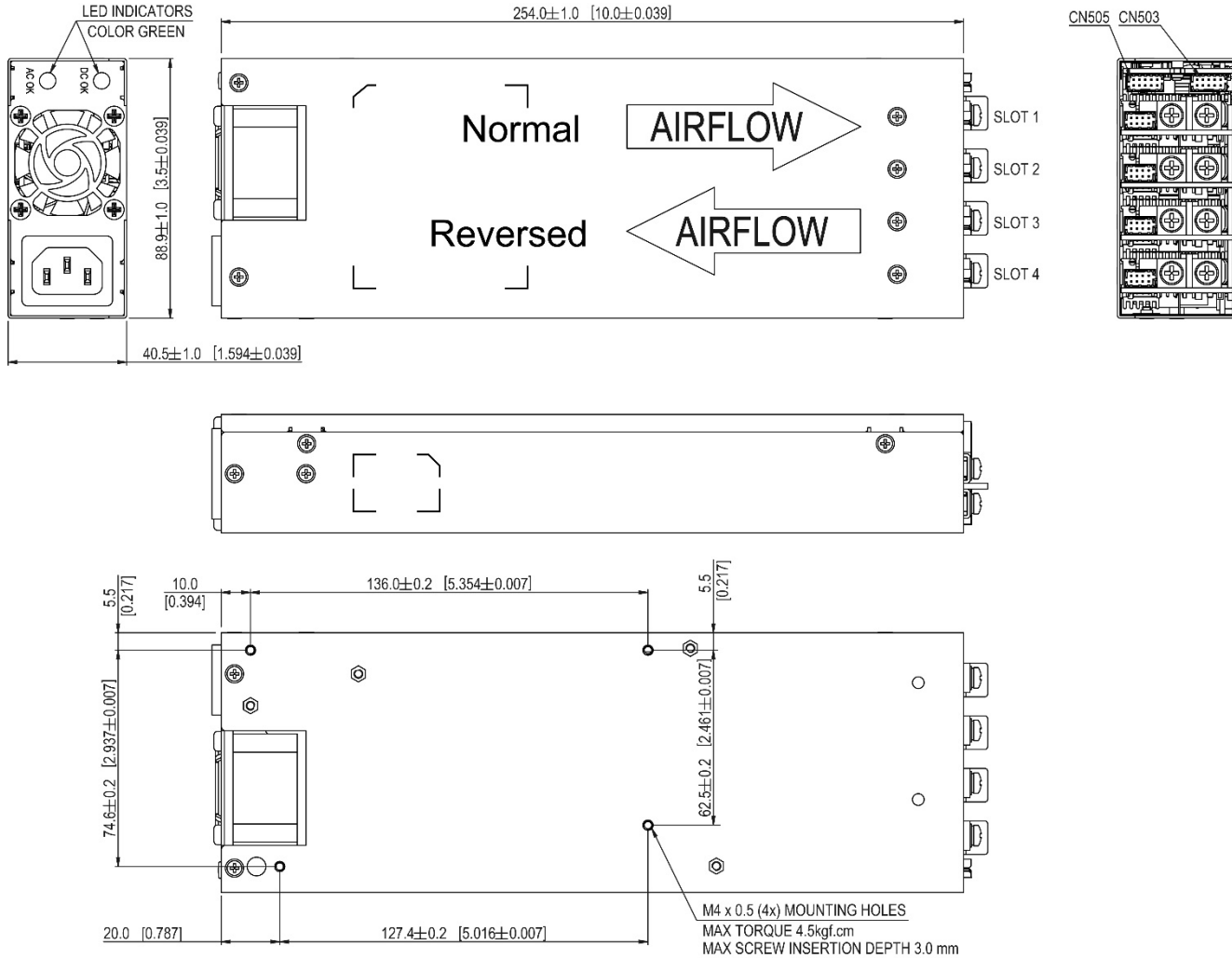

Fig. 6: Dimensional drawing MEG-1K2A

Note:

1. Output Module Connectors: All single O/P modules are M4 x 8 mm screws, tighten between 7.0 to 10.0 kgf.cm (6.08 to 8.68 lbf.in); Dual O/P module is PUSH IN conductor connector; Wire Strip Length: 0.315" - 0.354" (8.0 - 9.0 mm).
2. Case Material: SGCC (conductive).
3. Customer Mounting: Screw M4-type mounting holes; Max. Penetration is 3.0 mm (0.118"); Max. Torque: 4.5 kgf.cm (3.91 lbf.in)
4. Adjustable VR clockwise is to increase the output voltage.
5. All dimensions are in millimeters and inches.

Medical / Industrial AC-DC Configurable Power Supply Up to 2100W / MEG-A series

MEG-A300M Series - Single Slot Single Output Module

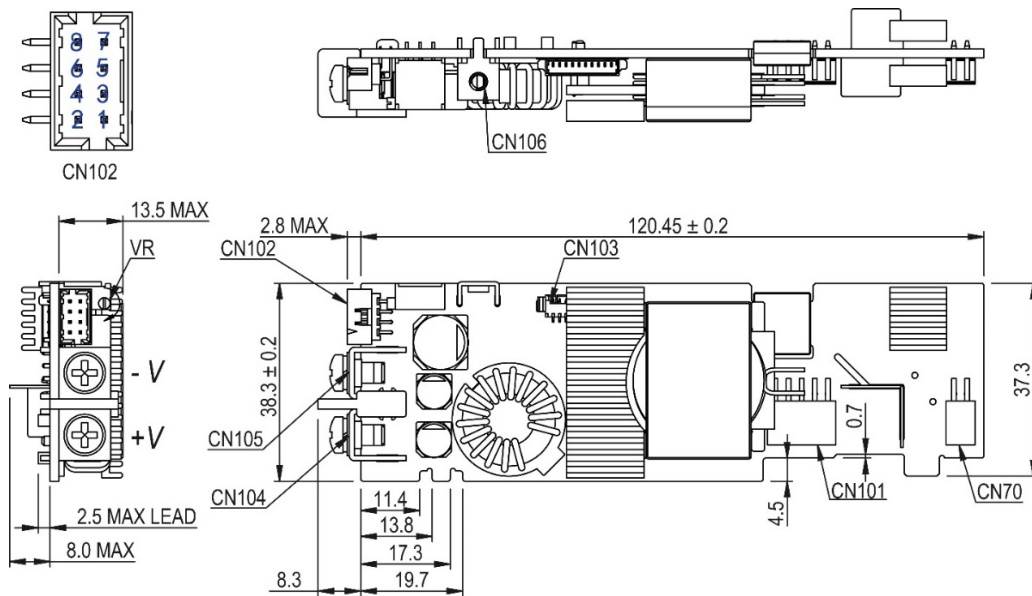

Fig. 7: Dimensional drawing Single Slot Module

Medical / Industrial AC-DC Configurable Power Supply Up to 2100W / MEG-A series

MEG-A1K2M Series - Triple Slot Single Output Module

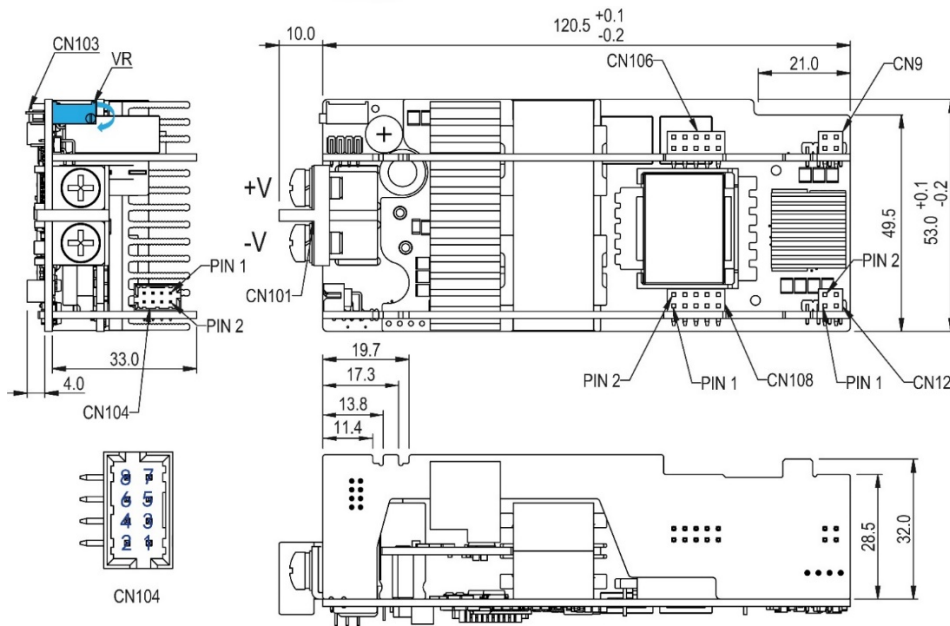
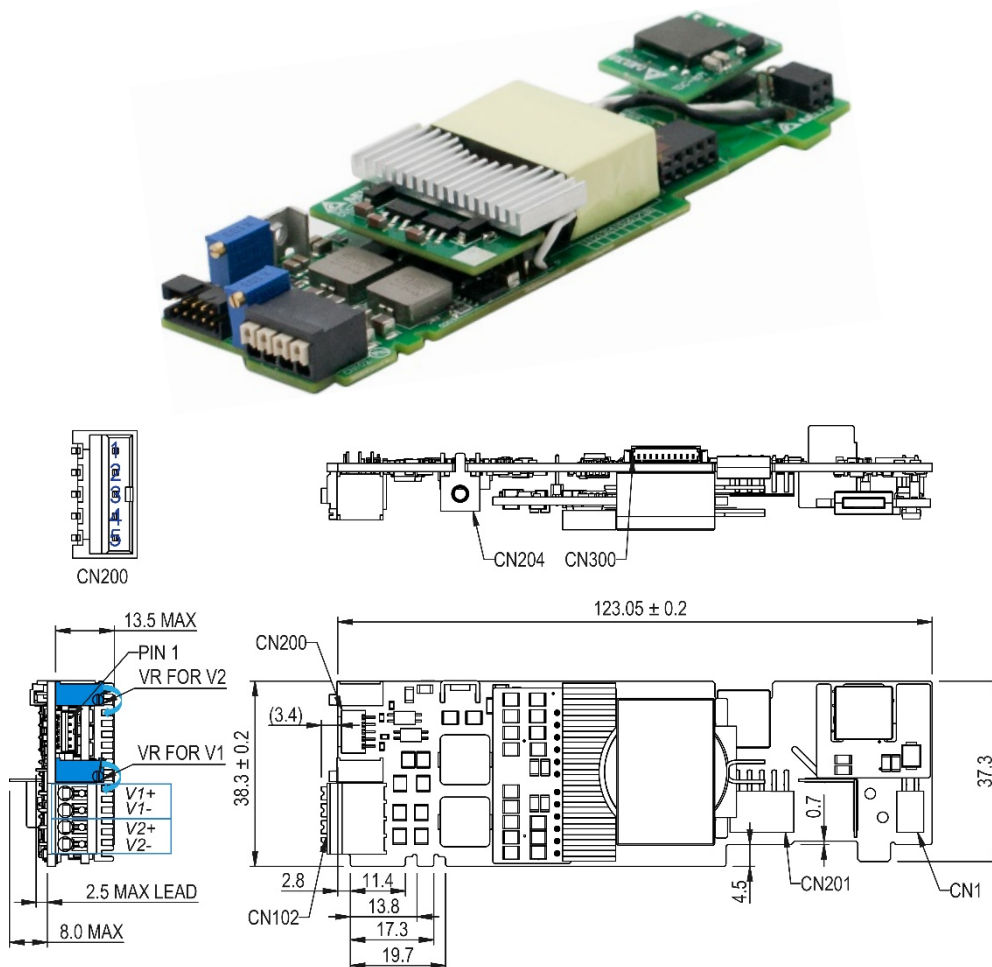

Fig. 8: Dimensional drawing Triple Slot Module

Medical / Industrial AC-DC Configurable Power Supply Up to 2100W / MEG-A series

MEG-A240M Series - Single Slot Dual Output Module



Medical / Industrial AC-DC Configurable Power Supply

Up to 2100W / MEG-A series

2.3.3 AC Inlet Type Option

“C”

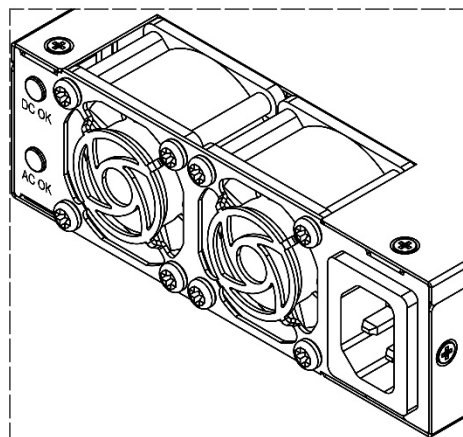

Figure 10. IEC320-C14

CONDUCTOR SIZE: 14 - 18 AWG

“E”

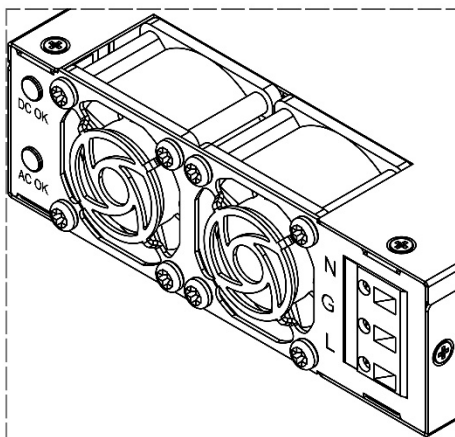

Figure 11. European Terminal Block

CONDUCTOR SIZE: 14 - 18 AWG
TIGHTENING TORQUE: 2.76 kgf.cm

“T”

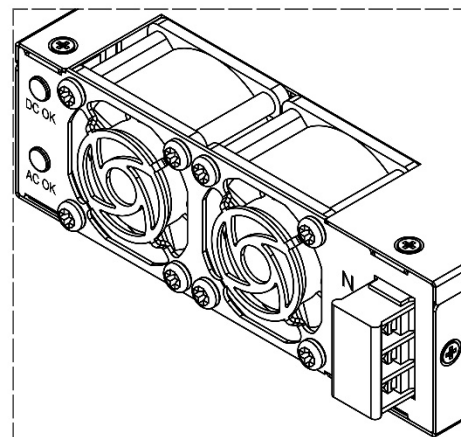

Figure 12. American Barrier Strip

CONDUCTOR SIZE: 14 - 18 AWG
TIGHTENING TORQUE: 8.0 kgf.cm

2.3.4 LED Indicator

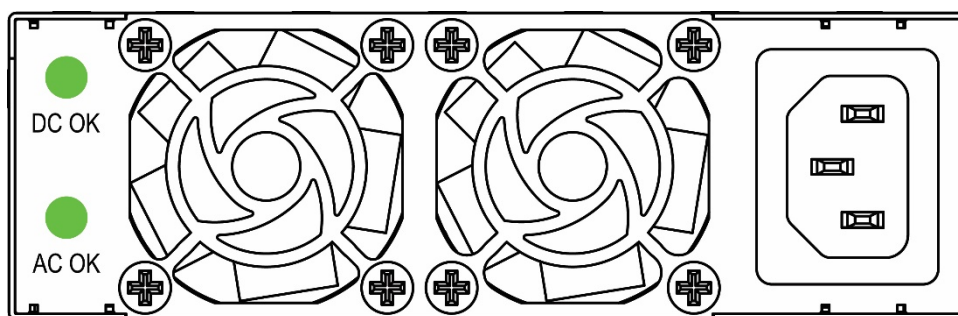

Fig. 13: LED Indicator

Two (green/off) LEDs are placed on the case fan panel with status conditions below:

DC_OK LED indicator

DC OK Led indicator will be on when all the modules are working normally, and will be off if one or more modules is shut down

AC OK LED indicator

AC OK Led indicator will be on when AC input is above the normal working voltage for the power supply and indicates the AC input status is ready for DC-DC modules to function. This indicator will be off if the AC input falls below normal working voltage for the power supply to maintain performance.

Medical / Industrial AC-DC Configurable Power Supply Up to 2100W / MEG-A series

2.3.5 Connector Definitions – Frame

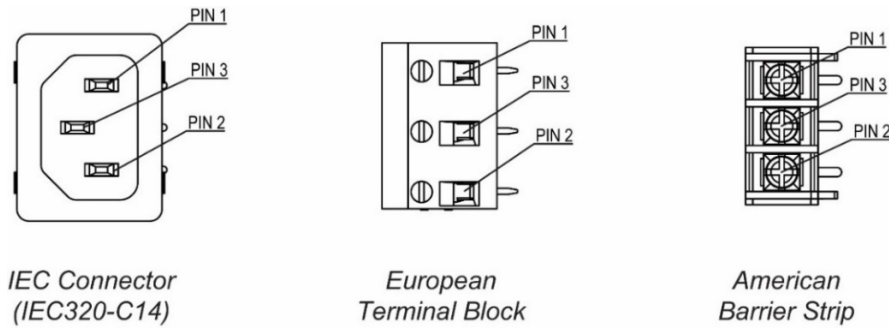

Fig. 14: AC Input Connector

Pin	Function
PIN 1	AC Line (Phase)
PIN 2	AC Neutral
PIN 3	Chassis(Earth) Ground

Table 3. AC Input Connector - Pin Assignment

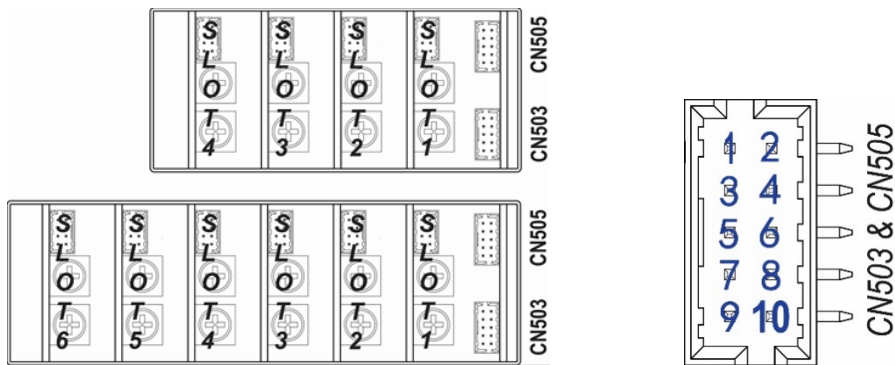

Fig. 15: Global Control Signals and Communications Connector

CN503 & CN505(Molex:87833-1031) Mating With Molex:51110-1051 or equivalent Terminal: 0503948052			
Global control signals CN503		Communication signals CN505	
Pin	Function	Pin	Function
1	AC Fail - "Collector"	1	SMBALERT'
2	AC Fail - "Emitter"	2	Address Bit 2 (A2)
3	5V_Standby +	3	Address Bit 1 (A1)
4	5V_Standby +	4	Address Bit 0 (A0)
5	5V_Standby Return	5	Reserve/No Connection
6	5V_Standby Return	6	Reserve/No Connection
7	Global Remote On_Off/Inhibit +	7	PMBus Clock (SCL)
8	Global Remote On_Off/Inhibit -	8	PMBus Data (SDA)
9	Reserve/No Connection	9	5V Communication Bus Return
10	Reserve/No Connection	10	5V Communication Bus +

Table 4. Global Control Signals and Communications Connector (CN503 & CN505) – Pin

Medical / Industrial AC-DC Configurable Power Supply

Up to 2100W / MEG-A series

2.3.6 Connector Definitions – Single Slot Single Output Module

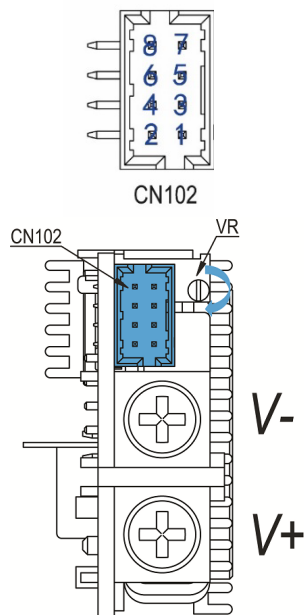

Fig. 16: -x1 Module connector

Pin	Function
V+	Output
V-	Output Return

Wire range: 8-20 AWG
Screw torque: 7.0 to 10.0 kgf.cm (6.08 to 8.68 lbf.in)
Screws are suitable for slotted and Phillips head screwdrivers.

Table 5. DC Output Port - Pin Assignment

Control Connector CN102 (Molex: 87833-0851) Mating With Molex: 51110-0851 or equivalent , Terminal: 0503948052	
Pin	Function
1	Remote On_Off/Inhibit +
2	Remote On_Off/Inhibit -
3	Remote Sense +
4	Remote Sense -
5	Power Good- "Collector"
6	Power Good- "Emitter"
7	Current Share
8	Reserve/No Connection

Table 6. Control Signals Connector - Pin Assignment

2.3.7 Connector Definitions – Triple Slot Single Output Module

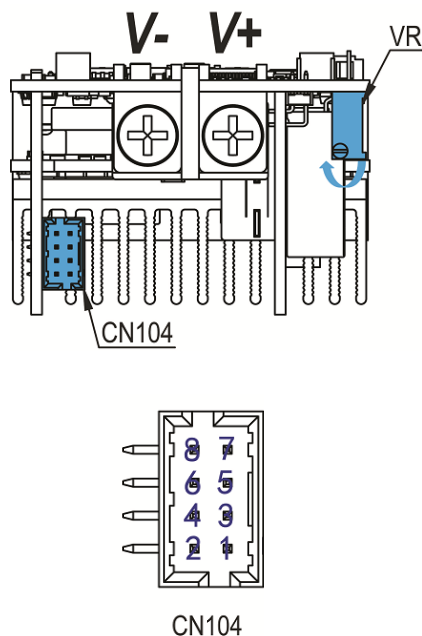

Fig. 17: -x2 Module connector

Pin	Function
V+	Output
V-	Output Return

Wire range: 2-16 AWG
Screw torque: 15.0 to 20.0 kgf.cm (13.02 to 17.36 lbf.in)
Screws are suitable for slotted and Phillips head screwdrivers.

Table 7. DC Output Port - Pin Assignment

Control Connector CN104 (Molex: 87833-0851) Mating With Molex: 51110-0851 or equivalent Terminal: 0503948052	
Pin	Function
1	Remote On_Off/Inhibit +
2	Remote On_Off/Inhibit -
3	Remote Sense +
4	Remote Sense -
5	Power Good- "Collector"
6	Power Good- "Emitter"
7	Reserve/No Connection
8	Reserve/No Connection

Table 8. Control Signals Connector - Pin Assignment

Medical / Industrial AC-DC Configurable Power Supply

Up to 2100W / MEG-A series

2.3.8 Connector Definitions – Single Slot Dual Output Module

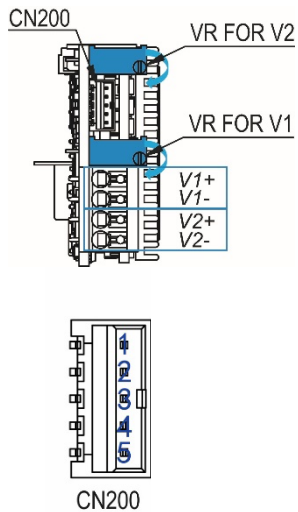

Fig. 18: -x3 Module connector

Pin	Function
V1+	V1 Output
V1-	V1 Output Return
V2+	V2 Output
V2-	V2 Output Return
Wire range: 28-16 AWG	

Table 9. DC Output Port - Pin Assignment

Control Connector CN200 (Molex: 87438-0563) Mating With Molex: 87439-0500 Terminal: 874210102	
Pin	Function
1	Remote Inhibit 2 +
2	Remote Inhibit 2 -
3	NC
4	Remote Inhibit 1 +
5	Remote Inhibit 1 -

Table 10. Control Signals Connector - Pin Assignment

Medical / Industrial AC-DC Configurable Power Supply

Up to 2100W / MEG-A series

3 Electrical Functions of Main Output

Please be noted the function description is applicable for all the modules unless specifies.

3.1 Start-up Timing

Start-up time is defined as the time duration from when the AC is applied with remote on_off signal enabled to the output voltage reaching to higher than 90% of its final steady value. MEG-A series power supply can provide 2s max start up time to meet the fast power up requirement.

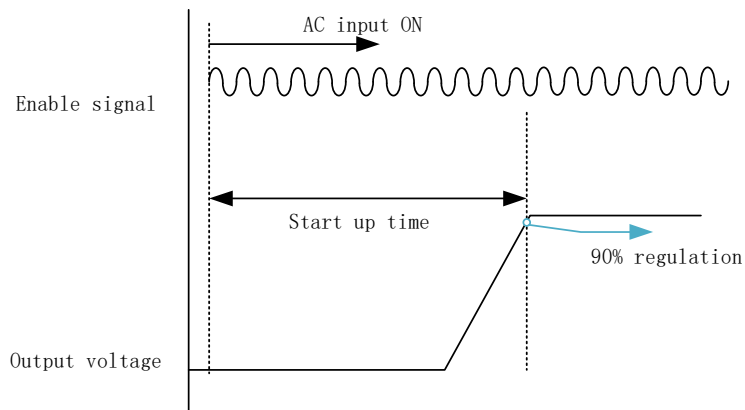

Fig. 19: Start-up timing sequence

The standard product sets the remote on_off signal to be enabled as default, if customer is choosing the reverse logic version, then remote on_off signal is required to enabled before powering up the power supply, otherwise the startup time is determined by the time when the remote on_off signal is set to be enable.

When the power supply is originally disabled and then enabled by the remote on_off control signal, the enable time is 100ms max, this includes the output rise time to 90% regulation.

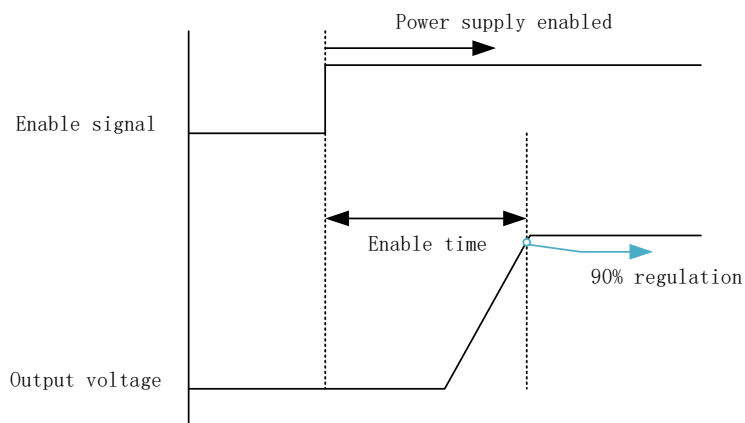

Fig. 20: Enable timing sequence

Medical / Industrial AC-DC Configurable Power Supply

Up to 2100W / MEG-A series

3.2 Rise Time

Rise time is defined as the time from when the output voltage is higher than 10% regulation voltage to the point when the output voltage reaches 90% output regulation level. The rise time provided by MEG-A series is 100ms max.

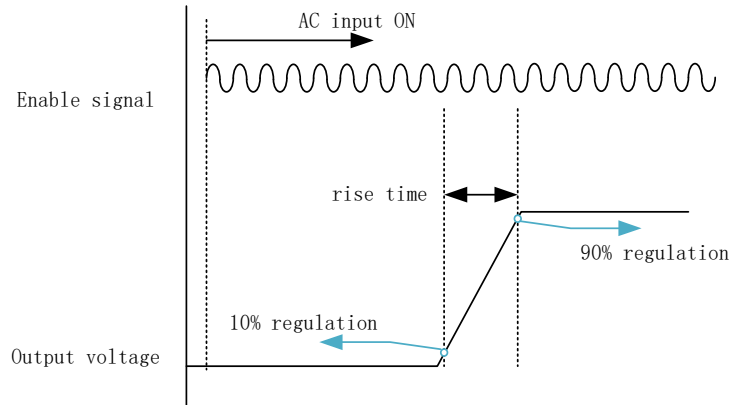

Fig. 21: Rise time sequence

3.3 Hold up Time

Hold up time provide the system the necessary back up time from when AC is collapsed to the output voltage falls below 90% regulation value. As when AC input is off, it is depending on the internal power reserved in the power supply to support the output power, different output level will bring different hold time. MEG-A series defines the hold time with rated load, as long as the input voltage is within the normal input value, the hold time can be 12ms min.

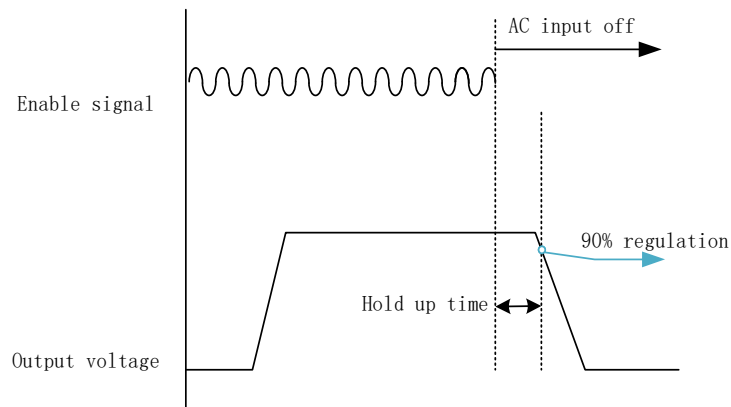

Fig. 22: Hold up time sequence

3.4 Ripple & Noise Measurement

When measuring output ripple and noise, it is recommend that use an X1 probe in parallel with a 0.47uF ceramic chip capacitor and a 10uF aluminum electrolytic capacitor, and the bandwidth should be set to 20MHz.

Below is a typical connection of the ripple & noise measurement.

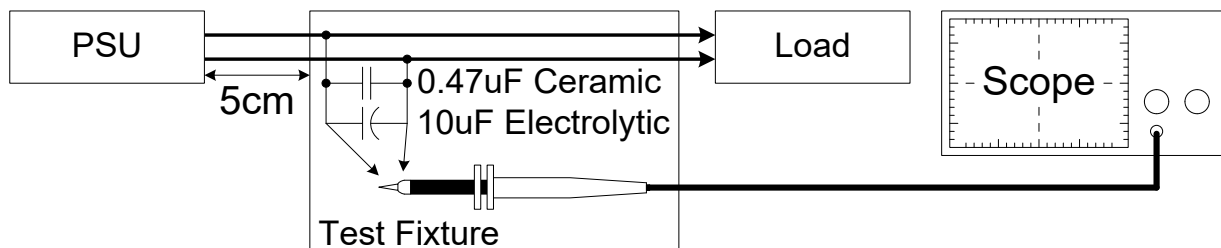

Fig. 23: Ripple and noise measurement circuit

Medical / Industrial AC-DC Configurable Power Supply

Up to 2100W / MEG-A series

3.5 Protections

3.5.1 Over Voltage Protection (OVP)

When the output voltage sees unusual high peak or the internal feedback control loop fails to lead the output voltage to be unusually high, power supply can sense the output voltage, if the output voltage is higher than certain limit (130% regulation max), the power converter will be disabled with latch mode, the way to release the latch protection is removal and re-application of the AC input voltage.

3.5.2 Over Load and Over Current Protection (OLP/OCP)

The power supply's Overload (OLP) and Over current (OCP) Protections will be activated before output current over 130% of I_o (Max load). Once the power supply has reached its maximum current limit or triggers the under voltage limit, the protection will be activated and the power supply will go into "Hiccup mode" (Auto-Recovery). The power supply will recover once the fault condition causing the OLP and OCP is removed and I_o is back within the specified limit. The time interval between each auto re-start during protection is 4s typical.

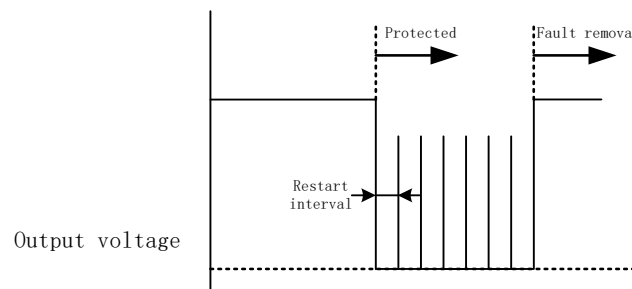

Fig. 24: Auto restart hiccup during OLP/OCP

Additionally, if the lout is $>100\%$ for a prolong period of time (depending on the load), the Over Temperature Protection (OTP) may be activated due to high temperature on critical components. The power supply will then go into latch mode.

3.5.3 Short Circuit Protection (SCP)

The protection mechanism of OLP/OCP can also provide the protection against output short circuit with same auto re-start protection mode. If the short circuit stays, output voltage will try to restart every 4 seconds and then get protected again, when the short circuit is removed and output current is within limited value, power supply will resume to normal operation.

3.5.4 Over Temperature Protection

As mentioned above, the power supply also has Over Temperature Protection (OTP). This is activated when the overload condition persists for an extended duration and the output current is below the overload trigger point but $>100\%$ load. In the event of a higher operating temperature condition at 100% load, the power supply will run into OTP when the surrounding air temperature is higher than the operating temperature. When activated, the output voltage will go into latch mode.

To re-enable the power supply output, it needs to,

- A. Turn off the AC input
- B. Remove the fault temperature ambient condition
- C. Let power supply cool down
- D. Turn on the AC again

3.5.5 Fan Fault Protection

MEG-A is embedded with fans and intelligent fan speed control, the fans are essential to achieve up to 2100W high power output without getting overheated, and the product can protect itself from detecting the fault of the fans. If the fans are not functioning properly for longer than 1minute, then the controller will consider there is potential risk for the power supply to get overheated and shut down the converter with latch mode, again to successfully restart the power supply, customer needs to remove all the fault condition that might cause the fan fault and reapply the AC input voltage to enable the output voltage again.

Medical / Industrial AC-DC Configurable Power Supply

Up to 2100W / MEG-A series

3.6 Remote On_Off Control

Remote On_Off control allows customer to easily control the power supply from system level point of view, MEG-A series uses an isolated diode located within the power supply. The remote control signal can be used to enable or disable only the main output. When the main output is disabled, the +5V Standby output will continue to operate. Every module has its own remote on/off control signal pin, and can work independently from each other.

Below is a suggested connection to use the remote on_off signal, system can use a switch to conduct through this diode to disable the main out. The signal can be floated (no connection to the signal), in order to enable the main output

It is easily to know that conduct the diode to disable the power supply and left the diode to be open to enable the output, so customer can design its own control circuit to use this signal to realize different logic control.

If customer wants a reversed control logic of the diode to enable/disable the output, please consult with Delta.

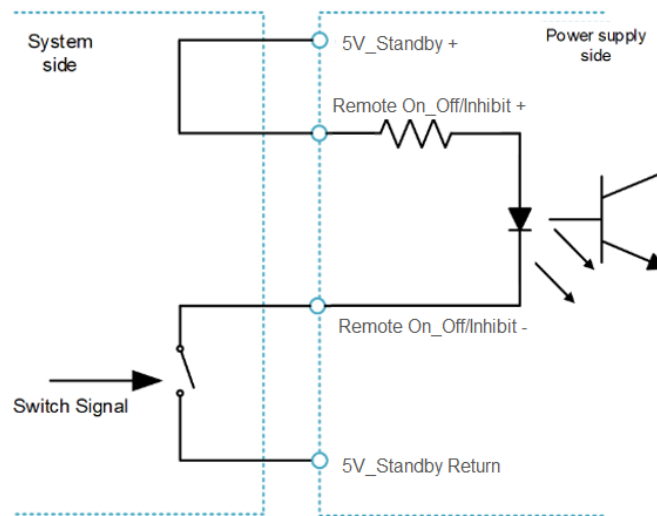

Fig. 25: Remote On_off connection

Medical / Industrial AC-DC Configurable Power Supply

Up to 2100W / MEG-A series

3.7 Power Good Signal

Power Good+/- pin on every module's control connector is an isolated open collector transistor (80V/50mA rating). A resistor (suggested value 10Kohm, 1/8W) can be added between Power Good- pin and DC RTN, Power Good+ pin can be connected to 5V standby (or, other available pull-up voltage that is no greater than the transistor rating). Value of resistor may have to be adjusted, depending on voltage used, and other end-use conditions of the Power Good+ pin connection to the product.

When AC input is on, Power Good Signal (Shown in below figure) generated will be high. When AC input is off, Power Good Signal generated will be low. There will be a minimum of 5 milliseconds between the time the Power Good Signal goes to low level, and the time when the output reaches 90% of its rated value.

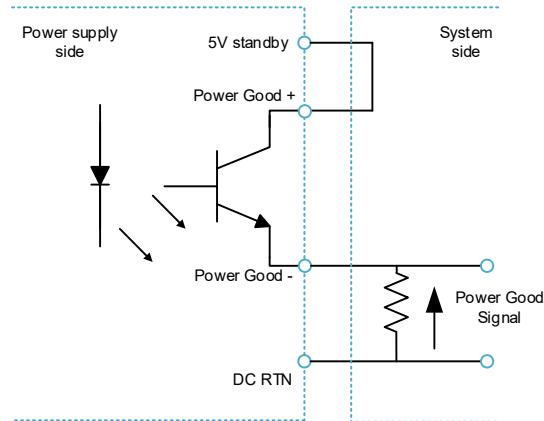

Fig. 26: Power good signal connection

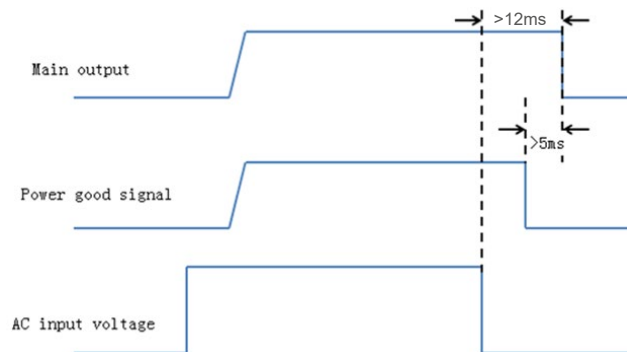

Fig. 27: Power good signal sequence

Medical / Industrial AC-DC Configurable Power Supply

Up to 2100W / MEG-A series

3.8 Voltage Adjustment

The power supply provides a potentiometer for user to adjust the output voltage. The output voltage is designed to be able to adjust up to $\pm 10\%$ of rated voltage, when the output is adjusted below nominal value, the maximum output current is the same as the nominal output, when the output is adjusted above nominal value, the output power cannot exceed the nominal maximum power (the maximum output current will be reduced accordingly).

3.9 Remote Sense Connection

Remote sense feature can be used to compensate for the extra voltage drop on output wires that are connected from the main output terminals, to the load. With wires connected from the remote sense pins, at the same locations as the wires from the main output.

Note that line drop (voltage drop due to wiring) compensation voltage range must be such that the output voltage is

within the output voltage adjustment range and that the voltage to compensate must be within 0.5V (in the connection picture, $V_o - V_{o_load}$ must be less than 0.5V, or $DC_RTN_load - DC_RTN$ be less than 0.5V).

Consider power loss due to line drop and use this unit within the maximum allowable output power. Reduce the effect of noise induced into the remote sensing lines by using shielded lines, a twist pair, or a parallel pattern, etc.

MEG-A series also provides the protection mode if the remote sense wire connection is fault made, the power supply will not be damaged if the remote sense pins are shorted, or if a reverse/inverted polarity connection is made to the load, this gives more reliable operation in real application. To be noted, if misconnect the remote sense wires, the power supply will be protected and can not normally operate, please check the wire connection carefully before power up the product in this case.

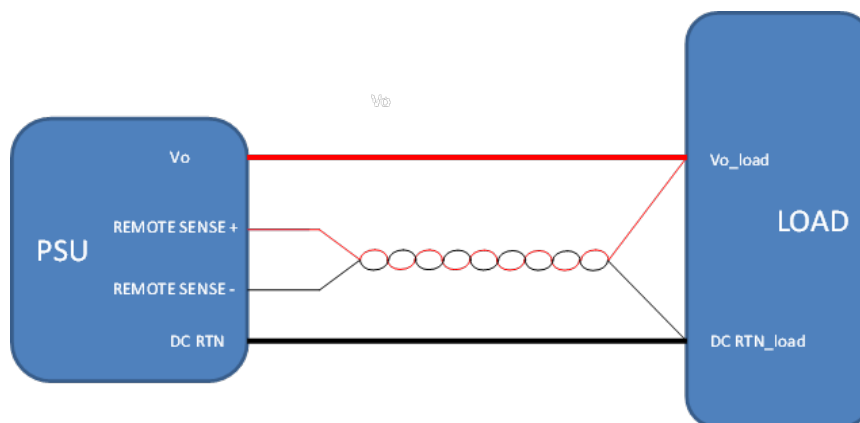

Fig. 28: Remote sense connection

Medical / Industrial AC-DC Configurable Power Supply

Up to 2100W / MEG-A series

3.10 Remote Sense Connection Under Parallel Operation

The single slot single output series has an active current sharing circuit for the main output; it can realize the output current to be balanced when customer is using only two modules in parallel to achieve higher output power. Please contact Delta for assistance if more than two modules are paralleled together for higher output power.

A one wire current share bus is used to achieve current sharing between units, the current share bus must be connected together among different units (pin 7 of CN102, refer to power supply structure and pin assignment in section 2.3).

The paralleled units can be connected with or without remote sense function, below is a typical connection of the parallel connection.

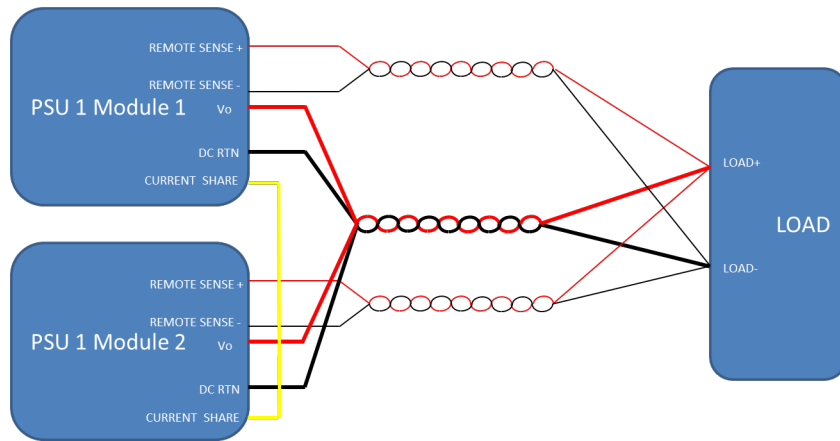

Fig. 29: Parallel connection with remote sense

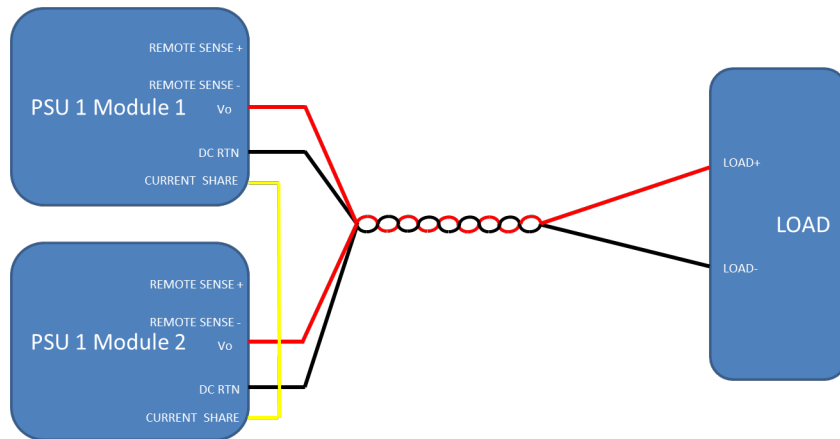

Fig. 30: Parallel connection without remote sense

Normally Delta will ship the assembled configurable power supply with parallel code from customer, and connect the current share pin. Option can be left for customer to make current share and parallel working too of two same modules are working together. An external Or-ing circuit is also needed to form a redundant connection.

Medical / Industrial AC-DC Configurable Power Supply

Up to 2100W / MEG-A series

3.11 Series Operation

It is possible to connect two or more modules in series to increase output voltage. The module's output voltage can be the same or different. However, it is highly recommend that the series modules have the same voltage and current rating, so that it can be shut down synchronously in OCP and SCP conditions.

There will need to have an external schottky diode in parallel with each output to prevent reversed voltage, and this diode need to select and verify by customer. The recommend rating for this diode is twice of the selected modules' maximal output.

When series total output voltage exceeds 60V SELV, all safety concerned items must be verified at final equipment side.

Below is a typical connection of two modules in series together.

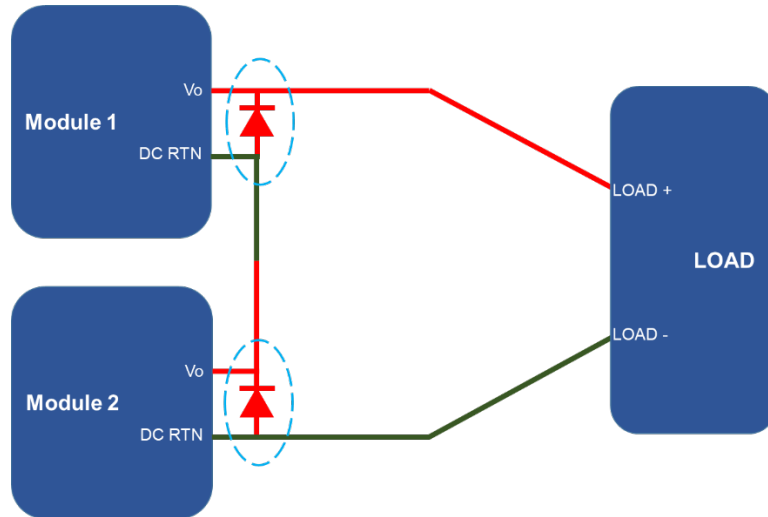

Fig. 31: Series connection with external reversed diode

3.12 Global Remote On_off/Inhibit

Global Remote On_off control on the control board allows customer to control all the modules at the same time, MEG-A series uses an isolated diode located within the power supply. The remote control signal can be used to enable or disable all the main output.

Below is a suggested connection to use the global remote on_off signal, system can use a switch to conduct through this diode (suggested pull up resistor to 5V standby with 510ohm resistor) to disable the main out. The signal can be floated (no connection to the signal), in order to enable the main output

It is easily to know that conduct the diode to disable the power supply and left the diode to be open to enable the output, so customer can design its own control circuit to use this signal to realize different logic control.

If customer wants a reversed control logic of the diode to enable/disable the output, please consult with Delta.

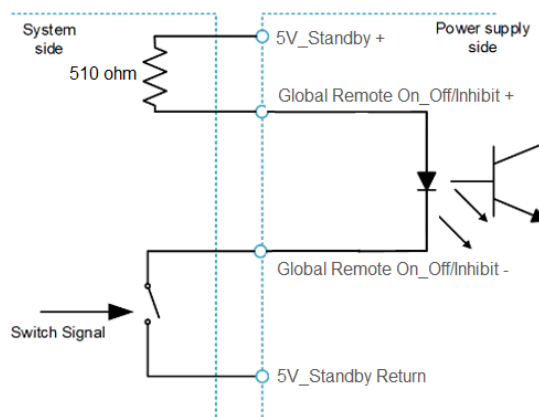

Fig. 32: Global Remote On_off connection

Medical / Industrial AC-DC Configurable Power Supply

Up to 2100W / MEG-A series

3.13 AC Fail

AC Fail signal allow the alert provide to system side the absence of the AC input. AC Failed pin is an open collector type output (80V/50mA rating). AC fail signal connection can refer to power good signal. When AC input is on, AC Fail pin will be high. When AC input is removed, AC Fail pin will be pulled low.

4 PMbus

Please refer to "I2C Communication Specification for Standard Series Products" in Appendix A.

I2C communication pins PMBUS_CLK and PMBUS_DATA are internal pull-up by 5.1Kohm resistor to 5.0V standby. The internal and external total pull-up resistor shall be between 4.7Kohm and 100Kohm, customer shall verify the external pull-up resistor in system side.

The MEP-PMB series interface adapter is designed for converting I2C communication protocol used in Delta standard industry and medical power supply unit to other interface, including USB, RS485, RS232. An on board address switch can configure up to 8 address in one bus. Below is the three adaptors and the assembly with PSU.

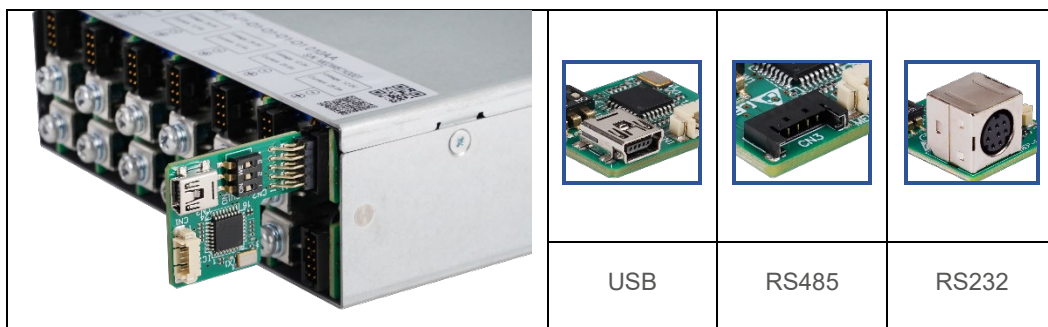

5 Power Derating

Power Derating – MEG-2K1A Series and MEG-1K2A Series

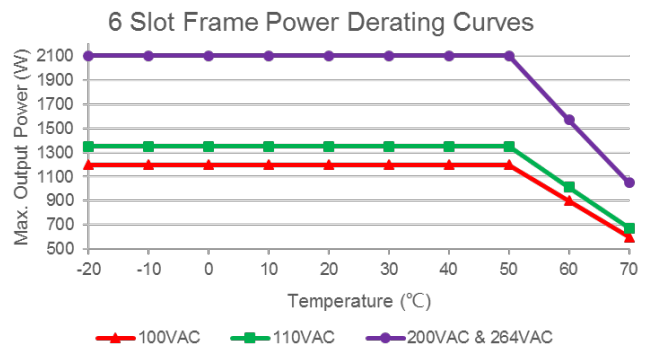
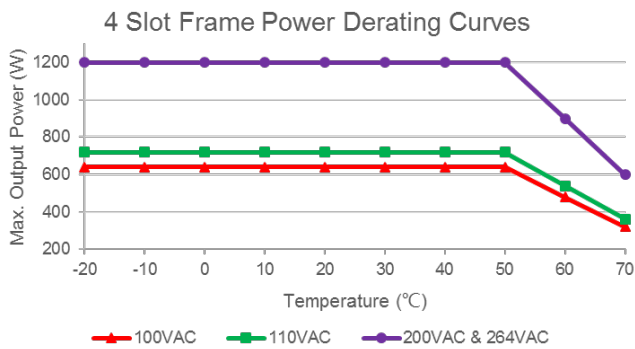

Medical / Industrial AC-DC Configurable Power Supply

Up to 2100W / MEG-A series

Power Derating – Triple Slot Modules

No air flow direction power derating unless specifically identified.

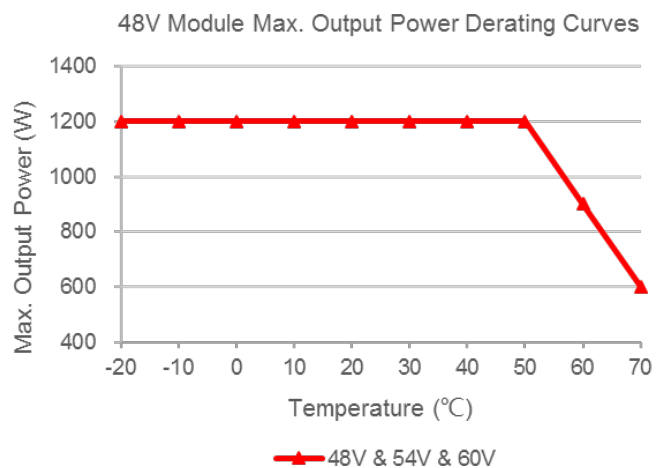
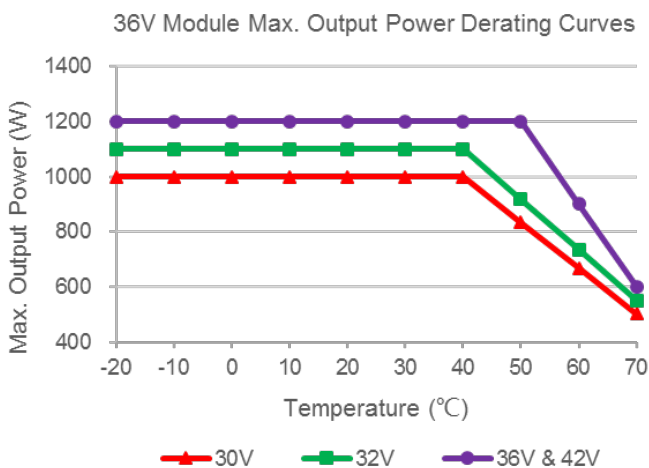
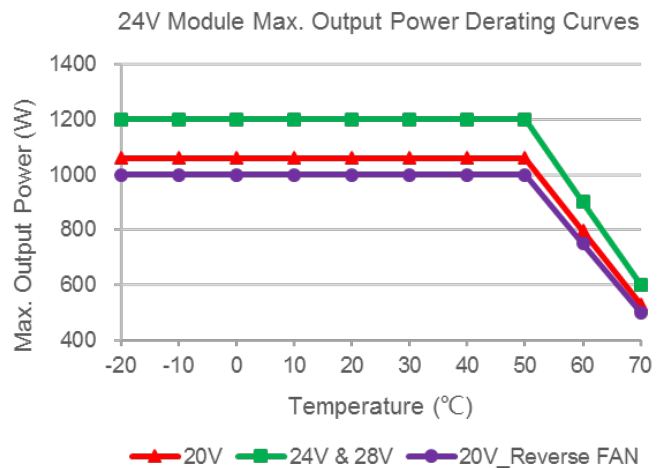
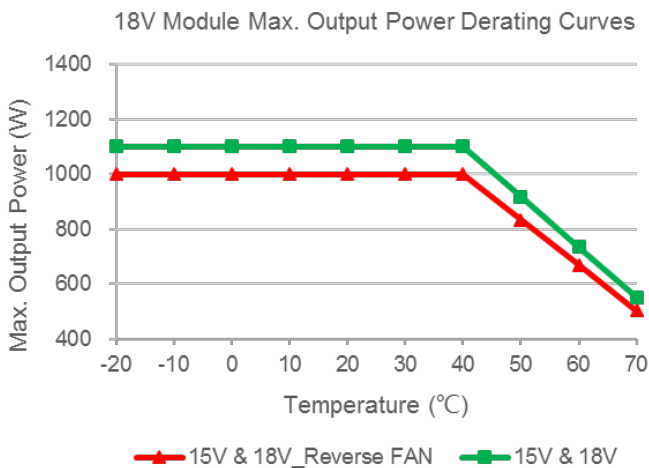
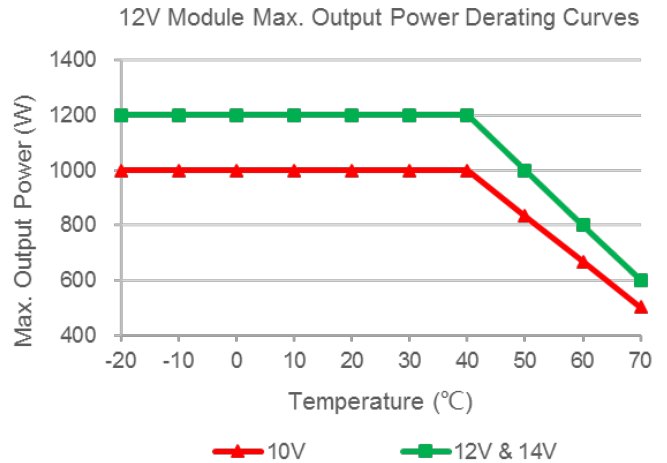
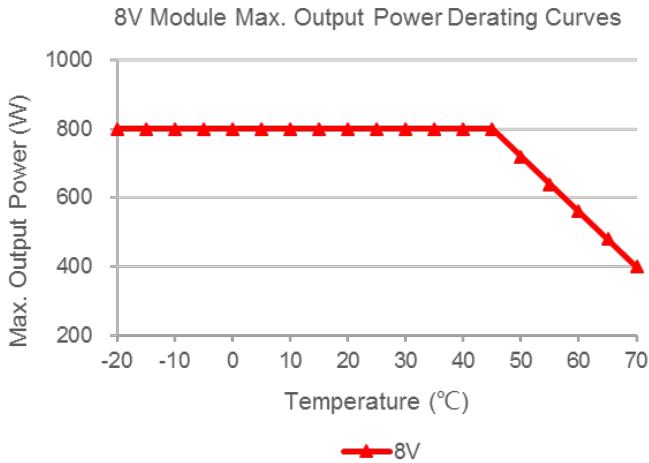

Medical / Industrial AC-DC Configurable Power Supply

Up to 2100W / MEG-A series

Power Derating – Single Slot Modules & Dual Output Modules

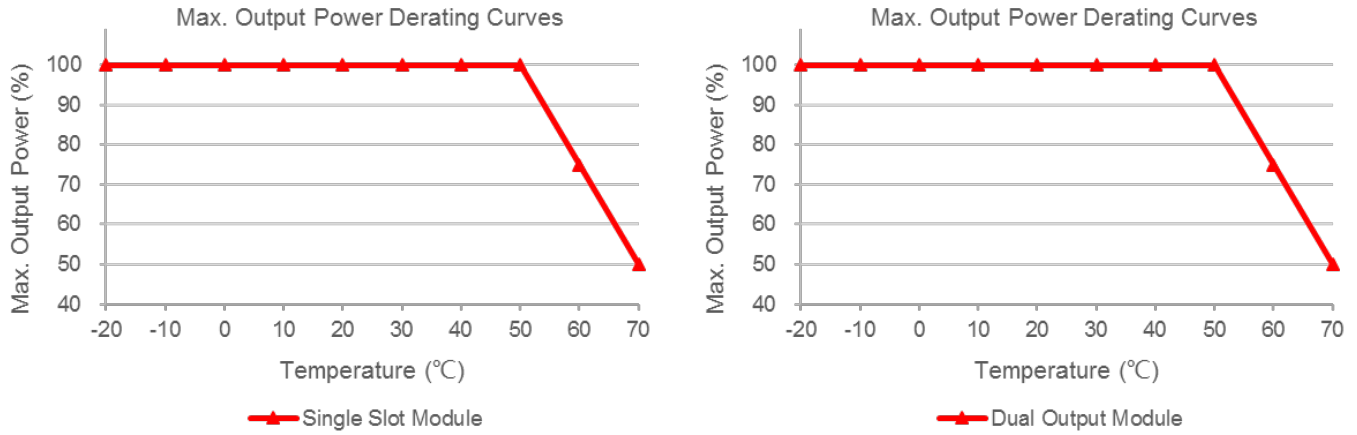

6 EMC Performance Guidelines

All configurable modules are designed to comply with EN55032/CISPR32/FCC47 part 15 Class B limits. However, the EMC performance is critically dependent on customer system. So it is recommended that the performance should be finally evaluated with customer environment. A high flux and low magnetic permeability ($\mu=125$) common inductor may be needed in the power supply input to guarantee system compliance. The recommend inductance is about 7uH.

Medical / Industrial AC-DC Configurable Power Supply

Up to 2100W / MEG-A series

Appendix A: I²C Communication Specification for Standard Series Products

Table of Contents

Appendix A: I ² C Communication Specification for Standard Series Products	33
1 Overview	36
1.1 Introduction	36
1.2 Referenced Standards	36
1.3 Acronyms and Definitions	36
2 Protocol Descriptions	36
2.1 Communication Topology	36
2.2 Communication Signal	36
2.3 Address Selection	37
2.4 Command Structure	37
3 Command List	40
4 Reporting Command	42
4.1 Report Vout Mode	42
4.2 Report Vout Command	42
4.3 Report Vout Max	43
4.4 Report Vout Min	43
4.5 Report Coefficients	44
4.6 Report Fan Configuration	45
4.7 Report Fan Command 1/2	45
4.8 Report OVP Fault Limit	46
4.9 Report OVP Fault Response	46
4.10 Report UVP Fault Limit	47
4.11 Report UVP Fault Response	47
4.12 Report OTP Fault Limit	48
4.13 Report OTP Fault Response	48
4.14 Report Status Byte	49
4.15 Report Status Word	49
4.16 Report Vout Status	50
4.17 Report Iout Status	51
4.18 Report Temperature Status	52
4.19 Report CML Status	52
4.20 Report Manufacturer Specific Status	53
4.21 Report Fan Status	54
4.22 Report Output Voltage	54
4.23 Report Output Current	55
4.24 Report Temperature	55
4.25 Report Fan Speed 1/2	56
4.26 Report Output Power	56
4.27 Report PMBus Revision	57
4.28 Report Manufacturer ID	57

Medical / Industrial AC-DC Configurable Power Supply

Up to 2100W / MEG-A series

4.29	Report Manufacturer Model Name.....	58
4.30	Report Manufacturer Version.....	58
4.31	Report Manufacturer Serial Number.....	59
4.32	Report Max Rated Voltage.....	59
4.33	Report Max Rated Current.....	60
4.34	Report Max Rated Power.....	60
4.35	Report Max Rated Ambient Temperature.....	61
4.36	Report CC/CV Mode.....	61
4.37	Report Page.....	62
4.38	Report Operation.....	62
4.39	Report On Off Configure.....	63
4.40	Page Plus Read.....	64
4.41	Report Write Protect.....	64
4.42	Capability.....	65
4.43	QUERY.....	66
4.44	SMBALERT Mask.....	67
4.45	Report Vin On.....	67
4.46	Report Vin Off.....	68
4.47	Report Vout UV Warn Limit.....	68
4.48	Report Iout OC Fault Limit.....	69
4.49	Report IOUT OC Fault Response.....	69
4.50	Report UTP Fault Limit.....	70
4.51	Report UTP Fault Response.....	70
4.52	Report Input Voltage.....	71
4.53	Report Output Power.....	71
4.54	Report Frame Firmware Version.....	72
4.55	Report Module Firmware Version.....	72
4.56	Report Module Serial Number.....	73
4.57	Report Module Model Name.....	73
4.58	Report Module Output Number.....	74
4.59	Report Parallel Information.....	74
4.60	Report Max Output Current.....	75
4.61	Report Min Output Current.....	75
4.62	Report Remote Control Status.....	76
4.63	Report Slot Status.....	76
4.64	Get Module Status.....	77
5	Setting Command.....	78
5.1	Clear Faults.....	78
5.2	Set Vout Command.....	79
5.3	Set Page.....	79
5.4	Operation.....	80
5.5	Page Plus Write.....	81
5.6	Write Protect.....	81
5.7	Store Default All.....	82

Medical / Industrial AC-DC Configurable Power Supply

Up to 2100W / MEG-A series

5.8	Restore Default All.....	82
5.9	Store Default Code	83
5.10	Restore Default Code	83
5.11	Store User All.....	84
5.12	Restore User All.....	84
5.13	Store User Code	85
5.14	Restore User Code	85
5.15	Remote Control.....	86
5.16	Set Fan Command 1/2.....	86
6	PEC Calculation	87

Medical / Industrial AC-DC Configurable Power Supply

Up to 2100W / MEG-A series

1 Overview

1.1 Introduction

The specification provides a means for all PSUs can use for internal or external communication. And this document describes communication protocols and its utilized methods. All commands mentioned in this document follow the PMBus™ protocol standard.

1.2 Referenced Standards

- SMBus Specification Version3.0
- PMBus Specification Part I Revision1.3.1
- PMBus Specification Part II Revision1.3.1

1.3 Acronyms and Definitions

CMD: command

PSU: power supply unit

I2C: inter-integrated circuit

OPP: over power protection

OVP: over voltage protection

UVP: under voltage protection

OTP: over temperature protection

CML: communication, memory or logic

ACK: Acknowledge. The response from a receiving unit indicates that it has received the byte.

NACK: Not Acknowledge. The response from a receiving unit indicates that it has received invalid data.

2 Protocol Descriptions

2.1 Communication Topology

The typical topology is master-slave mode via I2C interface, which host device is defined as master and PSU device is slave. Normally, communication is initiated by master. And the structure is shown as below.

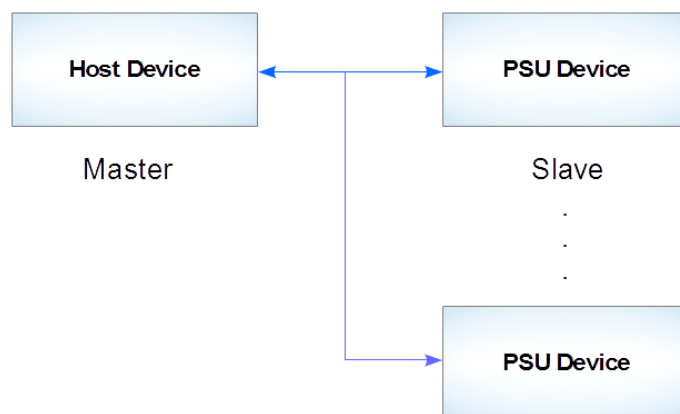

Fig. 1: I2C topology

2.2 Communication Signal

The communication speed is 100 kbps, and voltage is 5V.

Medical / Industrial AC-DC Configurable Power Supply

Up to 2100W / MEG-A series

2.3 Address Selection

To communicate with host, each PSU shall have a default address. This address can be different due to projects. As shown in figure2-1, there might be several PSUs at the same time. Therefore, to avoid confliction, each PSU shall have a unique address. And this is realized through address pin A2 to A0. By the combination of address pins, there is up to 8 selections. Address list is shown in the table below:

Table 1. Address List

A2 ¹	A1	A0	MEG-A Series ²
0	0	0	0x50(default)
0	0	1	0x51
0	1	0	0x52
0	1	1	0x53
1	0	0	0x54
1	0	1	0x55
1	1	0	0x56
1	1	1	0x57

Note:

1. A voltage of 5V reflects the symbol '1' in the list, and 0V reflects the symbol '0'.
2. A2 to A0 is located on connector CN603 pin2 to pin4.

2.4 Command Structure

2.4.1 Bit and Byte Illustration

The transmission of bits and bytes is illustrated in this section. In all cases, a byte contains 8 bits and is transferred from MSB to LSB. The LSB is always bit 0, and MSB is always bit 7, as shown in below:

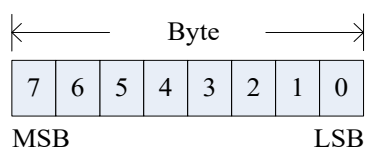

Fig. 2: Byte illustration

Medical / Industrial AC-DC Configurable Power Supply

Up to 2100W / MEG-A series

2.4.2 Setting Command

The table below is the typical format of a setting command, the un-shaded bit indicates the data sent from master to slave, and the shaded bit is returned from slave to master.

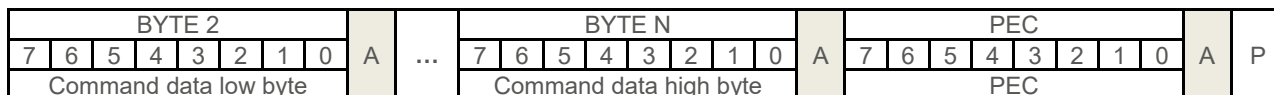
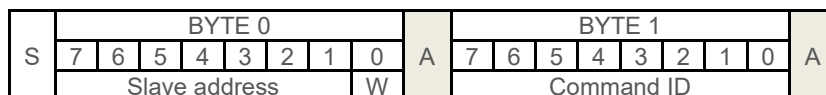

The symbols used to describe this command are shown as below:

Table 2. Command Description

Symbol	Description
S	A start condition sent by a host device
Slave address ¹	First seven bits of the physical address to identify device
W	A value of 0 indicating the device is addressed with a writing command
A	ACK condition sent by a PSU device
Command ID	A byte followed the address byte indicating command type
Command data high byte	Last byte of command data, data length depends on each command
Command data low byte	First byte of command data
PEC	CRC byte of this command, calculated from address byte to the last byte of command data, detail information is referred to Chapter 6
P	A stop condition sent by a host device

Note:

- For example, if physical address is 0x28, then slave address is 0b0101000.

Medical / Industrial AC-DC Configurable Power Supply

Up to 2100W / MEG-A series

2.4.3 Reporting Command

The table below is the typical format of a reporting command, the un-shaded bit indicates the data sent from master to slave, and the shaded bit is from slave to master. If the command ID is not supported by slave, the read data byte should be filled by 0xFF.

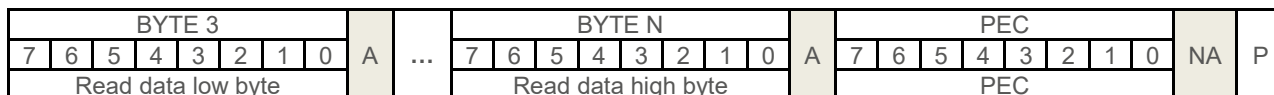
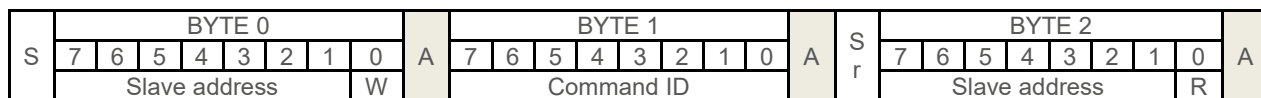

The symbols used to describe this command are shown as below:

Table 3. Command Description

Symbol	Description
Sr	A repeated start condition sent by a host device
R	A value of 1 indicating the device is addressed with a reading command
Read data high byte	Last byte of read data, data length depends on each command
Read data low byte	First byte of read data
NA	NACK condition sent by a host device

Medical / Industrial AC-DC Configurable Power Supply

Up to 2100W / MEG-A series

3 Command List

The following sets of commands follow the standard PMBus™ protocol specification. And each product will support different commands.

Table 4. Standard PMBus Commands

ID	Name	Data Format	Data Length ¹	MEG-A Series
00h	Page	Direct ²	1	Write/Read
01h	Operation	N/A ³	1	Write/Read
02h	On Off Configure	N/A	1	Read
03h	Clear Fault	N/A	0	Write
04h	Phase	Direct	1	Write/Read
05h	Page Plus Write	N/A	Variable	Write
06h	Page Plus Read	Process Call ⁴	Variable	Read
10h	Write Protect	N/A	1	Write/Read
11h	Store Default All	N/A	0	Write
12h	Restore Default All	N/A	0	Write
13h	Store Default Code	N/A	1	Write
14h	Restore Default Code	N/A	1	Write
15h	Store User All	N/A	0	Write
16h	Restore User All	N/A	0	Write
17h	Store User Code	N/A	1	Write
18h	Restore User Code	N/A	1	Write
19h	Capability	N/A	1	Read
1Ah	Query	Process Call	1	Read
1Bh	Smbalert Mask	Process Call	2	Read
20h	Vout Mode	N/A	1	Read
21h	Vout Command	Direct	2	Write/Read
24h	Vout Max	Direct	2	Read
2Bh	Vout Min	Direct	2	Read
30h	Coefficients	Process Call	5	Read
35h	Vin On	Direct	2	Read
36h	Vin Off	Direct	2	Read
3Ah	Fan Configure1/2	N/A	1	Read
3Bh	Fan Command1	Direct	2	Write/Read
3Bh	Fan Command2	Direct	2	Write/Read
40h	Vout OV Fault Limit	Direct	2	Read
41h	Vout OV Response	N/A	1	Read
43h	Vout UV Warn Limit	Direct	2	Read
44h	Vout UV Fault Limit	Direct	2	Read
45h	Vout UV Response	N/A	1	Read
46h	Iout OC Fault Limit	Direct	2	Read
47h	Iout OC Fault Response	Direct	2	Read
4Fh	OT Fault Limit	Direct	2	Read
50h	OT Fault Response	N/A	1	Read
53h	UT Fault Limit	Direct	2	Read
54h	UT Fault Response	N/A	1	Read
78h	Status Byte	N/A	1	Read
79h	Status Word	N/A	2	Read
7Ah	Status Vout	N/A	1	Read

Medical / Industrial AC-DC Configurable Power Supply

Up to 2100W / MEG-A series

7Bh	Status Iout	N/A	1	Read
7Dh	Status Temperature	N/A	1	Read
7Eh	Status CML	N/A	1	Read
80h	Status MFR Specific	N/A	1	Read
81h	Status Fans1/2	N/A	1	Read
88h	Read Vin	Direct	2	Read
8Bh	Read Vout	Direct	2	Read
8Ch	Read Iout	Direct	2	Read
8Dh	Read Temperature1	Direct	2	Read
90h	Read Fan Speed1	Direct	2	Read
90h	Read Fan Speed2	Direct	2	Read
96h	Read Pout	Direct	2	Read
98h	PMBus Revision	N/A	1	Read
99h	MFR ID	N/A	15	Read
9Ah	MFR Model	N/A	34	Read
9Bh	MFR Revision	N/A	15	Read
9Eh	MFR Serial	N/A	15	Read
A5h	MFR Vout Max	Direct	2	Read
A6h	MFR Iout Max	Direct	2	Read
A7h	MFR Pout Max	Direct	2	Read
A8h	MFR Ambient Temp Max	Direct	2	Read

Note:

1. The unit of data length is byte.
2. N/A means no numeric data in this command.
3. Direct means this command contains numeric data, normally low byte data is sent first and then comes the high byte data. Detail information can be obtained via coefficient command (30h).
2. Detail information is referred to command.

The following sets of commands also belong to PMBus™ protocol specification, but defined as manufacturer specific commands. And each product will support different commands.

Table 5. Manufacturer Specific Commands

ID	Name	Data Format	Data Length	MEG-A Series
C5h	Module FW Version	N/A	15	Read
C6h	Module Serial	N/A	15	Read
C8h	Module Name	N/A	15	Read
C9h	Module Output Number	Direct	1	Read
CAh	Parallel Information	N/A	1	Read
CCh	Iout Max	Direct	2	Write/Read
CDh	Iout Min	Direct	2	Read
CEh	Remote Control	N/A	1	Write/Read
CFh	CC/CV Mode	N/A	1	Read
D4h	Read Slot Status	N/A	2	Read
DCh	Get Module Status	N/A	15	Read

Medical / Industrial AC-DC Configurable Power Supply

Up to 2100W / MEG-A series

4 Reporting Command

4.1 Report Vout Mode

This command is for master device to retrieve data form of voltage related commands.

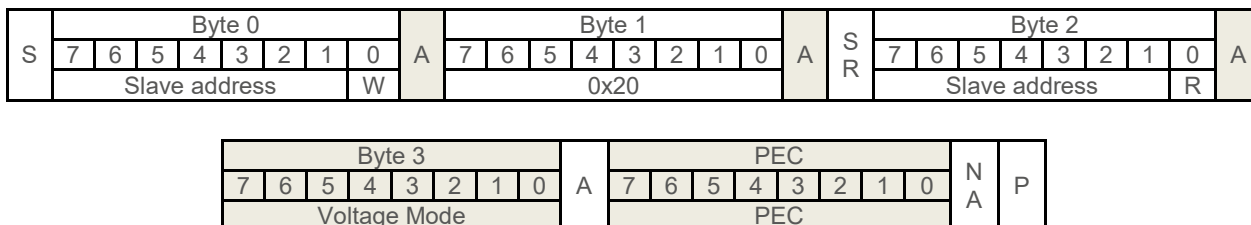

Range:

Voltage Mode Definition:

Bit	Meaning
7	0 -- Absolute / 1 -- Relative
6~5	00 -- Ulinear 16 / 01 -- VID / 10 -- Direct / 11 -- IEEE Half
4~0	TBD

Example:

Command	Description
10 20 11 40 A1	Voltage command is in direct data mode

Note:

1. Slave address is assumed to be 0b0001000 in the example.
2. The value returned is the information of all modules.

4.2 Report Vout Command

This command is for master device to retrieve PSU's voltage reference.

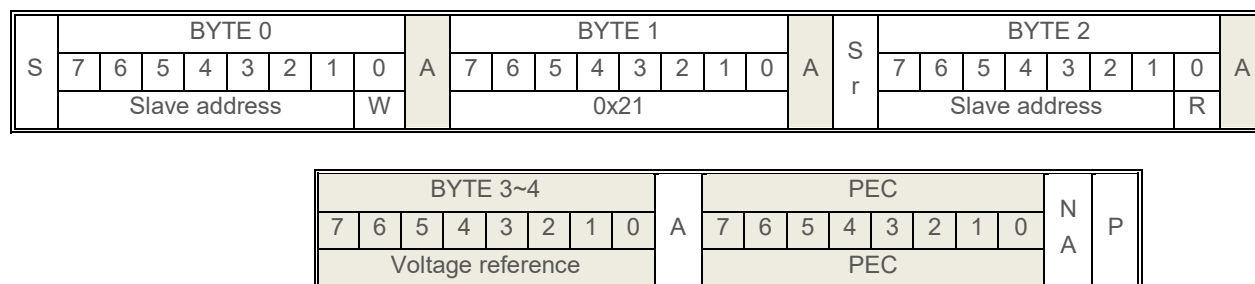

Example:

COMMAND	DESCRIPTION
10 21 11 08 01 8C	Voltage reference is 26.4V

Note:

1. Slave address is assumed to be 0b0001000 in the example.
2. Report data has two bytes and accuracy is one decimal place, the unit is Volt. Low byte is sent first, and then comes after the high byte.
3. The value returned is the information of selected page, and for multi-output modules, the value is from selected phase, and for multi-output modules, the value is from selected phase.

Medical / Industrial AC-DC Configurable Power Supply

Up to 2100W / MEG-A series

4.3 Report Vout Max

This command is for master device to retrieve PSU's max value of voltage reference.

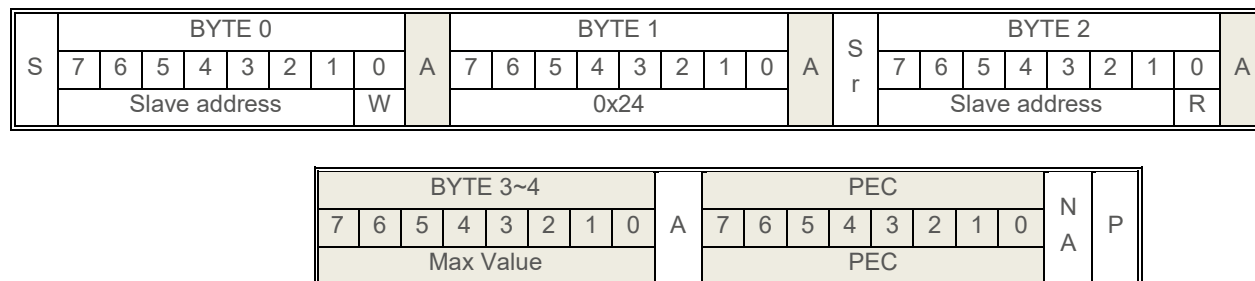

Example:

COMMAND	DESCRIPTION
10 24 11 08 01 C2	Max value of voltage reference is 26.4V

Note:

1. Slave address is assumed to be 0b0001000 in the example.
2. Report data has two bytes and accuracy is one decimal place, the unit is Volt. Low byte is sent first, and then comes after the high byte.
3. The value returned is the information of selected page, and for multi-output modules, the value is from selected phase.

4.4 Report Vout Min

This command is for master device to retrieve PSU's min value of voltage reference.

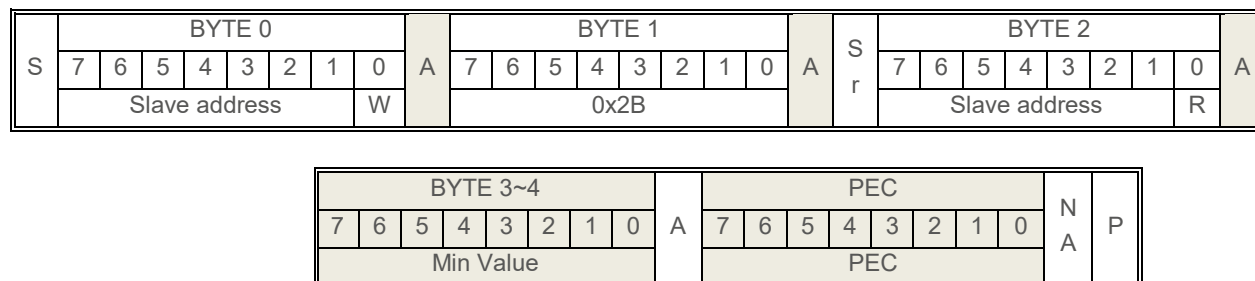

Example:

COMMAND	DESCRIPTION
10 2B 11 D8 00 92	Min value of voltage reference is 21.6V

Note:

1. Slave address is assumed to be 0b0001000 in the example.
2. Report data has two bytes and accuracy is one decimal place, the unit is Volt. Low byte is sent first, and then comes after the high byte.
3. The value returned is the information of selected page, and for multi-output modules, the value is from selected phase

Medical / Industrial AC-DC Configurable Power Supply

Up to 2100W / MEG-A series

4.5 Report Coefficients

This command is for master device to retrieve PSU's m, b and R coefficients needed by data in direct format.

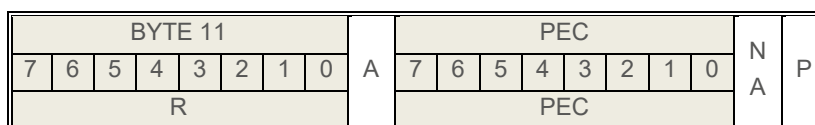
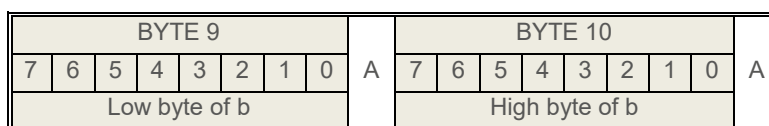
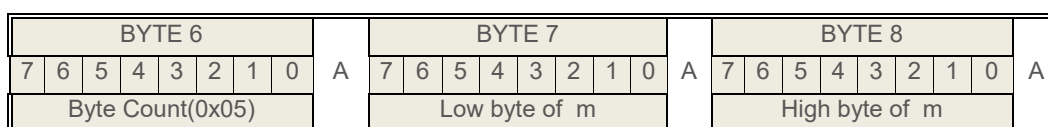
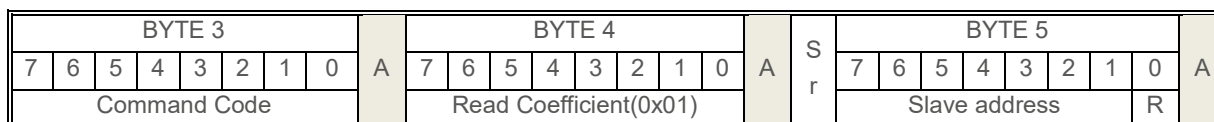
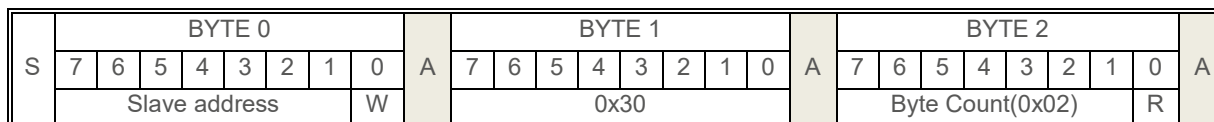

Example:

COMMAND	DESCRIPTION
10 30 02 21 01 11 05 01 00 00 00 01 5D	The coefficients of Vout command are m is 1, b is 0 and R is 1.

Note:

- Slave address is assumed to be 0b0001000 in the example.
- The value returned is the information of all pages.
- By selecting command ID in command code byte, this command provides a method for master to retrieve coefficient information of each command in direct data format.

A host device must use the following equation to convert the reporting data from PSU into the actual value in "real word".

$$\text{Actual Value} = \frac{1}{m}(\text{Report data} \times 10^{-R} - b)$$

Where:

m is the slope with two bytes, b is the offset with two bytes and R is exponent with one byte. And all m, b and R is two's complement integer.

And to send a value, a host device must use the following equation to transfer data for PSU.

$$\text{Sending data} = (m \times \text{Actual value} + b) \times 10^R$$

Where m, b and R is same above.

Take Vout command as example, the coefficients of Vout command are m is 1, b is 0 and R is 1. Therefore, if reporting data is 264(0x01 0x08), it means the actual voltage reference is 26.4V. And also if host wants to set PSU voltage reference to 26.4V, sending data shall be 264. However, if selecting a command ID in N/A format, then all coefficients data returned is 0x00.

- If the command ID is not supported, the return value would be 0. If the data format of the command ID is not direct, the return value would be the same with the VOUT value.

Medical / Industrial AC-DC Configurable Power Supply

Up to 2100W / MEG-A series

4.6 Report Fan Configuration

This command is for master device to retrieve fan configuration information in PSU.

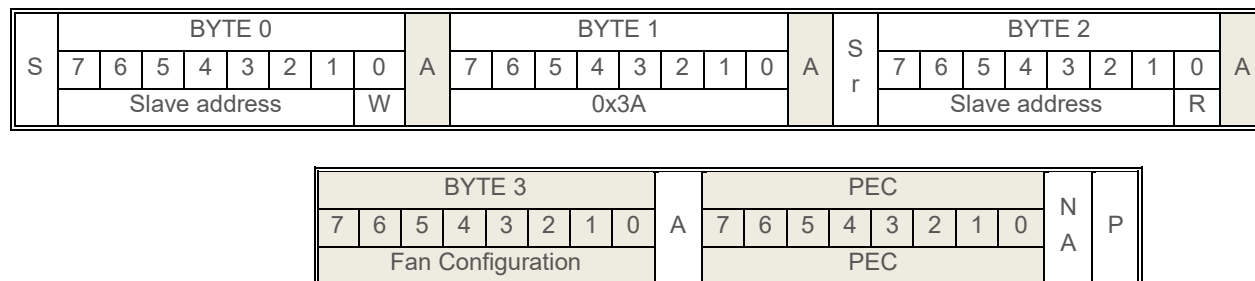

Range:

Fan Configuration Definition:

BIT	MEANING
7	0 -- Fan1 not install / 1 -- Fan1 installed
6	0 -- Fan1 in duty cycle mode / 1 -- Fan1 in R.P.M mode
5~4	00 -- 1 pulse / 01 -- 2 pulses / 10 -- 3 pulses / 11 -- 4 pulses per revolution
3	0 -- Fan2 not install / 1 -- Fan2 installed
2	0 -- Fan2 in duty cycle mode / 1 -- Fan2 in R.P.M mode
1~0	00 -- 1 pulse / 01 -- 2 pulses / 10 -- 3 pulses / 11 -- 4 pulses per revolution

Example:

COMMAND	DESCRIPTION
10 3A 11 99 85	Fan1 and fan2 is installed in duty with 2 pulses per revolution

Note:

1. Slave address is assumed to be 0b0001000 in the example.
2. The value returned is the information of all pages.

4.7 Report Fan Command 1/2

This command is for master device to retrieve PSU's current fan duty value.

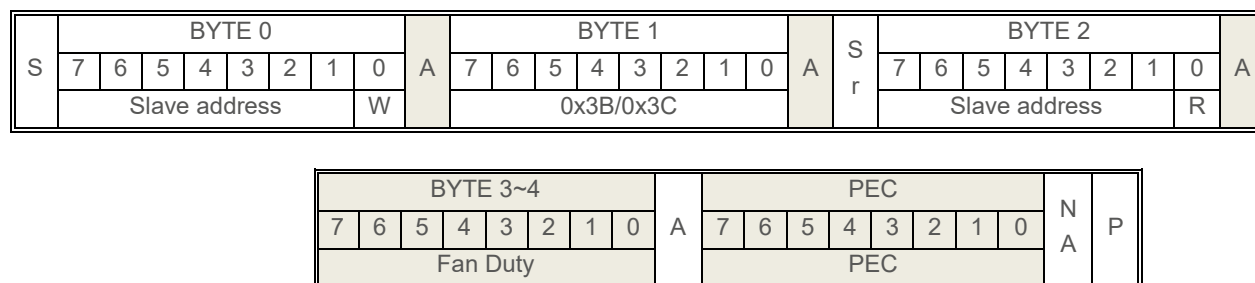

Example:

COMMAND	DESCRIPTION
10 3B 11 2C 01 8D	Fan 1 current duty is 30.0%

Note:

1. Slave address is assumed to be 0b0001000 in the example.
2. Report data has two bytes and accuracy is one decimal place, the unit is %. Low byte is sent first, and then comes after the high byte.
3. The value returned is the information of the whole PSU.

Medical / Industrial AC-DC Configurable Power Supply

Up to 2100W / MEG-A series

- If the user not set the fan command at this power on time, the value returned would be 0.
- If the set value of fan command is smaller than the temperature loop of PSU, the return value would be the temperature loop.

4.8 Report OVP Fault Limit

This command is for master device to retrieve PSU's OVP value.

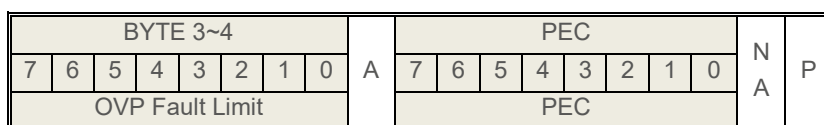
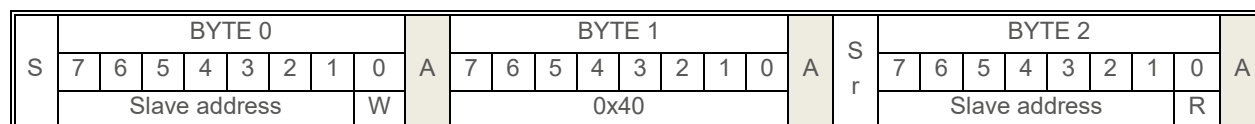

Example:

COMMAND	DESCRIPTION
10 40 11 18 01 98	OVP fault limit is 28.0V

Note:

- Slave address is assumed to be 0b0001000 in the example.
- Report data has two bytes and accuracy is one decimal place, the unit is Volt. Low byte is sent first, and then comes after the high byte.
- The value returned is the information of selected page, and for multi-output modules, the value is from selected phase.

4.9 Report OVP Fault Response

This command is for master device to retrieve PSU's OVP response.

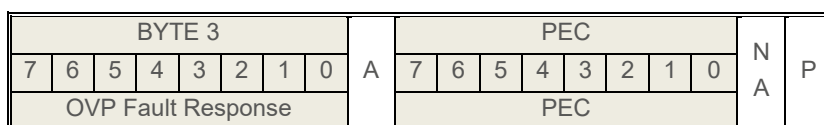
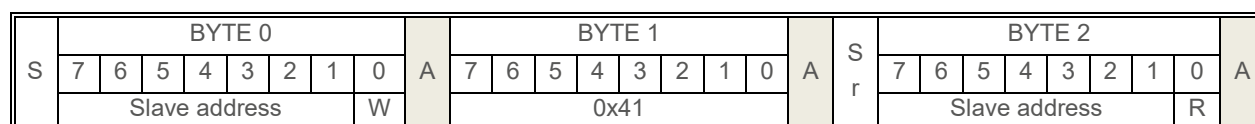

Range:

OVP Fault Response Definition:

BIT	MEANING
7~6	10 -- PSU latched / 11 -- PSU auto restart when fault recovered
5~0	TBD

Example:

COMMAND	DESCRIPTION
10 41 11 80 41	PSU is latched when OVP happened

Note:

- Slave address is assumed to be 0b0001000 in the example.
- The value returned is the information of all pages.

Medical / Industrial AC-DC Configurable Power Supply

Up to 2100W / MEG-A series

4.10 Report UVP Fault Limit

This command is for master device to retrieve PSU's UVP value.

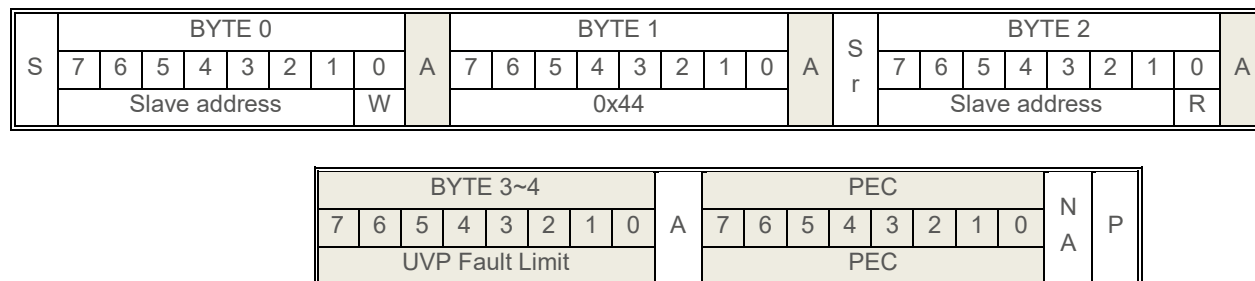

Example:

COMMAND	DESCRIPTION
10 44 11 B4 00 23	UVP fault limit is 18.0V

Note:

- Slave address is assumed to be 0b0001000 in the example.
- Report data has two bytes and accuracy is one decimal place, the unit is Volt. Low byte is sent first, and then comes after the high byte.
- The value returned is the information of selected page, and for multi-output modules, the value is from selected phase.

4.11 Report UVP Fault Response

This command is for master device to retrieve PSU's UVP response.

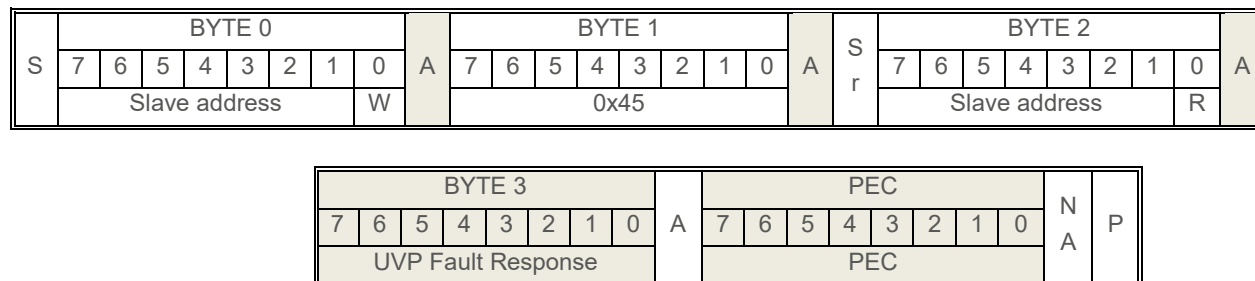

Range:

UVP Fault Response Definition:

BIT	MEANING
7~6	10 -- PSU latched / 11 -- PSU auto restart when fault recovered
5~0	TBD

Example:

COMMAND	DESCRIPTION
10 45 11 C0 2D	PSU auto restart when UVP removed

Note:

- Slave address is assumed to be 0b0001000 in the example.
- The value returned is the information of all pages.

Medical / Industrial AC-DC Configurable Power Supply

Up to 2100W / MEG-A series

4.12 Report OTP Fault Limit

This command is for master device to retrieve PSU's OTP value.

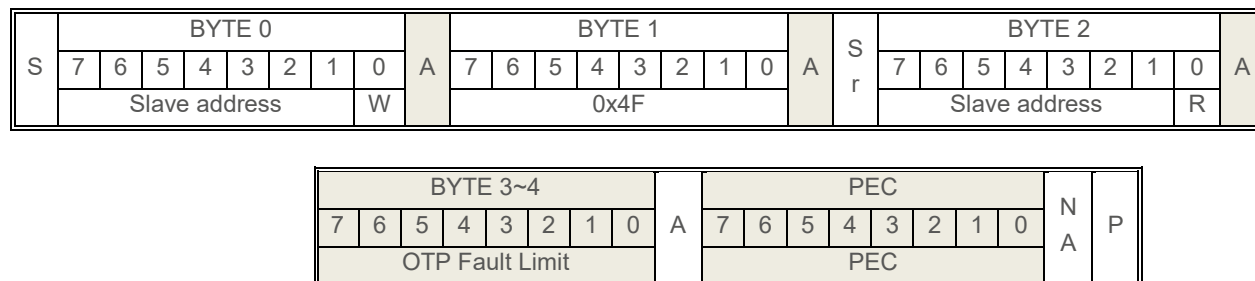

Example:

COMMAND	DESCRIPTION
10 4F 11 7E 04 DA	OTP fault limit is 115.0°C

Note:

- Slave address is assumed to be 0b0001000 in the example.
- Report data has two bytes and accuracy is one decimal place, the unit is Volt. Low byte is sent first, and then comes after the high byte.
- The value returned is the information of selected page, and for multi-output modules, the value is from selected phase.

4.13 Report OTP Fault Response

This command is for master device to retrieve PSU's OTP response.

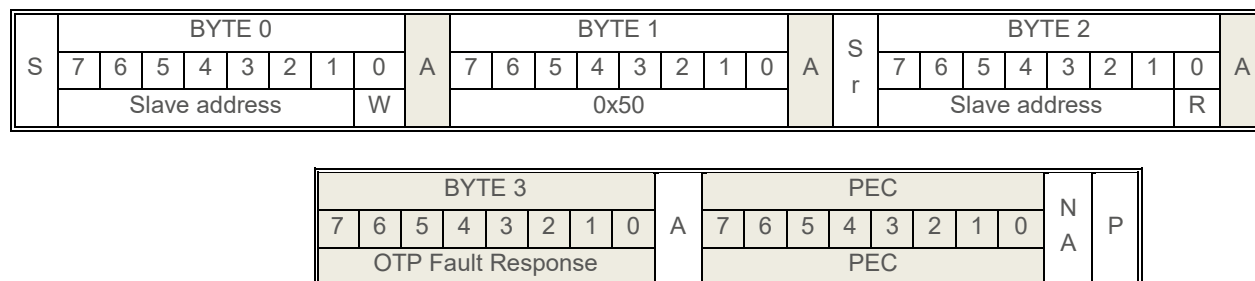

Range:

OTP Fault Response Definition:

BIT	MEANING
7~6	10 -- PSU latched / 11 -- PSU auto restart when fault recovered
5~0	TBD

Example:

COMMAND	DESCRIPTION
10 50 11 80 41	PSU is latched when OTP happened

Note:

- Slave address is assumed to be 0b0001000 in the example.
- The value returned is the information of all pages.

Medical / Industrial AC-DC Configurable Power Supply

Up to 2100W / MEG-A series

4.14 Report Status Byte

This command is for master device to retrieve one byte of information with a summary of the most critical faults in PSU.

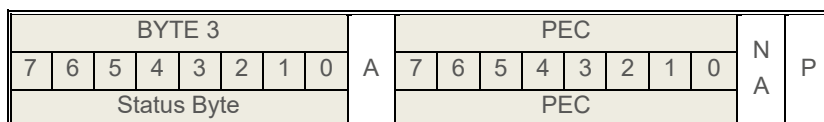
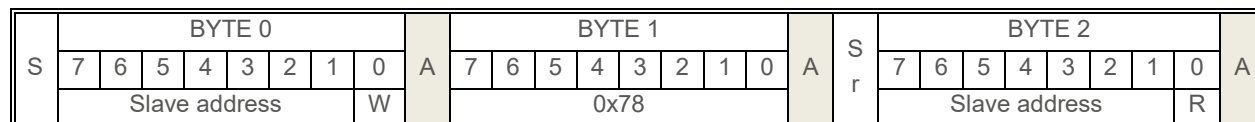

Range:

Status Byte Definition:

BIT	MEANING
7	0 -- PSU normal / 1 -- PSU busy
6	0 -- PSU normal / 1 -- PSU power off
5	0 -- PSU normal / 1 -- PSU OVP fault
4	0 -- PSU normal / 1 -- PSU OCP fault
3	0 -- PSU normal / 1 -- PSU input under-voltage fault
2	0 -- PSU normal / 1 -- PSU temperature related fault
1	0 -- PSU normal / 1 -- PSU CML related fault
0	0 -- PSU normal / 1 -- None of the above

Example:

COMMAND	DESCRIPTION
10 78 11 00 13	PSU has no faults

Note:

1. Slave address is assumed to be 0b0001000 in the example.
2. The value returned is the information of selected page, and for multi-output modules, the value is from selected phase.

4.15 Report Status Word

This command is for master device to retrieve two bytes of information with a summary of faults in PSU.

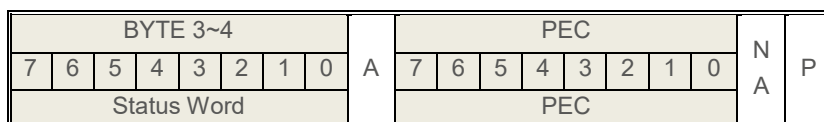
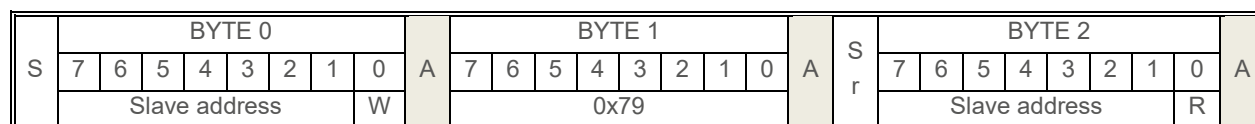

Medical / Industrial AC-DC Configurable Power Supply

Up to 2100W / MEG-A series

Range:

Status Word Definition:

BIT	MEANING
15	0 -- PSU normal / 1 -- PSU voltage related fault
14	0 -- PSU normal / 1 -- PSU current or power related fault
13	0 -- PSU normal / 1 -- PSU input related fault
12	0 -- PSU normal / 1 -- PSU manufacturer specific fault
11	0 -- PSU normal / 1 -- PSU power good signal fault
10	0 -- PSU normal / 1 -- PSU fan related fault
9	0 -- PSU normal / 1 -- Other fault
8	0 -- PSU normal / 1 -- PSU unknown fault
7	0 -- PSU normal / 1 -- PSU busy
6	0 -- PSU normal / 1 -- PSU power off
5	0 -- PSU normal / 1 -- PSU OVP fault
4	0 -- PSU normal / 1 -- PSU OCP fault
3	0 -- PSU normal / 1 -- PSU input under-voltage fault
2	0 -- PSU normal / 1 -- PSU temperature related fault
1	0 -- PSU normal / 1 -- PSU CML related fault
0	0 -- PSU normal / 1 -- None of the above

Example:

COMMAND	DESCRIPTION
10 79 11 00 00 6F	PSU has no faults

Note:

1. Slave address is assumed to be 0b0001000 in the example.
2. The value returned is the information of selected page, and for multi-output modules, the value is from selected phase.

4.16 Report Vout Status

This command is for master device to retrieve one byte of information with a summary of output voltage related faults in PSU.

S	BYTE 0								A	BYTE 1								A	S	BYTE 2								A
	7	6	5	4	3	2	1	0		7	6	5	4	3	2	1	0			7	6	5	4	3	2	1	0	
	Slave address								W	0x7A										Slave address								R

BYTE 3								A	PEC								N	A	P
7	6	5	4	3	2	1	0		7	6	5	4	3	2	1	0			
Vout Status									PEC										

Medical / Industrial AC-DC Configurable Power Supply

Up to 2100W / MEG-A series

Range:

Vout Status Definition:

BIT	MEANING
7	0 -- PSU normal / 1 -- PSU OVP fault
6	0 -- PSU normal / 1 -- PSU OVP warning
5	0 -- PSU normal / 1 -- PSU UVP warning
4	0 -- PSU normal / 1 -- PSU UVP fault
3	0 -- PSU normal / 1 -- PSU voltage reference range invalid
2	TBD
1	TBD
0	TBD

Example:

COMMAND	DESCRIPTION
10 7A 11 00 C5	PSU has no faults

Note:

1. Slave address is assumed to be 0b0001000 in the example.
2. The value returned is the information of selected page, and for multi-output modules, the value is from selected phase.

4.17 Report Iout Status

This command is for master device to retrieve one byte of information with a summary of output current related faults in PSU.

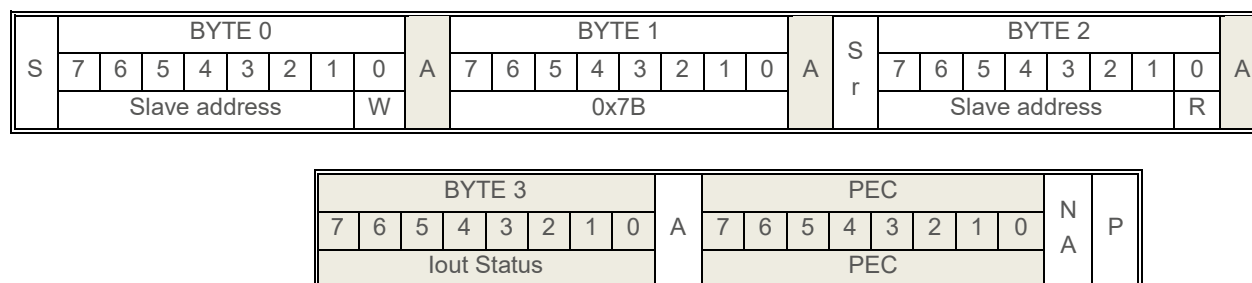
**Range:**

Iout Status Definition:

BIT	MEANING
7	0 -- PSU normal / 1 -- PSU OCP fault
6	TBD
5	0 -- PSU normal / 1 -- PSU OCP warning
4	0 -- PSU normal / 1 -- PSU UCP fault
3	0 -- PSU normal / 1 -- PSU current share fault
2	TBD
1	0 -- PSU normal / 1 -- PSU OPP fault
0	0 -- PSU normal / 1 -- PSU OPP warning

Example:

COMMAND	DESCRIPTION
10 7B 11 00 AE	PSU has no faults

Note:

1. Slave address is assumed to be 0b0001000 in the example.

Medical / Industrial AC-DC Configurable Power Supply

Up to 2100W / MEG-A series

2. The value returned is the information of selected page, and for multi-output modules, the value is from selected phase.

4.18 Report Temperature Status

This command is for master device to retrieve one byte of information with a summary of temperature related faults in PSU.

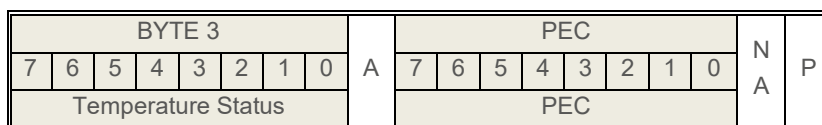
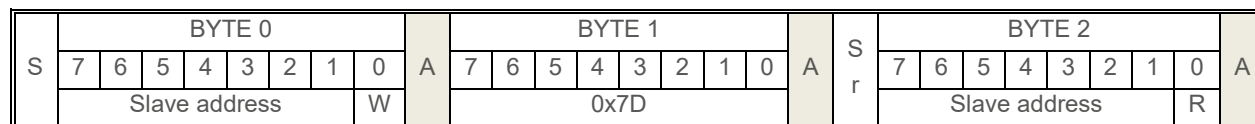

Range:

Temperature Status Definition:

BIT	MEANING
7	0 -- PSU normal / 1 -- PSU OTP fault
6	0 -- PSU normal / 1 -- PSU OTP warning
5	0 -- PSU normal / 1 -- PSU UTP fault
4	0 -- PSU normal / 1 -- PSU UTP warning
3	Reserved
2	Reserved
1	Reserved
0	Reserved

Example:

COMMAND	DESCRIPTION
10 7D 11 00 D3	PSU has no faults

Note:

1. Slave address is assumed to be 0b0001000 in the example.
2. The value returned is the information of selected page, and for multi-output modules, the value is from selected phase.

4.19 Report CML Status

This command is for master device to retrieve one byte of information with a summary of communications, logic and memory faults in PSU.

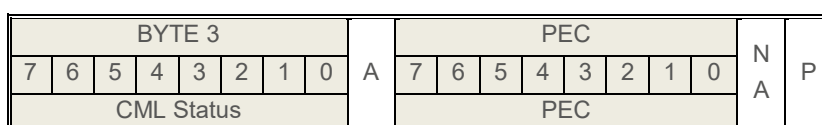
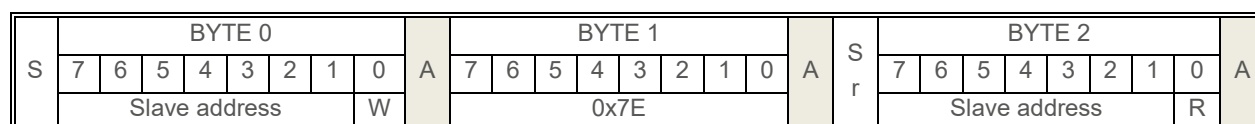

Medical / Industrial AC-DC Configurable Power Supply

Up to 2100W / MEG-A series

Range:

CML Status Definition:

BIT	MEANING
7	Invalid or unsupported command received
6	Invalid or unsupported data received
5	PEC check fail
4	Memory Fault Detected
3	Processor Fault Detected
2	Reserved
1	A communication fault other than the ones listed in this table has occurred
0	Other Memory Or Logic Fault has occurred.

Example:

COMMAND	DESCRIPTION
10 7E 11 00 6E	PSU has no faults

Note:

1. Slave address is assumed to be 0b0001000 in the example.
2. The value returned is the information of all pages.

4.20 Report Manufacturer Specific Status

This command is for master device to retrieve one byte of information with a summary of manufacturer specific faults in PSU.

S	BYTE 0								A	BYTE 1								A	S	BYTE 2								A
	7	6	5	4	3	2	1	0		7	6	5	4	3	2	1	0			7	6	5	4	3	2	1	0	
	Slave address								W	0x80										Slave address								R

BYTE 3								A	PEC								N	A	P
7	6	5	4	3	2	1	0		7	6	5	4	3	2	1	0			
MFR Specific Status									PEC										

Range:

MEB-1K2A series:

BIT	MEANING
7	0 -- PSU normal / 1 -- PSU current reference range invalid
6	0 -- PSU normal / 1 -- PSU AC OK lost
5	0 -- PSU normal / 1 -- PSU AC brown out
4	0 -- PSU normal / 1 -- PSU hardware fault
3	Reserved
2	Reserved
1	Reserved
0	Reserved

Example:

COMMAND	DESCRIPTION
10 80 11 00 2E	PSU has no faults

Note:

1. Slave address is assumed to be 0b0001000 in the example.
2. The value returned is the information of selected page, and for multi-output modules, the value is from selected phase.

Medical / Industrial AC-DC Configurable Power Supply

Up to 2100W / MEG-A series

4.21 Report Fan Status

This command is for master device to retrieve one byte of information with a summary of fan related faults in PSU.

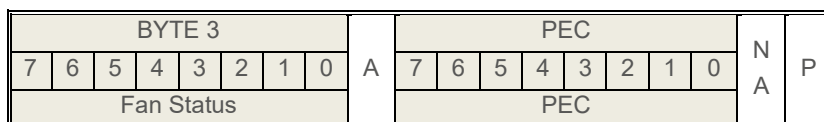
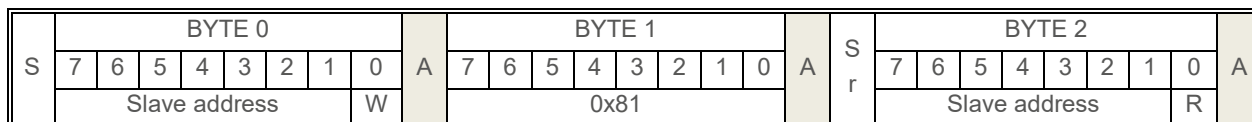

Range:

Fan Status Definition:

BIT	MEANING
7	0 -- PSU normal / 1 -- PSU fan1 fault
6	0 -- PSU normal / 1 -- PSU fan2 fault
5	TBD
4	TBD
3	TBD
2	TBD
1	TBD
0	TBD

Example:

COMMAND	DESCRIPTION
10 81 11 00 45	PSU has no faults

Note:

- Slave address is assumed to be 0b0001000 in the example.
- The value returned is the information of the whole PSU regardless of selected page.

4.22 Report Output Voltage

This command is for master device to retrieve PSU's output voltage.

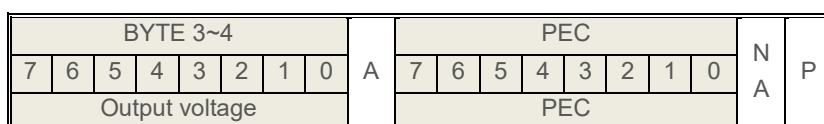
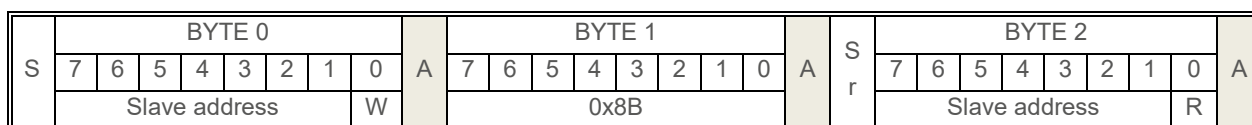

Example:

COMMAND	DESCRIPTION
10 8B 11 4A 01 9E	Output voltage is 33.0V

Note:

- Slave address is assumed to be 0b0001000 in the example.

Medical / Industrial AC-DC Configurable Power Supply

Up to 2100W / MEG-A series

- Report data has two bytes and accuracy is one decimal place, the unit is Volt. Low byte is sent first, and then comes after the high byte.
- The value returned is the information of selected page, and for multi-output modules, the value is from selected phase.

4.23 Report Output Current

This command is for master device to retrieve PSU's output current.

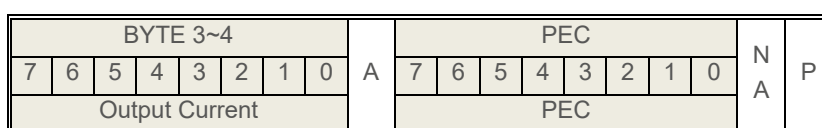
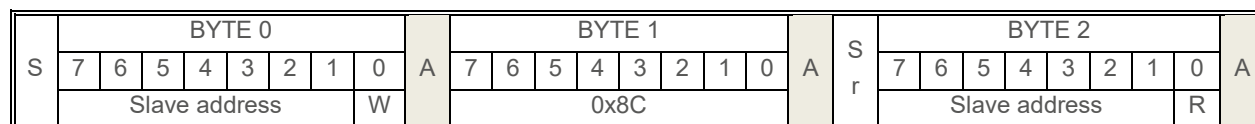

Example:

COMMAND	DESCRIPTION
10 8C 11 4A 01 FC	Output current is 33.0A

Note:

- Slave address is assumed to be 0b0001000 in the example.
- Report data has two bytes and accuracy is one decimal place, the unit is Ampere. Low byte is sent first, and then comes after the high byte.
- The value returned is the information of selected page, and for multi-output modules, the value is from selected phase.

4.24 Report Temperature

This command is for master device to retrieve PSU's temperature.

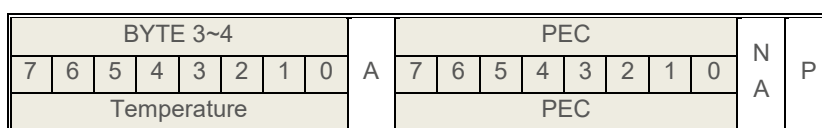
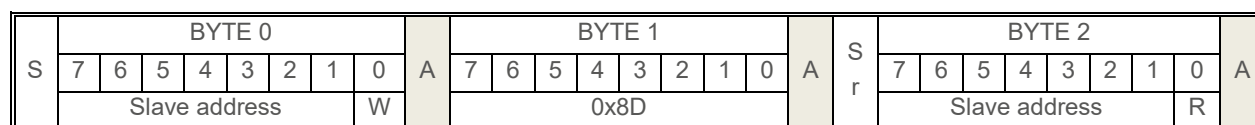

Example:

COMMAND	DESCRIPTION
10 8D 11 4A 01 EA	Temperature is 33.0°C

Note:

- Slave address is assumed to be 0b0001000 in the example.
- Report data has two bytes and accuracy is one decimal place, the unit is °C. Low byte is sent first, and then comes after the high byte, the value may be below 0.
- The value returned is the information of selected page, and for multi-output modules, the value is from selected phase.

Medical / Industrial AC-DC Configurable Power Supply

Up to 2100W / MEG-A series

4.25 Report Fan Speed 1/2

This command is for master device to retrieve PSU's fan speed in R.P.M.

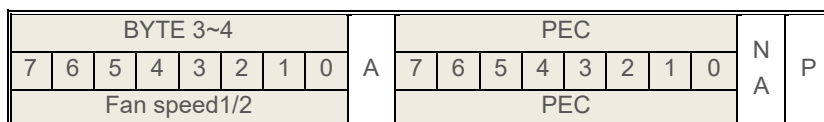
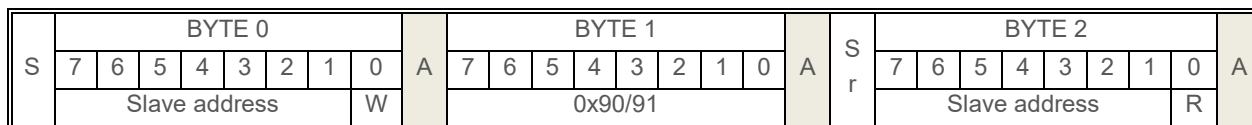

Example:

COMMAND	DESCRIPTION
10 90 11 58 1B 48	Fan speed is 7000 rpm

Note:

1. Slave address is assumed to be 0b0001000 in the example.
2. Report data has two bytes and the unit is rpm. Low byte is sent first, and then comes after the high byte.
3. The value returned is the information of all pages.

4.26 Report Output Power

This command is for master device to retrieve PSU's output power.

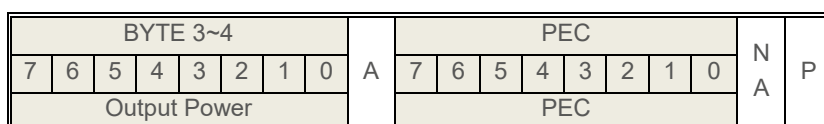
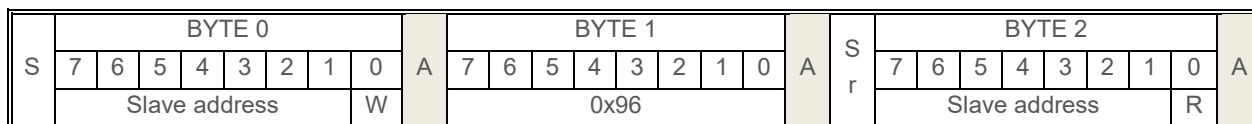

Example:

COMMAND	DESCRIPTION
10 96 11 E0 2E 50	Output power is 1200.0W

Note:

1. Slave address is assumed to be 0b0001000 in the example.
2. Report data has two bytes and accuracy is one decimal place, the unit is W. Low byte is sent first, and then comes after the high byte.
3. The value returned is the information of all pages.

Medical / Industrial AC-DC Configurable Power Supply

Up to 2100W / MEG-A series

4.27 Report PMBus Revision

This command is for master device to retrieve PMBus revision.

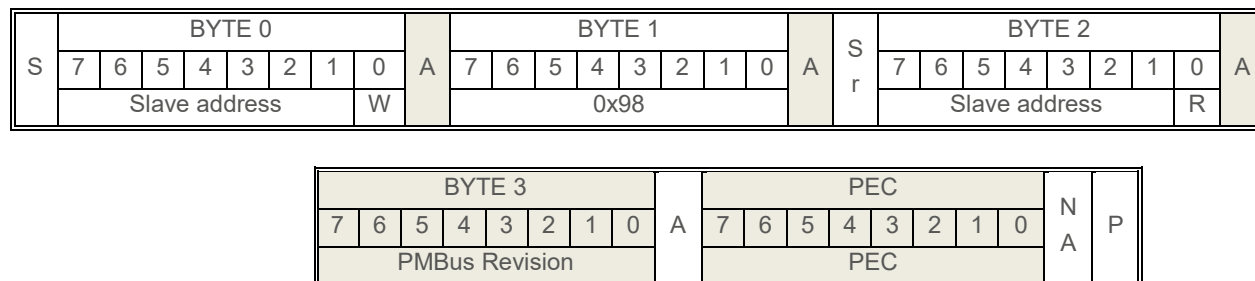

Example:

COMMAND	DESCRIPTION
10 98 11 33 44	PMBus Part I and II revision is 1.3

Note:

1. Slave address is assumed to be 0b0001000 in the example.
2. The high 4-bit represents PMBus part I, and the low 4-bit represents PMBus part II.
3. The value returned is the information of all pages.

4.28 Report Manufacturer ID

This command is for master device to retrieve manufacturer information.

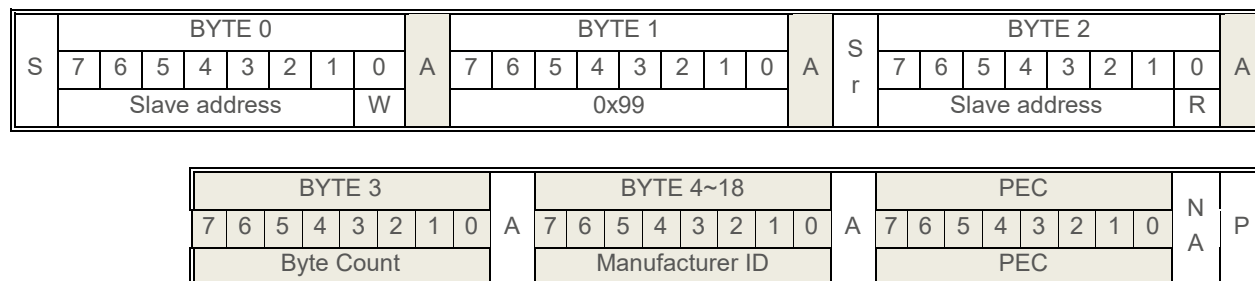

Range:

Manufacturer ID: 15 bytes of ASCII code

Example:

COMMAND	DESCRIPTION
10 99 11 0F 20 20 20 20 20 20 45 42 4E 2D 41 54 4C 45 44 CB	Manufacturer is DELTA-NBE

Note:

1. Slave address is assumed to be 0b0001000 in the example.
2. The value returned is the information of all pages
3. If the version length is smaller than 15, padding the other bytes with 0x20

Medical / Industrial AC-DC Configurable Power Supply

Up to 2100W / MEG-A series

4.29 Report Manufacturer Model Name

This command is for master device to retrieve PSU's model name.

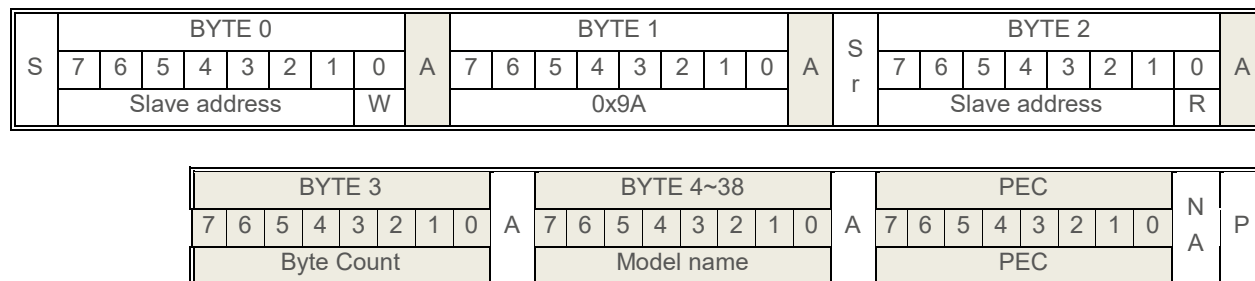

Range:

Model name: 34 bytes of ASCII code

Example:

COMMAND	DESCRIPTION
10 9A 11 0F D4	Model name is MEG-2K1A6C O1-O1-O1-O1-O1-O1 000AA

Note:

1. Slave address is assumed to be 0b0001000 in the example.
2. The value returned is the information of all pages.
3. The detailed information please see the Chapter 2.1 Order Information.
4. If the version length is smaller than 34, padding the other bytes with 0x20.

4.30 Report Manufacturer Version

This command is for master device to retrieve PSU's version.

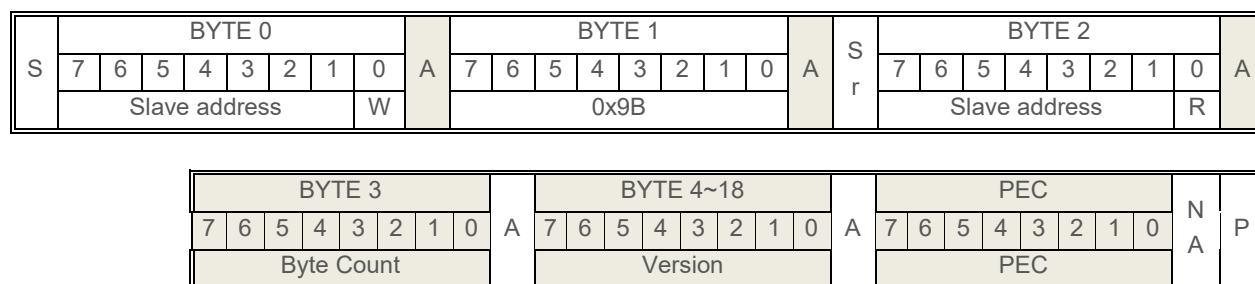

Range:

Manufacturer version: 15 bytes of ASCII code

Example:

COMMAND	DESCRIPTION
10 9B 11 0F 20 20 20 20 20 20 20 20 20 20 30 30 45 30 30 53 8E	Version is S00E00

Note:

1. Slave address is assumed to be 0b0001000 in the example.
2. The value returned is the information of all pages.
3. If the version length is smaller than 15, padding the other bytes with 0x20.

Medical / Industrial AC-DC Configurable Power Supply

Up to 2100W / MEG-A series

4.31 Report Manufacturer Serial Number

This command is for master device to retrieve PSU's serial number.

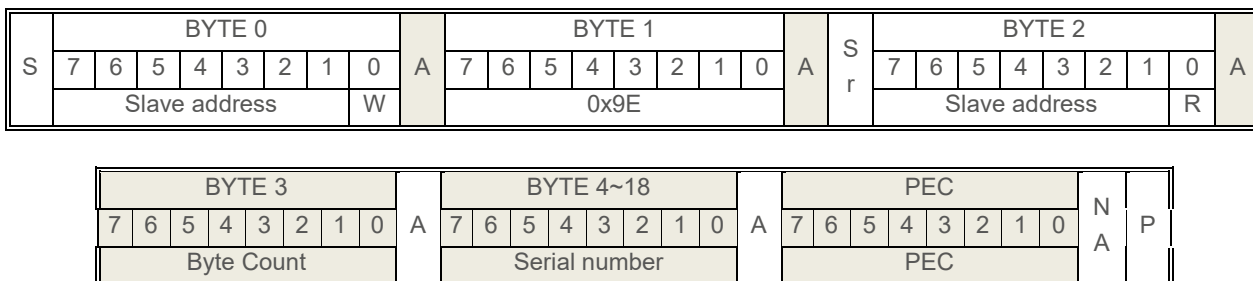

Range:

Serial number: 15 bytes of ASCII code

Example:

COMMAND	DESCRIPTION
10 9E 11 0F 20 20 20 30 31 32 33 34 35 36 37 38 39 41 42 88	Serial number is BA9876543210

Note:

1. Slave address is assumed to be 0b0001000 in the example.
2. The value returned is the information of all pages
3. If the version length is smaller than 15, padding the other bytes with 0x20

4.32 Report Max Rated Voltage

This command is for master device to retrieve PSU's max rated voltage value.

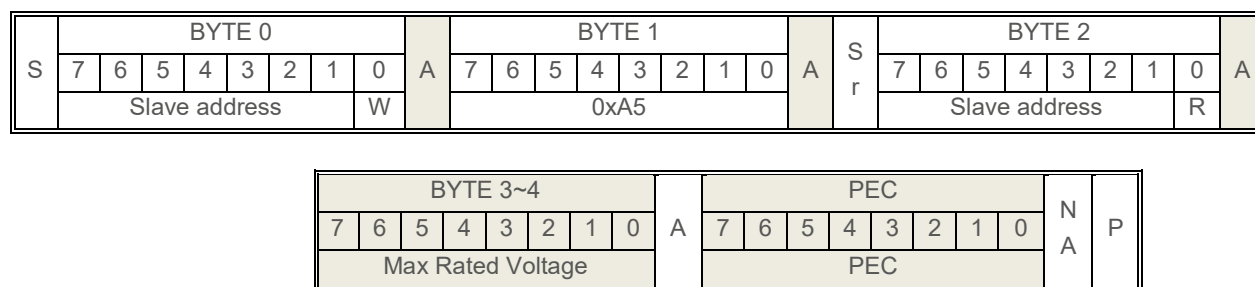

Example:

COMMAND	DESCRIPTION
10 A5 11 08 01 50 E5	Max rated voltage is 26.4V

Note:

1. Slave address is assumed to be 0b0001000 in the example.
2. Report data has two bytes and accuracy is one decimal place, the unit is Volt. Low byte is sent first, and then comes after the high byte.
3. The value returned is the information of selected page, and for multi-output modules, the value is from selected phase.

Medical / Industrial AC-DC Configurable Power Supply

Up to 2100W / MEG-A series

4.33 Report Max Rated Current

This command is for master device to retrieve PSU's max rated current value.

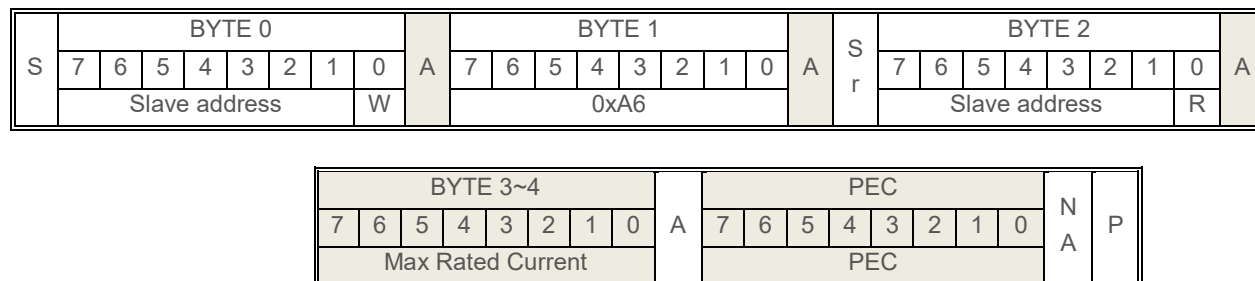

Example:

COMMAND	DESCRIPTION
10 A6 11 26 02 AE	Max rated current is 55.0A

Note:

1. Slave address is assumed to be 0b0001000 in the example.
2. Report data has two bytes and accuracy is one decimal place, the unit is Ampere. Low byte is sent first, and then comes after the high byte.
3. The value returned is the information of selected page, and for multi-output modules, the value is from selected phase.

4.34 Report Max Rated Power

This command is for master device to retrieve PSU's max rated power value.

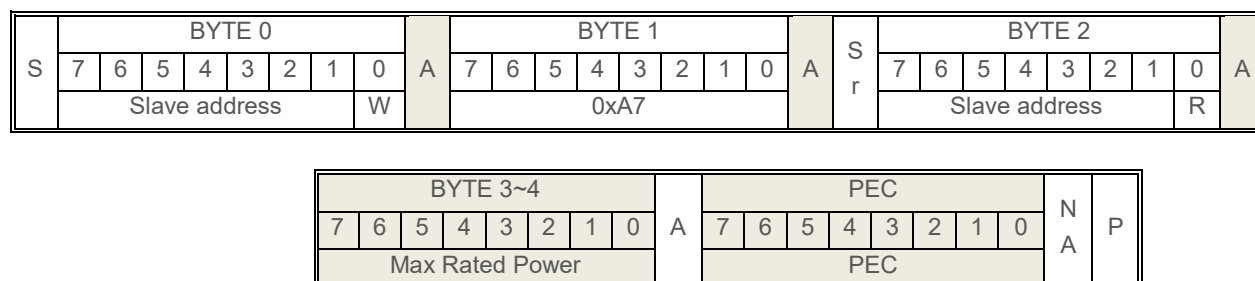

Example:

COMMAND	DESCRIPTION
10 A7 11 E0 2E EF	Max rated power is 1200.0W

Note:

1. Slave address is assumed to be 0b0001000 in the example.
2. Report data has two bytes and accuracy is one decimal place, the unit is W. Low byte is sent first, and then comes after the high byte.
3. The value returned is the information of selected page, and for multi-output modules, the value is from selected phase.

Medical / Industrial AC-DC Configurable Power Supply

Up to 2100W / MEG-A series

4.35 Report Max Rated Ambient Temperature

This command is for master device to retrieve PSU's max rated ambient temperature.

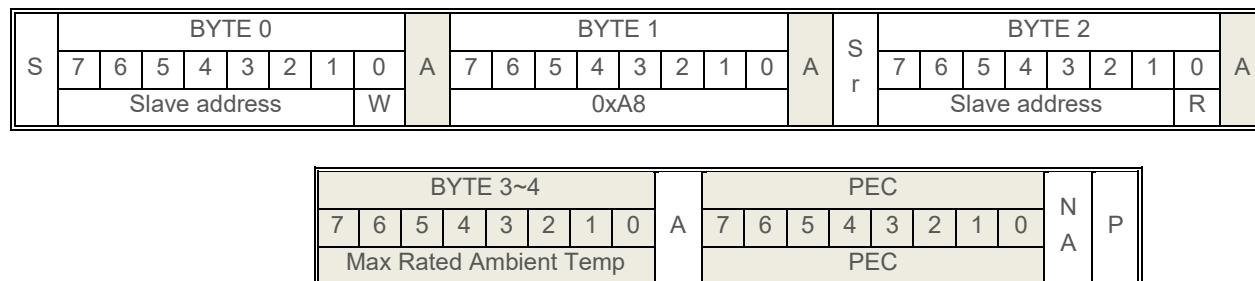

Example:

COMMAND	DESCRIPTION
10 A8 11 BC 02 09	Max rated ambient temperature is 70.0°C

Note:

- Slave address is assumed to be 0b0001000 in the example.
- Report data has two bytes and accuracy is one decimal place, the unit is °C. Low byte is sent first, and then comes after the high byte.
- The value returned is the information of selected page, and for multi-output modules, the value is from selected phase.

4.36 Report CC/CV Mode

This command is for master device to retrieve PSU's working status.

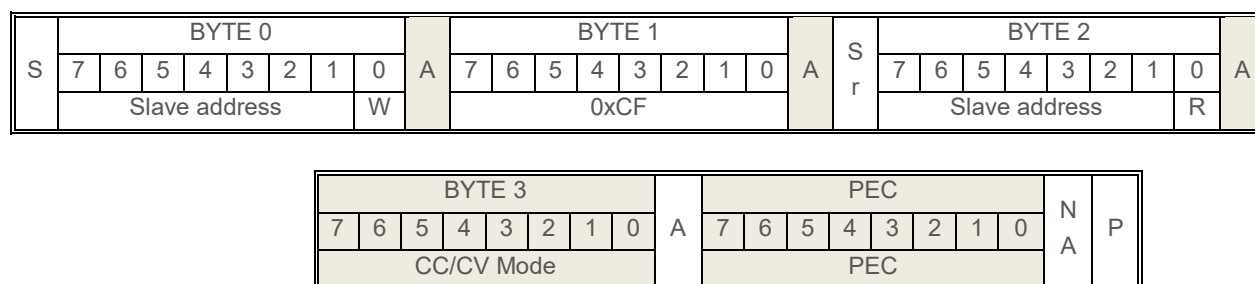

Range:

CC/CV Mode Definition:

VALUE	MEANING
0x00	CV Mode
0x01	CC Mode

Example:

COMMAND	DESCRIPTION
10 CF 11 00 EF	PSU is in CV mode.

Note:

- Slave address is assumed to be 0b0001000 in the example.
- The value returned is the information of selected page, and for multi-output modules, the value is from selected phase.
- There is only CV mode in this series, CC mode is reserved.

Medical / Industrial AC-DC Configurable Power Supply

Up to 2100W / MEG-A series

4.37 Report Page

This command serves as an index that can be used by many commands to distinguish between the modules. The table below is the page number which can be accessed through the Page command. The valid values for the Page register are from zero to six (0 to 6) and 0xFF (all page selected, only valid when received the OPERATION and CLEAR_FAULTS command). The default value is 0.

Module Position	Page number
Frame	0
DC/DC slot 1	1
DC/DC slot 2	2
DC/DC slot 3	3
DC/DC slot 4	4
DC/DC slot 5	5
DC/DC slot 6	6

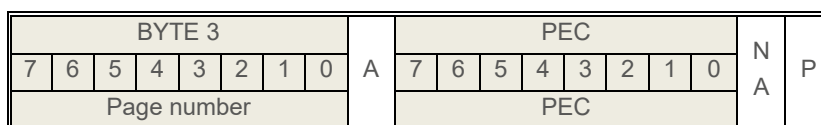
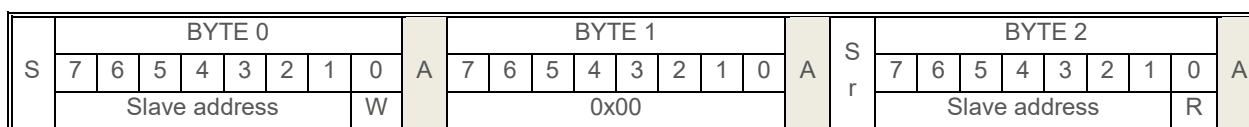

Example:

COMMAND	DESCRIPTION
10 00 11 00 25	The current selected page is 00

Note:

Slave address is assumed to be 0b0001000 in the example.

4.38 Report Operation

This function is for master device to get the module on/off status.

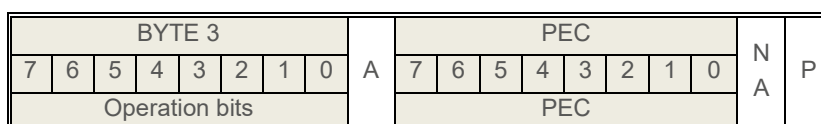
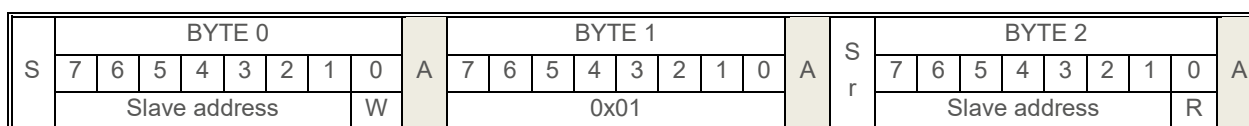

Range:

Operation bits:

BITS	MEANING
7	ON/OFF State:0—OFF 1--ON
6	Reserved
5	Reserved
4	Reserved

Medical / Industrial AC-DC Configurable Power Supply

Up to 2100W / MEG-A series

3	Reserved
2	Reserved
1	Reserved
0	Reserved

Example:

COMMAND	DESCRIPTION
10 01 11 00 4E	The module is turn off

Note:

- Slave address is assumed to be 0b0001000 in the example.
- The value returned is the information of selected page, and for multi-output modules, the value is from selected phase.

4.39 Report On Off Configure

This command can be used to get the information including how the PSU will be turned on by enabling the operation command or the global remote on/off signal, or both the polarity of the global remote on/off signal can also be set here. The on off configure flag for turn off delay and fall time (bit 0) is disregarded.

BYTE 0								A	BYTE 1								A	S	BYTE 2								A
7	6	5	4	3	2	1	0		7	6	5	4	3	2	1	0			7	6	5	4	3	2	1	0	
Slave address								W	0x02								R	Slave address								R	

BYTE 3								A	PEC								N	A	P
7	6	5	4	3	2	1	0		7	6	5	4	3	2	1	0			
on off configure bits								PEC											

Range:

on off configure bits

Bits	Value	Meaning
7:5	000	Reserved
4	0	Unit powers up any time power is present regardless of state of the Global inhibit pin
	1	Unit does not power up until commanded by the Global inhibit pin
3	0	Unit ignores the on/off portion of the OPERATION command from serial bus
	1	To start, the unit requires that the on/off portion of the OPERATION command is instructing the unit to run.
2	0	Unit ignores the Global inhibit pin
	1	Unit requires the Global inhibit pin to be asserted to start the unit.
1	0	Polarity of the Global inhibit pin(active low)
	1	Polarity of the Global inhibit pin(active high)
0	0	Use programmed turn off delay(not used)
	1	Stop as fast as possible

Example:

COMMAND	DESCRIPTION
10 02 11 15 98	The unit does not power up until commanded by the global inhibit pin is low, ignores the on/off portion of the operation command from serial bus. The unit would be stop as fast as possible without delay.

Medical / Industrial AC-DC Configurable Power Supply

Up to 2100W / MEG-A series

Note:

1. Slave address is assumed to be 0b0001000 in the example.
2. The value returned is the information of all pages.

4.40 Page Plus Read

The page plus read command is used to set the page within a device, send a command, and read the data for the command in one packet without send a page command first.

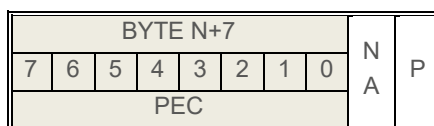
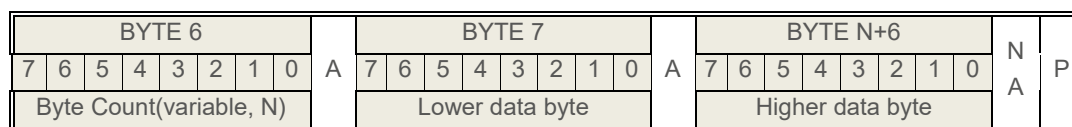
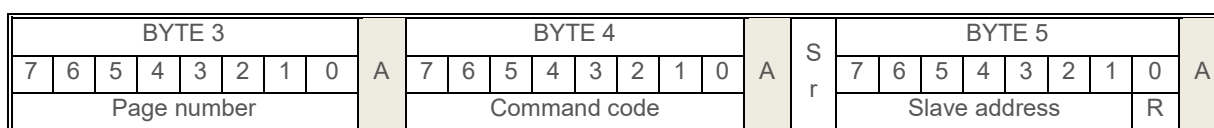
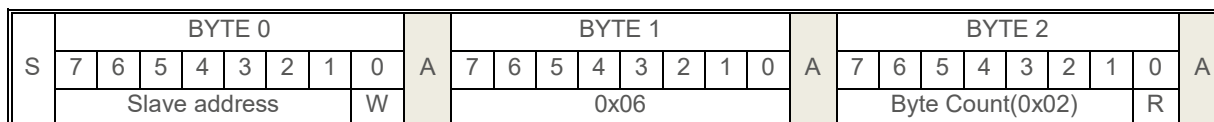
**Example:**

COMMAND	DESCRIPTION
10 06 02 00 02 11 01 15 32	Get the on/off configure value(0x02) of common frame, the return value is 0x15

Note:

1. Slave address is assumed to be 0b0001000 in the example.
2. The value returned is the information of selected page, and for multi-output modules, the value is from selected phase
3. This command would not change the current selected page in the PAGE command.

4.41 Report Write Protect

The write protect command is used to control writing to the PMBus device. The intent of this command is to provide protection against accidental changes. The command is described as below:

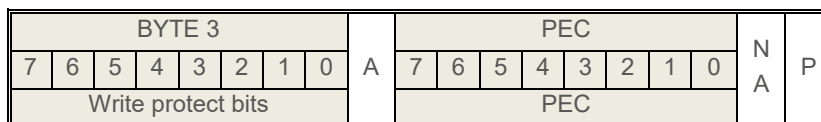
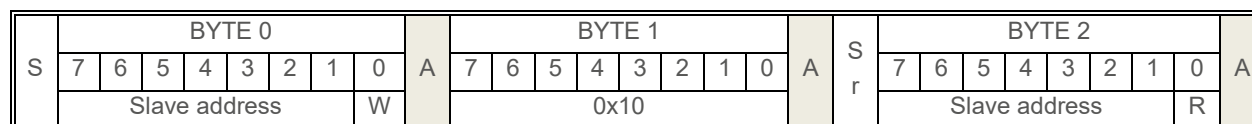

Medical / Industrial AC-DC Configurable Power Supply

Up to 2100W / MEG-A series

Range:

Write protect bits

Data byte	Description
1000 0000	Disable all writes except to the WRITE PROTECT command
0100 0000	Disable all writes except to the WRITE PROTECT, OPERATION and PAGE commands
0010 0000	Disable all writes except to the WRITE PROTECT, OPERATION, PAGE, ON OFF CONFIGURE and VOUT COMMAND commands
0000 0000	Enable writes to all commands

Example:

COMMAND	DESCRIPTION
10 10 11 00 87	The current writing status is 00 (Enable writes to all commands)

Note:

1. Slave address is assumed to be 0b0001000 in the example.
2. The value returned is the information of all pages.

4.42 Capability

This read only command provides a way for a host system to get some key capabilities of a PMBus device.

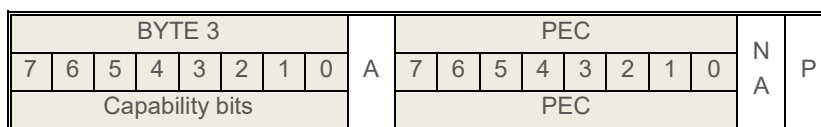
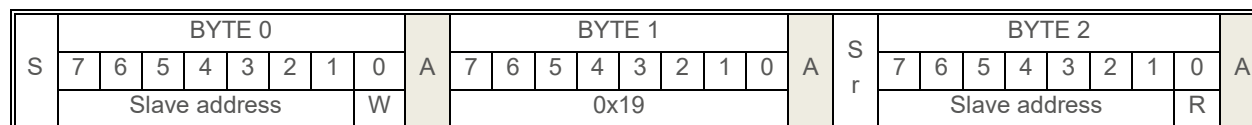
**Range:**

Capability bits

Bits	Description	Value	Meaning
7	PEC	0	PEC not supported
		1	PEC supported
6:5	Maximum bus speed	00	100kHz
		01	400kHz
4	PMBUS SMBALERT	0	Not supported
		1	Supported
3	Numeric format	0	Direct
2~0	Reserved		

Example:

COMMAND	DESCRIPTION
10 19 11 90 44	This unit is support PEC, speed 100kHz, support SMBALERT pin, numeric format is direct.

Note:

1. Slave address is assumed to be 0b0001000 in the example.
2. This command would report all the modules capability regardless of the selected page.

Medical / Industrial AC-DC Configurable Power Supply

Up to 2100W / MEG-A series

4.43 QUERY

The query command is used to ask a PMBus device if it supports a given command, and if so, what data formats it supports for that command.

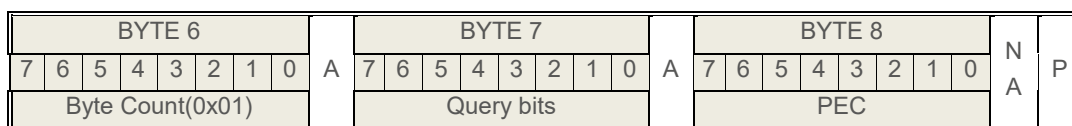
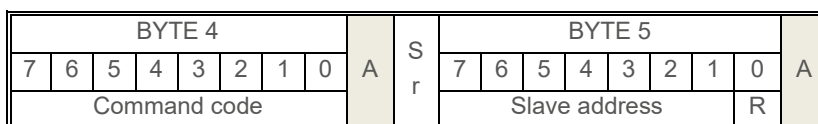
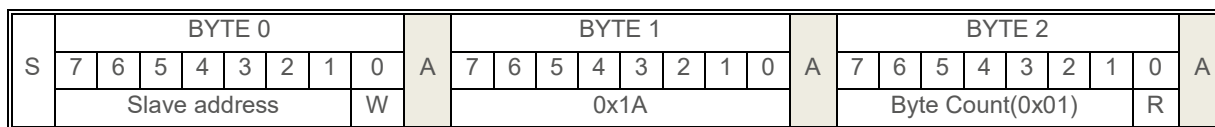

Range:

Query bits

Bits	Value	Meaning
7	0	Command not supported
	1	Command supported
6	0	Command not supported for write
	1	Command supported for write(regardless of WRITE_PROTECT)
5	0	Command not supported for read
	1	Command supported for read
4:2	000	LINEAR11, ULINEAR16, or SLINEAR16
	001	16 bit signed number
	011	Direct mode format
	100	8 bit unsigned number
	111	Command does not return numeric data.
1~0	XX	Reserved

Example:

COMMAND	DESCRIPTION
10 1A 01 21 11 01 EC BC	Get the Vout command query value, the return value is 0xEC, which is supported for read and write, number format is direct

Note:

1. Slave address is assumed to be 0b0001000 in the example.
2. This command would report all the modules value regardless of the selected page.

Medical / Industrial AC-DC Configurable Power Supply

Up to 2100W / MEG-A series

4.44 SMBALERT Mask

The SMBALERT Mask command may be used to report if a warning or fault condition could be asserting the PMBUS SMBALERT signal.

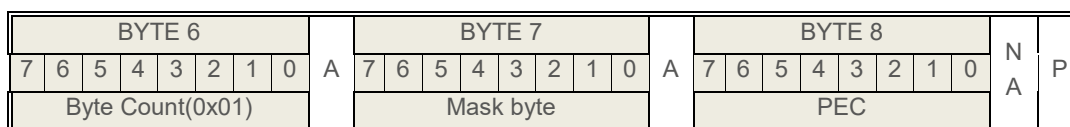
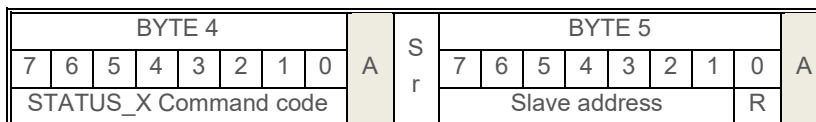
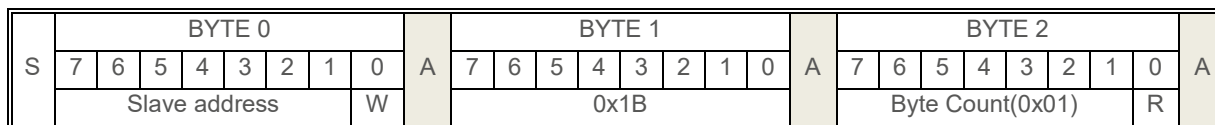

Example:

COMMAND	DESCRIPTION
10 1B 01 7A 11 01 00 69	None of the STATUS_VOUT bits would be blocked from asserting SMBALERT#.

Note:

1. Slave address is assumed to be 0b0001000 in the example.
2. This command would report all the modules value regardless of all pages.

4.45 Report Vin On

The Vin On command sets the value of the input voltage, in Volts, at which the unit should start power conversion.

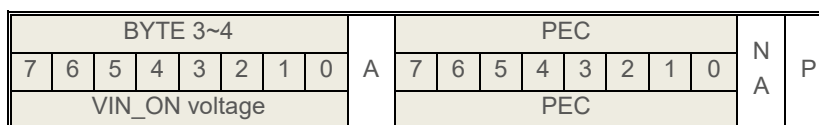
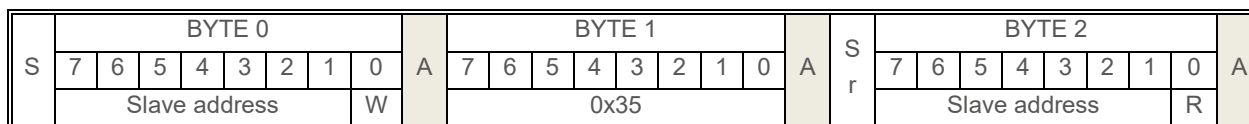

Example:

COMMAND	DESCRIPTION
10 35 11 52 03 33	Vin on voltage is 85.0V

Note:

1. Slave address is assumed to be 0b0001000 in the example.
2. Report data has two bytes and accuracy is one decimal place, the unit is Volt. Low byte is sent first, and then comes after the high byte.
3. The value returned is the information of all pages.

Medical / Industrial AC-DC Configurable Power Supply

Up to 2100W / MEG-A series

4.46 Report Vin Off

The Vin off command sets the value of the input voltage, in Volts, at which the unit, once operation has started, should stop power conversion.

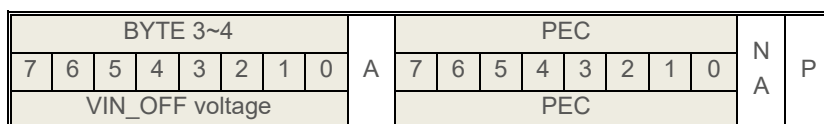
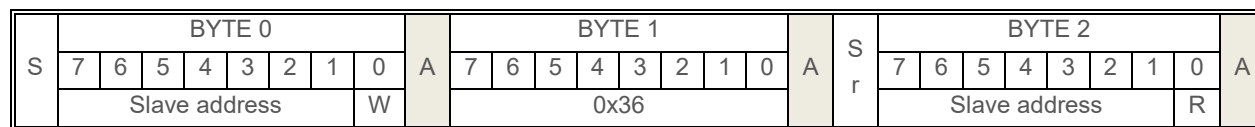

Example:

COMMAND	DESCRIPTION
10 36 11 EE 02 BD	VIN_OFF voltage is 75.0V

Note:

- Slave address is assumed to be 0b0001000 in the example.
- Report data has two bytes and accuracy is one decimal place, the unit is Volt. Low byte is sent first, and then comes after the high byte.
- The value returned is the information of all pages.

4.47 Report Vout UV Warn Limit

The Vout UV warn limit command sets the value of the PSU output voltage measured at the sense or output pins that causes an output under-voltage warning. This value is typically greater than the output under-voltage fault threshold. The data bytes are two bytes formatted according to the setting of the Vout mode command.

When the fault happens, the device may:

- Sets the NONE OF THE ABOVE bit in the STATUS_BYTE,,
- Sets the VOUT bit in the STATUS_WORD,
- Sets the VOUT_UV_WARN bit in the STATUS_VOUT register, and
- Notifies the host by SMLART# signal if supported

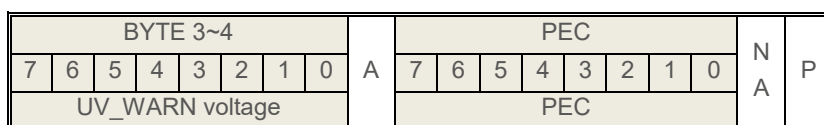
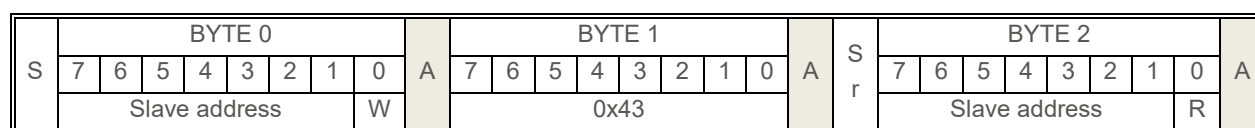

Example:

COMMAND	DESCRIPTION
10 43 11 96 00 C5	UV_WARN voltage is 15.0V

Note:

- Slave address is assumed to be 0b0001000 in the example.
- Report data has two bytes and accuracy is one decimal place, the unit is Volt. Low byte is sent first, and then comes after the high byte.
- The value returned is the information of page 0.

Medical / Industrial AC-DC Configurable Power Supply

Up to 2100W / MEG-A series

4.48 Report Iout OC Fault Limit

This command is for master device to retrieve PSU's Iout OC fault limit value.

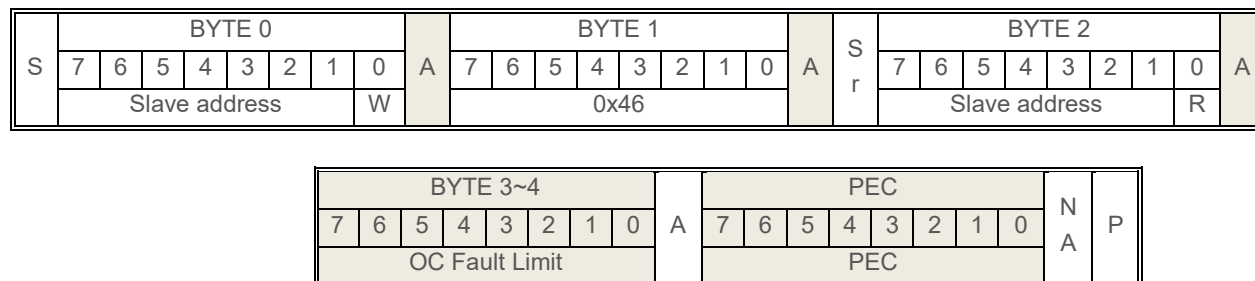

Example:

COMMAND	DESCRIPTION
10 46 11 96 00 8B	OC fault limit is 150.0A

Note:

1. Slave address is assumed to be 0b0001000 in the example.
2. Report data has two bytes and accuracy is one decimal place, the unit is Volt. Low byte is sent first, and then comes after the high byte.
3. The value returned is the information of selected page, and for multi-output modules, the value is from selected phase.

4.49 Report IOUT OC Fault Response

This command is for master device to retrieve PSU's OC response.

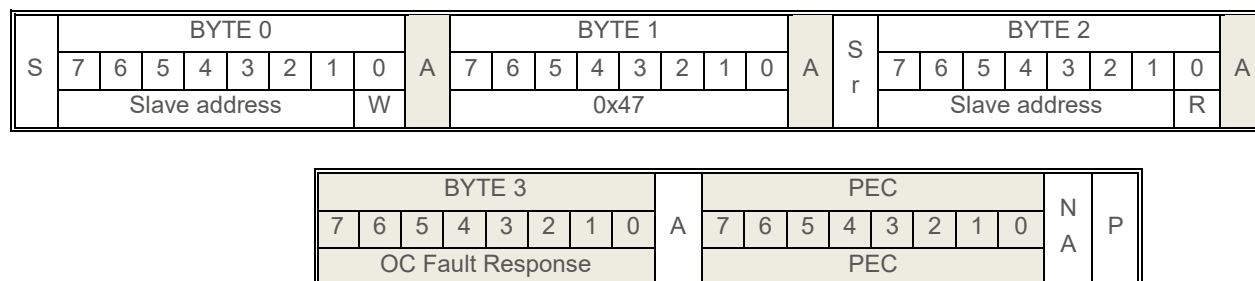

Range:

OC Fault Response Definition:

BIT	MEANING
7~6	10 -- PSU latched / 11 -- PSU auto restart when fault recovered
5~0	TBD

Example:

COMMAND	DESCRIPTION
10 47 11 80 3C	PSU is latched when OC happened

Note:

1. Slave address is assumed to be 0b0001000 in the example.
2. The value returned is the information of all pages.

Medical / Industrial AC-DC Configurable Power Supply

Up to 2100W / MEG-A series

4.50 Report UTP Fault Limit

This command is for master device to retrieve PSU's UTP value.

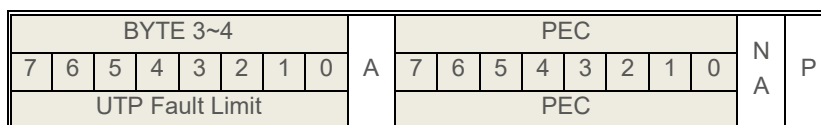
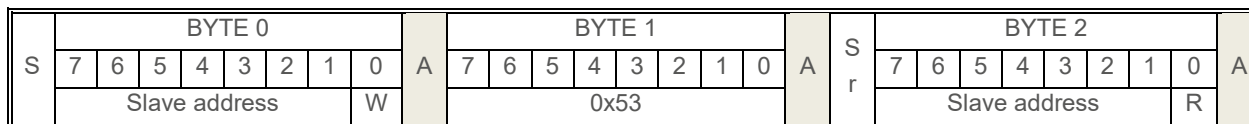

Example:

COMMAND	DESCRIPTION
10 53 11 00 00 3D	UTP fault limit is 0°C

Note:

- Slave address is assumed to be 0b0001000 in the example.
- Report data has two bytes and accuracy is one decimal place, the unit is °C. Low byte is sent first, and then comes after the high byte the value may be below 0.
- The value returned is the information of selected page, and for multi-output modules, the value is from selected phase.

4.51 Report UTP Fault Response

This command is for master device to retrieve PSU's UTP response.

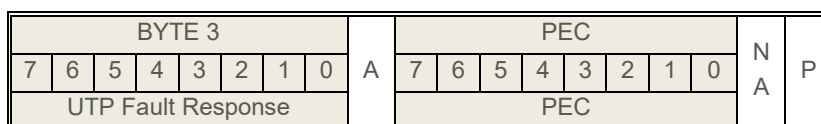
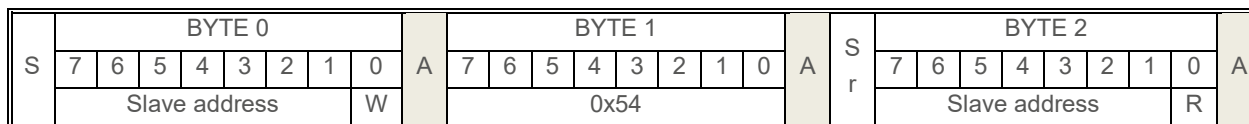

Range:

UTP Fault Response Definition:

BIT	MEANING
7~6	10 -- PSU latched / 11 -- PSU auto restart when fault recovered
5~0	TBD

Example:

COMMAND	DESCRIPTION
10 54 11 80 23	PSU is latched when UTP happened

Note:

- Slave address is assumed to be 0b0001000 in the example.
- The value returned is the information of all pages.

Medical / Industrial AC-DC Configurable Power Supply

Up to 2100W / MEG-A series

4.52 Report Input Voltage

This command is for master device to retrieve PSU's input voltage.

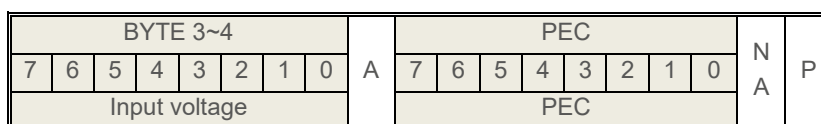
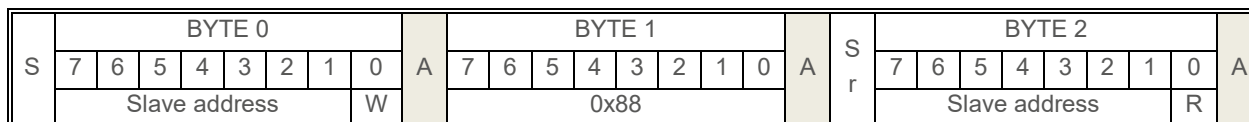

Example:

COMMAND	DESCRIPTION
10 88 11 98 08 0B	Input voltage is 220.0V

Note:

1. Slave address is assumed to be 0b0001000 in the example.
2. Report data has two bytes and accuracy is one decimal place, the unit is Volt. Low byte is sent first, and then comes after the high byte.
3. This command would report the whole product value regardless of the selected page.

4.53 Report Output Power

This command is for master device to retrieve PSU's output power.

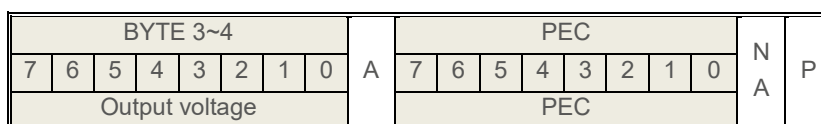
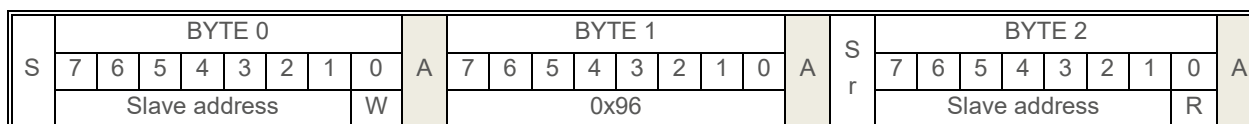

Example:

COMMAND	DESCRIPTION
10 96 11 98 08 0B	Output power is 220.0W

Note:

1. Slave address is assumed to be 0b0001000 in the example.
2. Report data has two bytes and accuracy is one decimal place, the unit is Volt. Low byte is sent first, and then comes after the high byte.
3. This command would report the total output value regardless of the selected page.

Medical / Industrial AC-DC Configurable Power Supply

Up to 2100W / MEG-A series

4.54 Report Frame Firmware Version

This command is for master device to retrieve PSU's version.

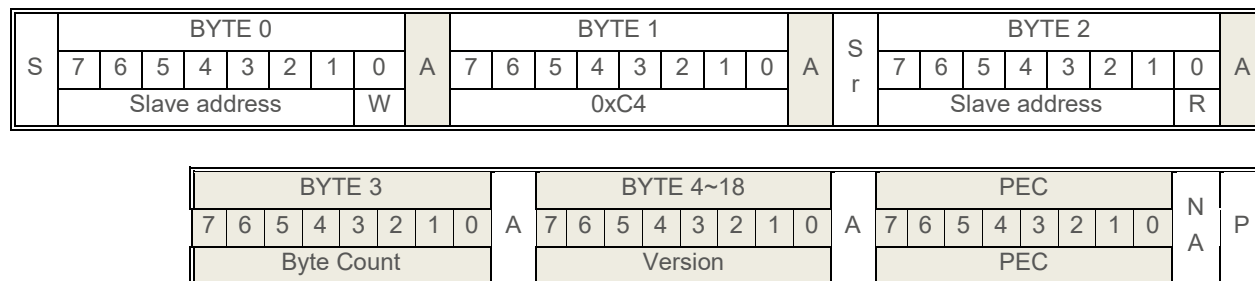

Range:

Frame Firmware Version: 15 bytes of ASCII code

Example:

COMMAND	DESCRIPTION
10 C4 11 0F 20 20 20 20 20 20 20 20 20 30 30 45 30 30 53 17	Version is S00E00

Note:

1. Slave address is assumed to be 0b0001000 in the example
2. The message is in inverted order, if the version length is smaller than 15, padding the other bytes with 0x20.
3. This command would report the frame version regardless of the selected page.

4.55 Report Module Firmware Version

This command is for master device to retrieve PSU's module version.

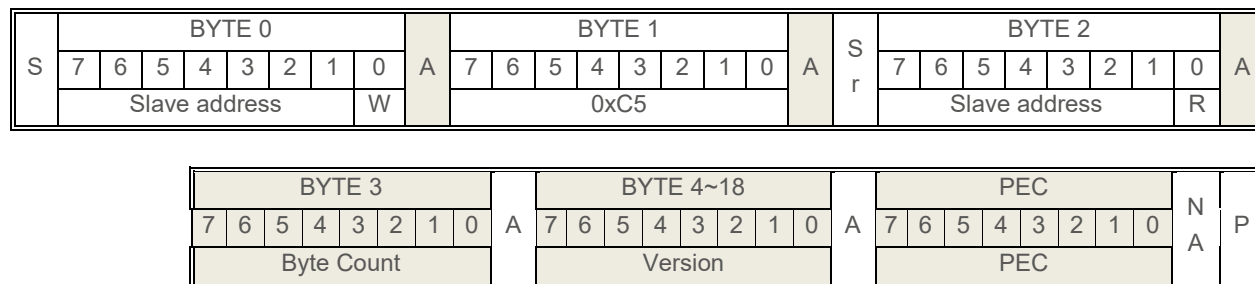

Range:

Module Firmware Version: 15 bytes of ASCII code

Example:

COMMAND	DESCRIPTION
10 C5 11 0F 20 20 20 20 20 20 20 20 20 30 30 45 30 30 53 3D	Version is S00E00

Note:

1. Slave address is assumed to be 0b0001000 in the example.
2. The value returned is the information of selected page, and for multi-output modules, the value is from selected phase.
3. The message is in inverted order, if the version length is smaller than 15, padding the other bytes with 0x20.

Medical / Industrial AC-DC Configurable Power Supply

Up to 2100W / MEG-A series

4.56 Report Module Serial Number

This command is for master device to retrieve PSU's module serial number.

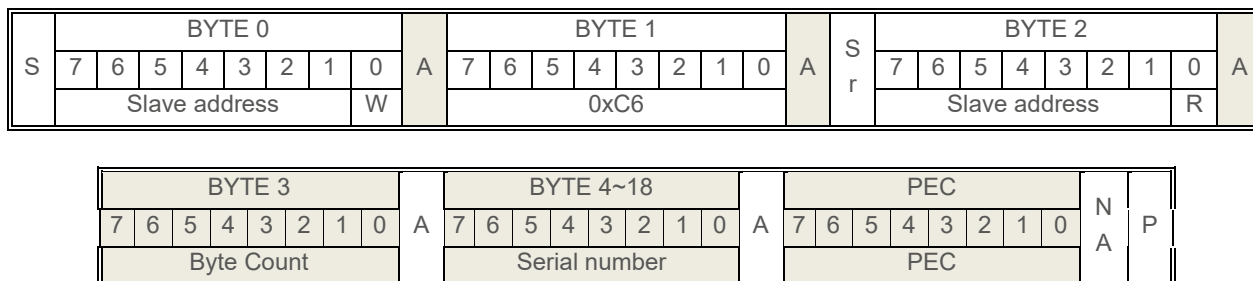

Range:

Serial number: 15 bytes of ASCII code

Example:

COMMAND	DESCRIPTION
10 C6 11 0F 20 20 20 30 31 32 33 34 35 36 37 38 39 41 42 C7	Serial number is BA9876543210

Note:

1. Slave address is assumed to be 0b0001000 in the example.
2. The value returned is the information of selected page, and for multi-output modules, the value is from selected phase.
3. The message is in inverted order, if the version length is smaller than 15, padding the other bytes with 0x20

4.57 Report Module Model Name

This command is for master device to retrieve PSU's module model name.

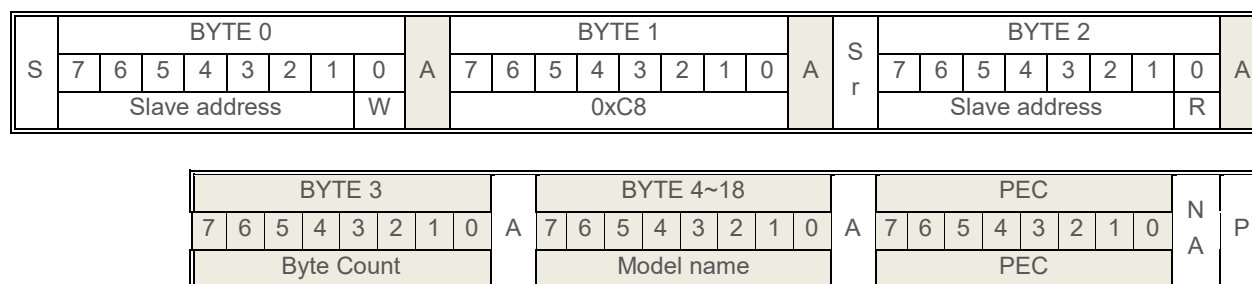

Range:

Model name: 15 bytes of ASCII code

Example:

COMMAND	DESCRIPTION
10 C8 11 0F 41 41 41 20 54 34 32 41 32 4B 31 2D 42 45 4D 25	Model name is MEB-1K2A24T AAA

Note:

1. Slave address is assumed to be 0b0001000 in the example.
2. The value returned is the information of selected page, and for multi-output modules, the value is from selected phase.
3. The message is in inverted order, if the version length is smaller than 15, padding the other bytes with 0x20.

Medical / Industrial AC-DC Configurable Power Supply

Up to 2100W / MEG-A series

4.58 Report Module Output Number

This command is for master device to retrieve PSU's module output number.

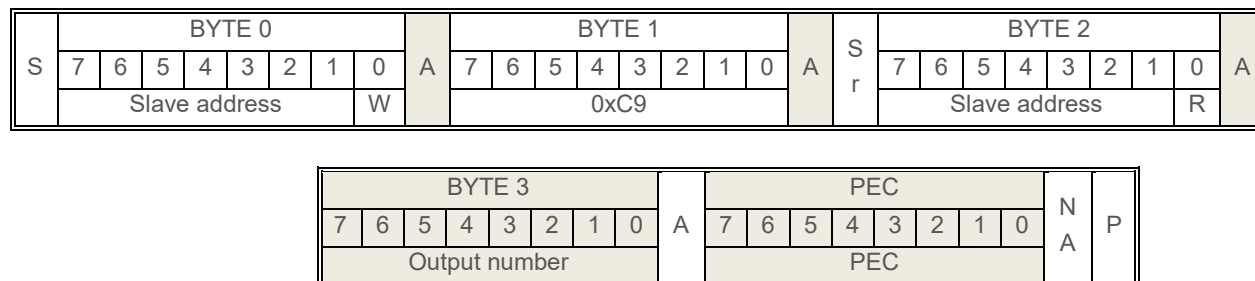

Range:

Output number: 0~255

Example:

COMMAND	DESCRIPTION
10 C9 11 01 95	Output number of current is 1

Note:

1. Slave address is assumed to be 0b0001000 in the example.
2. The value returned is the information of selected page, and for multi-output modules, the value is from selected phase.
3. This command is the output number of each module, not the total output number of the whole product.

4.59 Report Parallel Information

This command is for master device to retrieve PSU's module output number.

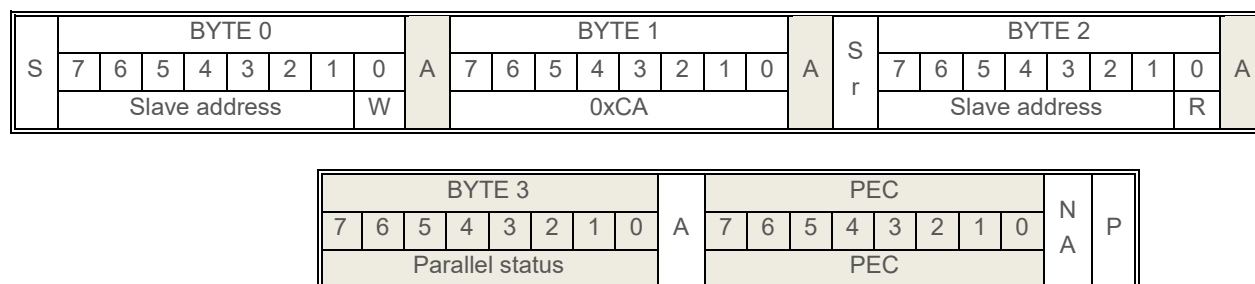

Range:

Parallel status: 0—not parallel, 1—parallel

Example:

COMMAND	DESCRIPTION
10 CA 11 01 28	The parallel status is 1

Note:

1. Slave address is assumed to be 0b0001000 in the example.
2. The value returned is the information of selected page, and for multi-output modules, the value is from selected phase.

Medical / Industrial AC-DC Configurable Power Supply

Up to 2100W / MEG-A series

4.60 Report Max Output Current

This command is for master device to retrieve PSU's max current output.

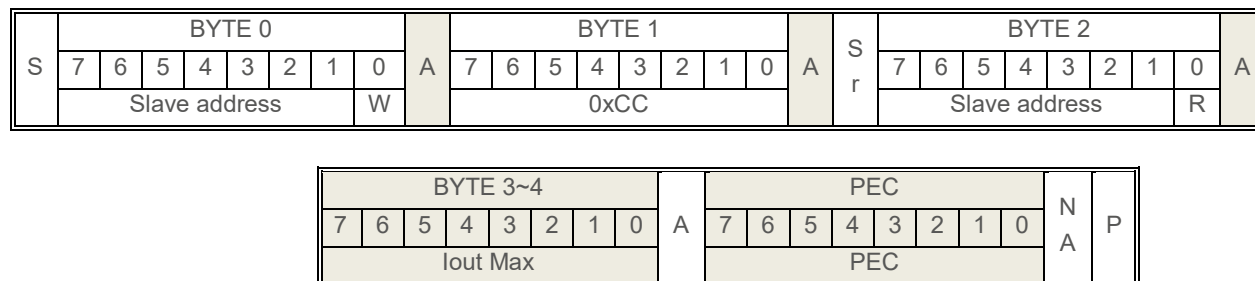

Range:

Iout Max:0~6553.5A

Example:

COMMAND	DESCRIPTION
10 CC 11 96 00 26	The max output current is 15.0A

Note:

- Slave address is assumed to be 0b0001000 in the example.
- Report data has two bytes and accuracy is one decimal place, the unit is Ampere. Low byte is sent first, and then comes after the high byte.
- The value returned is the information of selected page, and for multi-output modules, the value is from selected phase.

4.61 Report Min Output Current

This command is for master device to retrieve PSU's min current output.

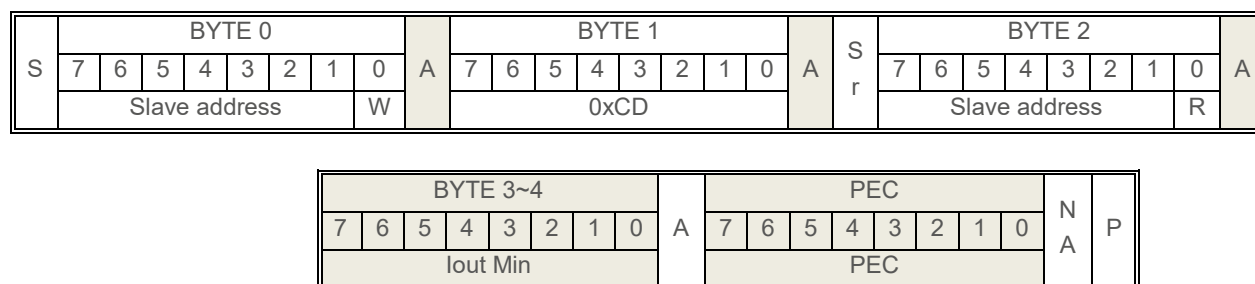

Range:

Iout Min:0~6553.5A

Example:

COMMAND	DESCRIPTION
10 CD 11 96 00 30	The min output current is 15.0A

Note:

- Slave address is assumed to be 0b0001000 in the example.
- Report data has two bytes and accuracy is one decimal place, the unit is Ampere. Low byte is sent first, and then comes after the high byte.
- The value returned is the information of selected page, and for multi-output modules, the value is from selected phase.

Medical / Industrial AC-DC Configurable Power Supply

Up to 2100W / MEG-A series

4.62 Report Remote Control Status

This command is for master device to retrieve PSU's remote control status.

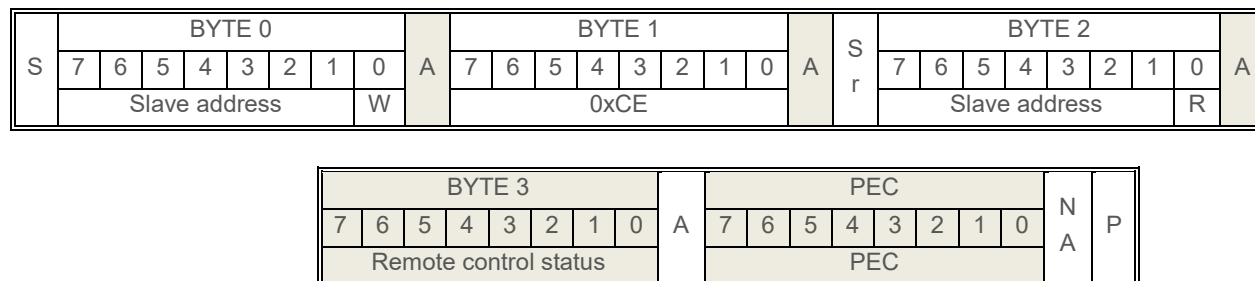

Range:

Remote control status: local—0, remote—1

Example:

COMMAND	DESCRIPTION
10 CE 11 00 84	The module is local control

Note:

- Slave address is assumed to be 0b0001000 in the example.
- The output voltage is controlled by the local VR when the PSU is in local control status, and in remote control, the output voltage can only be modified by the PMBUS
- The value returned is the information of selected phase, and for multi-output modules, the value is from selected phase.

4.63 Report Slot Status

This command is for host to check the slot status.

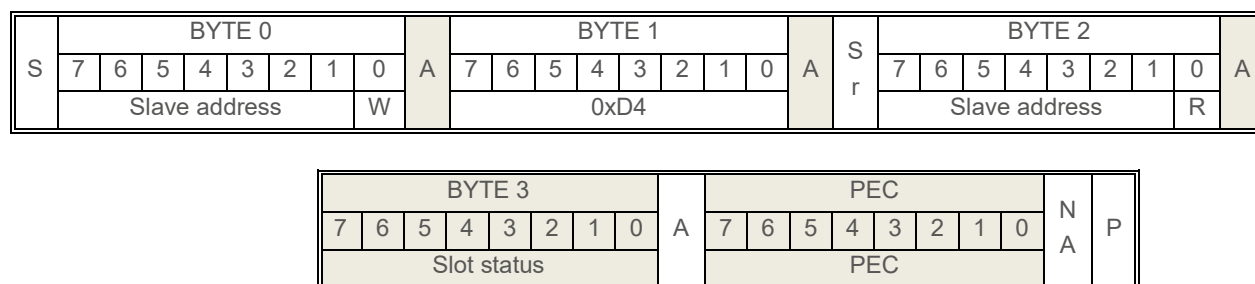

Range:

Byte	Bits	Description	Meaning
Low byte	7	Reserved	
	6	Slot6	0—not connect 1--connect
	5	Slot5	0—not connect 1--connect
	4	Slot4	0—not connect 1--connect
	3	Slot3	0—not connect 1--connect
	2	Slot2	0—not connect 1--connect
	1	Slot1	0—not connect 1--connect
	0	PFC	0—not connect 1--connect
High byte		Reserved	

Medical / Industrial AC-DC Configurable Power Supply

Up to 2100W / MEG-A series

Example:

COMMAND	DESCRIPTION
10 D4 11 7F 00 0F	There is 6 modules connected to this product, no error happen

Note:

1. Slave address is assumed to be 0b0001000 in the example.
2. This command would report the product slot status regardless of the selected page.

4.64 Get Module Status

This command could check the module status in one command; the protocol is shown as below:

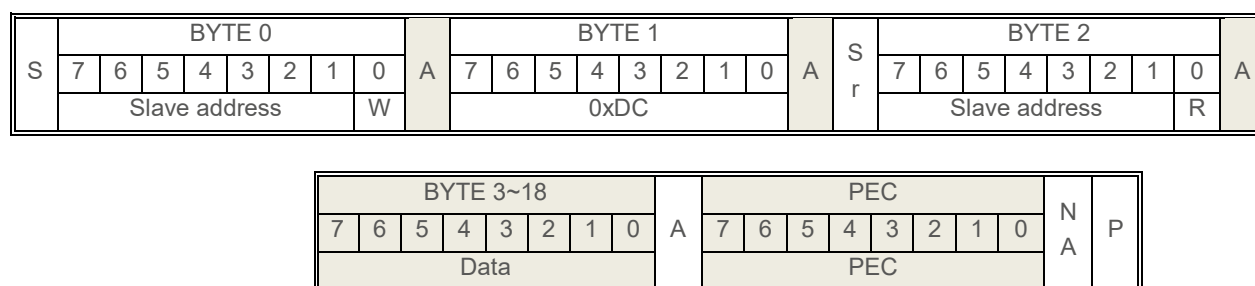

Range:

Byte 3 data length--15

Error bits:

Byte4~5: STATUS_WORD

Byte6: STATUS_VOUT

Byte7: STATUS_IOUT

Byte8: STATUS_TEMPERATURE

Byte9: STATUS_CML

Byte10: STATUS_INPUT

Byte11: STATUS_MFR_SPECIFIC

Byte12: module status

BIT	MEANING
7	Reserved
6	Reserved
5	Reserved
4	Reserved
3	Reserved
2	0 – PFC AC normal / 1 – PFC AC brown out
1	0 – DC remote off / 1 – DC remote on
0	0 – DC not OK/ 1 – DC OK

Byte13~14: Temperature report (-3276.8~3276.7C) (byte 13—low byte)

Byte15~16: output voltage (module only) (byte 15—low byte)

Byte17~18: output current (module only) (byte 17—low byte)

Medical / Industrial AC-DC Configurable Power Supply

Up to 2100W / MEG-A series

Example:

COMMAND	DESCRIPTION
10 DC 11 0F 00 00 00 00 00 00 00 00 00 00 50 00 00 00 00 00 CA	The error bits of this module (address 0x08) is all 0, the temperature is 8.0C, output voltage and current is 0

Note:

1. Slave address is assumed to be 0b0001000 in the example.
2. This command would report the information of the selected page.
3. The coefficients of the report temperature, voltage and current is the same as read temperature, read Vout and read Iout.

4.65 Report Phase

This command serves as an index that can be used by many commands to distinguish between the output of multi-output modules. The valid values for the Page register are from zero to one (0 to 1). The default value is 1.

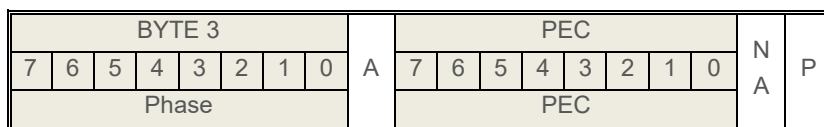
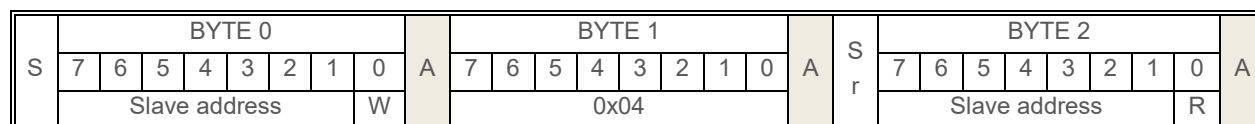

Example:

COMMAND	DESCRIPTION
10 04 11 00 8E	The current selected pphase is 00

Note:

Slave address is assumed to be 0b0001000 in the example.

5 Setting Command

5.1 Clear Faults

This command is for master device to clear PSU's error status.

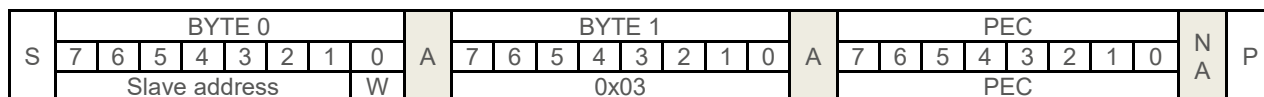

Example:

COMMAND	DESCRIPTION
10 03 5E	Clear all error status

Note:

1. There is no data field in this command.
2. This command would be sent to all the modules regardless of selected page.
3. This command could not reset the latch error.

Medical / Industrial AC-DC Configurable Power Supply

Up to 2100W / MEG-A series

5.2 Set Vout Command

This command is for master device to set PSU's voltage reference.

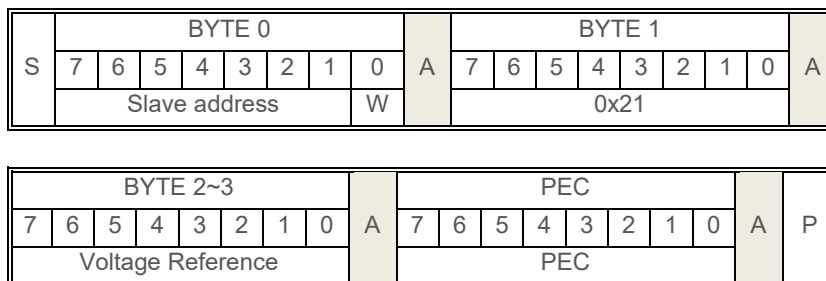

Range:

Variable

Example:

COMMAND	DESCRIPTION
10 21 08 01 E0	Set PSU's voltage reference to 26.4V

Note:

1. Slave address is assumed to be 0b0001000 in the example.
2. Set data has two bytes and accuracy is one decimal place, the unit is Volt. Low byte is sent first, and then comes after the high byte.
3. This command would be sent to the selected page, and for multi-output modules, the value would be sent to selected phase.

5.3 Set Page

This command is only supported by the multichannel power unit, which must be send before send command or retrieve information. The table below is the page number which can be accessed through the Page command. The valid values for the Page register are from zero to six (0 to 6).

Module Position	Page number
Frame	0
DC/DC slot 1	1
DC/DC slot 2	2
DC/DC slot 3	3
DC/DC slot 4	4
DC/DC slot 5	5
DC/DC slot 6	6

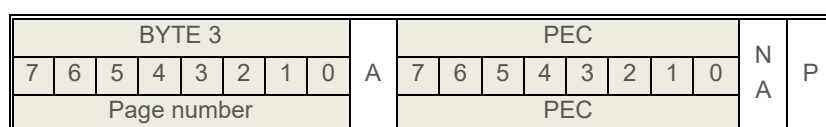
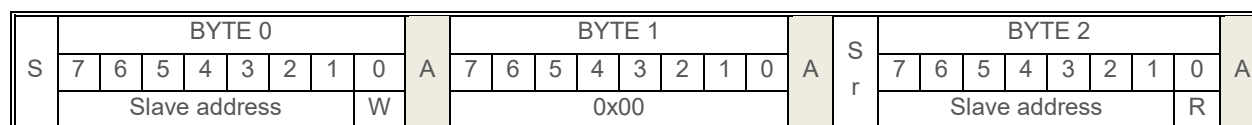

Medical / Industrial AC-DC Configurable Power Supply

Up to 2100W / MEG-A series

Example:

COMMAND	DESCRIPTION
10 00 00 A2	Change the active page to 0

Note:

1. Slave address is assumed to be 0b0001000 in the example.
2. If there is no module set in the selected page, the page number would not be changed.

5.4 Operation

This function is for master device to turn the module on or off.

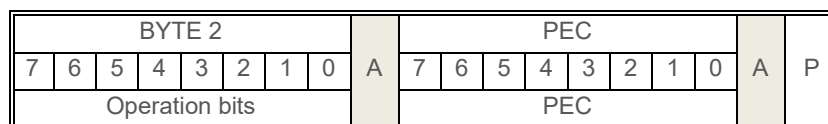
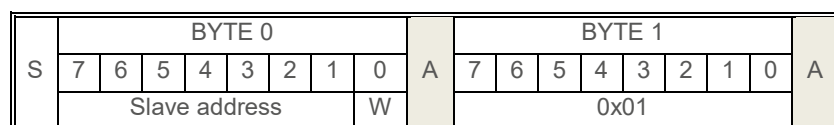
**Range:**

Operation bits:

BITS	MEANING
7	ON/OFF State:0—OFF 1--ON
6	Reserved
5	Reserved
4	Reserved
3	Reserved
2	Reserved
1	Reserved
0	Reserved

Example:

COMMAND	DESCRIPTION
10 01 00 B7	Turn off the module

Note:

1. Slave address is assumed to be 0b0001000 in the example.
2. This command would be sent to the selected page, and for multi-output modules, the value would be sent to selected phase.

Medical / Industrial AC-DC Configurable Power Supply

Up to 2100W / MEG-A series

5.5 Page Plus Write

The page plus write command is used to set the page within a device, send a command, and read the data for the command in one packet without send a page command first.

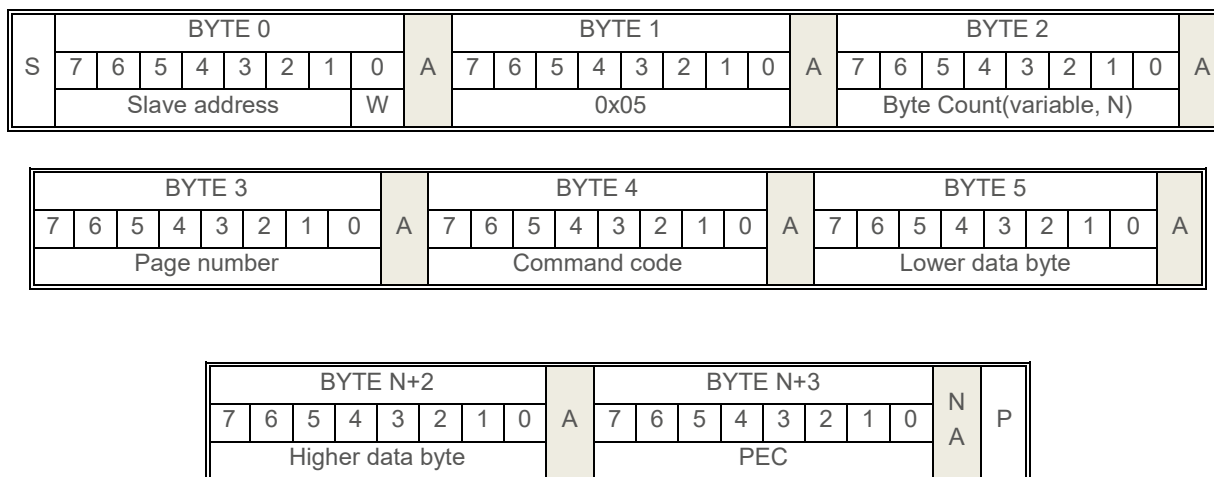

Example:

COMMAND	DESCRIPTION
10 05 04 01 21 C8 00 AA	Set the slot 1 output voltage to 20.0V

Note:

- Slave address is assumed to be 0b0001000 in the example.
- Report data has two bytes and accuracy is one decimal place, the unit is Volt. Low byte is sent first, and then comes after the high byte.
- The value returned is the information of selected page, and for multi-output modules, the value is from selected phase and would not change the current selected page and phase.

5.6 Write Protect

The write protect command is used to control writing to the PMBus device. The intent of this command is to provide protection against accidental changes. The command is described as below;

Range:

Write protect bits

Data byte	Description
1000 0000	Disable all writes except to the WRITE_PROTECT command
0100 0000	Disable all writes except to the WRITE_PROTECT, OPERATION and PAGE commands
0010 0000	Disable all writes except to the WRITE_PROTECT, OPERATION, PAGE, ON_OFF_CONFIG and VOUT_COMMAND commands
0000 0000	Enable writes to all commands

Example:

COMMAND	DESCRIPTION
10 10 00 F5	Enable writes to all commands

Note:

- Slave address is assumed to be 0b0001000 in the example.
- This command would change all the modules writing status regardless of the selected page.

Medical / Industrial AC-DC Configurable Power Supply

Up to 2100W / MEG-A series

5.7 Store Default All

The store default all command instructs the PMBus device to copy the entire contents of the operating memory to the matching locations in the non-volatile Default Store memory.

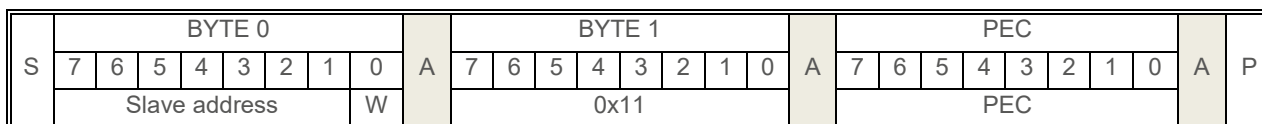

Example:

COMMAND	DESCRIPTION
10 11 20	Copy the entire contents of the operating memory to the matching locations in the non-volatile default store memory

Note:

1. Slave address is assumed to be 0b0001000 in the example.
2. This command would copy the entire contents of all the page regardless of the selected page.

5.8 Restore Default All

The restore default all command instructs the PMBus device to copy the entire contents of the default memory to the matching locations in the operate memory.

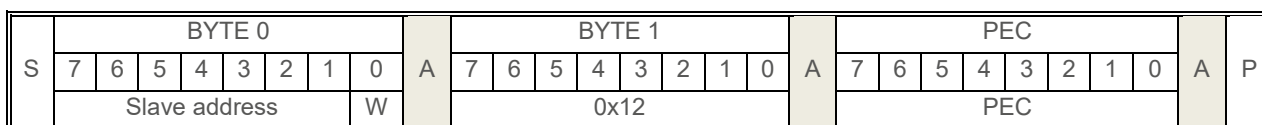

Example:

COMMAND	DESCRIPTION
10 12 29	Copy the entire contents of the default memory to the matching locations in the operate memory.

Note:

1. Slave address is assumed to be 0b0001000 in the example.
2. This command would copy the entire contents of all the page regardless of the selected page.

Medical / Industrial AC-DC Configurable Power Supply

Up to 2100W / MEG-A series

5.9 Store Default Code

The Store Default Code command instructs the PMBus device to copy the parameter whose Command Code matches the value in the data byte, from the operating memory to the matching location in the non-volatile default store memory.

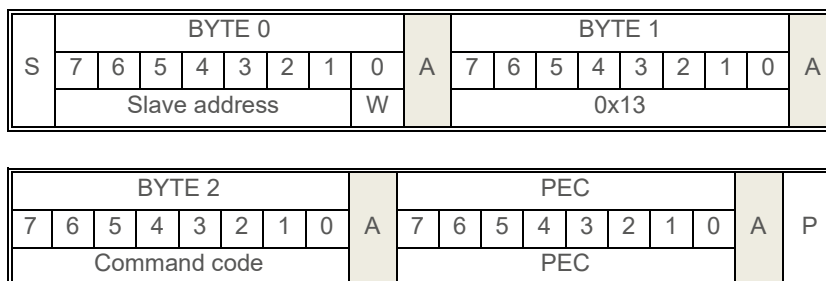

Example:

COMMAND	DESCRIPTION
10 13 21 2D	Copy the Vout command value of selected page to the default memory.

Note:

1. Slave address is assumed to be 0b0001000 in the example.
2. This command would copy the contents of selected page.

5.10 Restore Default Code

The restore default code command instructs the device to copy the parameter whose command code matches the value in the data byte from the non-volatile default store memory to the matching location in the operating memory. The value in the operating memory is overwritten by the value retrieved from the default store.

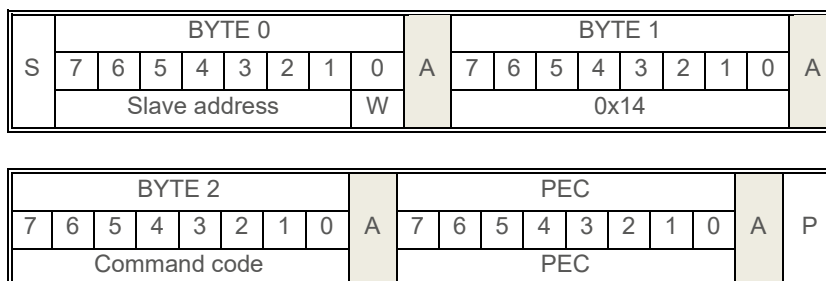

Example:

COMMAND	DESCRIPTION
10 14 21 46	Copy the Vout command value of selected page from default to the operating memory.

Note:

1. Slave address is assumed to be 0b0001000 in the example.
2. This command would copy the contents of selected page.

Medical / Industrial AC-DC Configurable Power Supply

Up to 2100W / MEG-A series

5.11 Store User All

The store user all command instructs the PMBus device to copy the entire contents of the operating memory to the matching locations in the non-volatile user store memory.

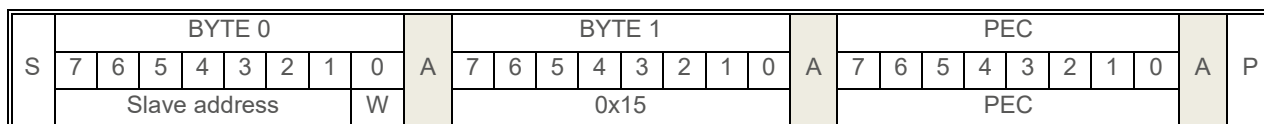

Example:

COMMAND	DESCRIPTION
10 15 3C	Copy the entire contents of the operating memory to the matching locations in the non-volatile user store memory

Note:

1. Slave address is assumed to be 0b0001000 in the example.
2. This command would copy the entire contents of all the page regardless of the selected page.

5.12 Restore User All

The restore user all command instructs the PMBus device to copy the entire contents of the non-volatile user store memory to the matching locations in the operating memory.

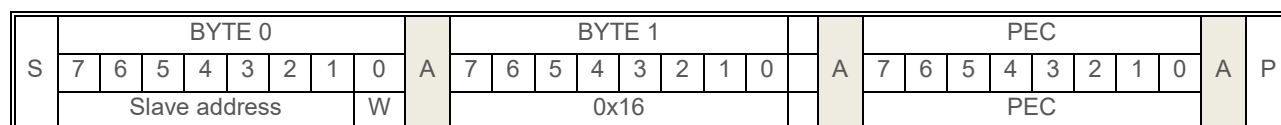

Example:

COMMAND	DESCRIPTION
10 16 35	copy the entire contents of the non-volatile User Store memory to the matching locations in the Operating Memory

Note:

1. Slave address is assumed to be 0b0001000 in the example.
2. This command would copy the entire contents of all the page regardless of the selected page.

Medical / Industrial AC-DC Configurable Power Supply

Up to 2100W / MEG-A series

5.13 Store User Code

The store user code command instructs the PMBus device to copy the parameter whose command code matches value in the data byte from the operating memory to the matching location in the non-volatile user store memory.

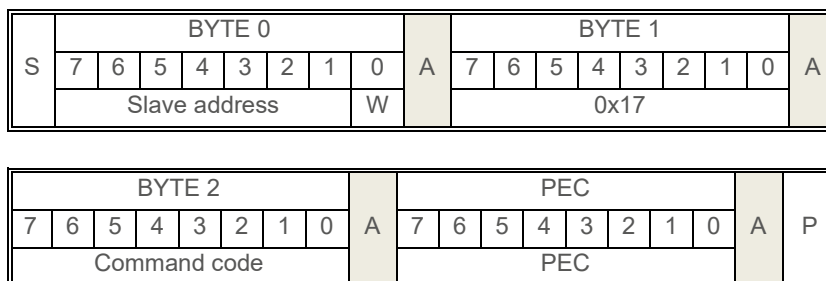

Example:

COMMAND	DESCRIPTION
10 17 21 79	Copy the Vout command value of selected page from operating memory to the user memory.

Note:

1. Slave address is assumed to be 0b0001000 in the example.
2. This command would copy the contents of selected page.

5.14 Restore User Code

The restore user code command instructs the PMBus device to copy the parameter whose command code matches the value in the data byte from the non-volatile user store memory to the matching location in the operating memory. The value in the operating memory is overwritten by the value retrieved from the user store.

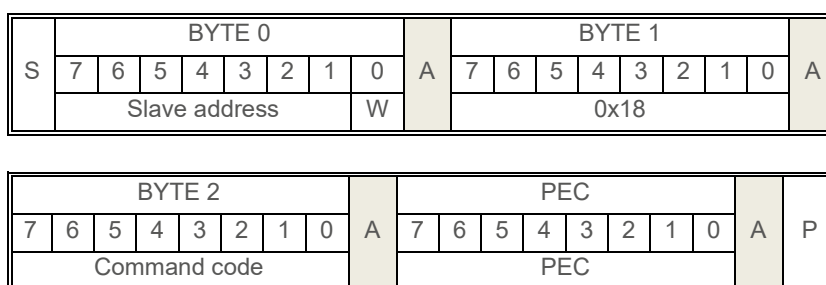

Example:

COMMAND	DESCRIPTION
10 18 21 BA	Copy the Vout command value of selected page from user memory to the operating memory.

Note:

1. Slave address is assumed to be 0b0001000 in the example.
2. This command would copy the contents of selected page.

Medical / Industrial AC-DC Configurable Power Supply

Up to 2100W / MEG-A series

5.15 Remote Control

This command is for master device to set PSU's remote/local control.

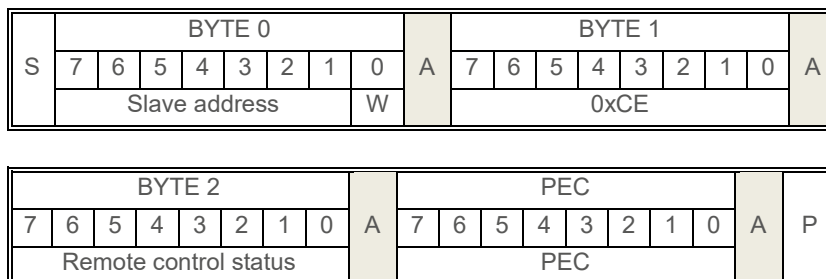

Range:

Remote control status: local—0, remote—1

Example:

COMMAND	DESCRIPTION
10 CE 00 99	Change the control type to local

Note:

1. Slave address is assumed to be 0b0001000 in the example.
2. The output voltage is controlled by the local VR when the PSU is in local control status, and in remote control, the output voltage can only be modified by the PMBUS.
3. This command would be sent to the selected page, and for multi-output modules, the value would be sent to selected phase.

5.16 Set Fan Command 1/2

This command is for master device to set PSU's fan duty value.

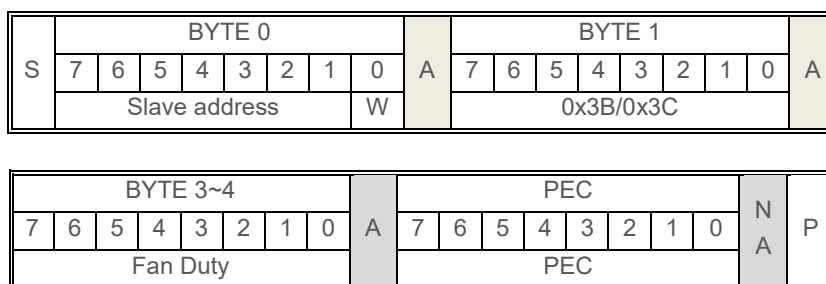

Example:

COMMAND	DESCRIPTION
10 3B 2C 01 3F	Set fan 1 current duty to 30.0%

Note:

1. Slave address is assumed to be 0b0001000 in the example.
2. The set fan command should be larger than the internal temperature loop output, or the PSU internal temperature would be too high to effect the function. So if the set fan speed is smaller the temperature loop output, the INVALID_DATA bit of STATUS_CML would be set, and the PSU would reject this command.
3. This command is to set the PSU fan speed regardless of selected page.

Medical / Industrial AC-DC Configurable Power Supply

Up to 2100W / MEG-A series

5.17 Set Phase

This command is only supported by the multi-outputs power unit, which must be set before sending command or retrieve information. The valid values for the Phase register are from zero to one (0 to 1).

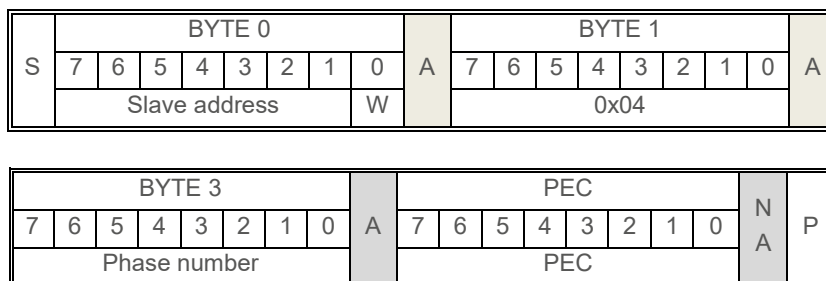

Example:

COMMAND	DESCRIPTION
10 04 00 F6	Set phase to 0

Note:

1. Slave address is assumed to be 0b0001000 in the example.
2. This command is only for multi-outputs channel, a CML error would be reported when single output module received.
3. This command is to set the phase of selected page.

5.18 Set Iout Max

This command is for user to change the max output current limit.

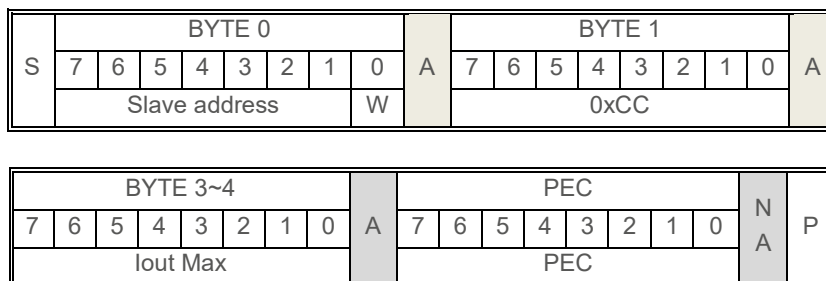

Example:

COMMAND	DESCRIPTION
10 CC 32 00 C3	Set the max output current to 5A

Note:

1. Slave address is assumed to be 0b0001000 in the example.
2. Set data has two bytes and accuracy is one decimal place, the unit is Ampere. Low byte is sent first, and then comes after the high byte.
3. This command would be sent to the selected page, and for multi-output modules, the value would be sent to selected phase..

6 PEC Calculation

The PEC calculation method is CRC8 ($P(x) = x^8 + x^2 + x + 1$). Take command 5301065046434F4E20 for example, the CRC8 result is AD

hi_crc()={00, 70, e0, 90, c7, b7, 27, 57, 89, f9, 69, 19, 4e, 3e, ae, de}

lo_crc()={00, 07, 0e, 09, 1c, 1b, 12, 15, 38, 3f, 36, 31, 24, 23, 2a, 2d}

1. Divided command 5301065046434F4E20 to nine bytes as 53 01 06 50 46 43 4F 4E 20
2. Define pec = 0; abvalue = 53 (the first byte)
3. pec XOR abvalue, the result is 0101 0011. High byte = 5, low byte = 3.
4. Check the array above, hi_crc(5) = B7; lo_crc(3) = 09. B7 XOR 09 = 1011 1110 = pec.
5. abvalue = 01(the second byte in the command) and return to step 3.
6. When all the bytes in the command are finished, the crc8 result is pec.